

# User Manual



## **MTS400 Series MPEG Test Systems**

**Volume 1 of 2**

**071-1507-04**

This document applies to firmware version 1.4  
and above.

**[www.tektronix.com](http://www.tektronix.com)**

Copyright © Tektronix. All rights reserved. Licensed software products are owned by Tektronix or its subsidiaries or suppliers, and are protected by national copyright laws and international treaty provisions.

Tektronix products are covered by U.S. and foreign patents, issued and pending. Information in this publication supercedes that in all previously published material. Specifications and price change privileges reserved.

TEKTRONIX and TEK are registered trademarks of Tektronix, Inc.

## **Contacting Tektronix**

Tektronix, Inc.  
14200 SW Karl Braun Drive  
P.O. Box 500  
Beaverton, OR 97077  
USA

For product information, sales, service, and technical support:

- In North America, call 1-800-833-9200.
- Worldwide, visit [www.tektronix.com](http://www.tektronix.com) to find contacts in your area.

## Warranty 2

Tektronix warrants that this product will be free from defects in materials and workmanship for a period of one (1) year from the date of shipment. If any such product proves defective during this warranty period, Tektronix, at its option, either will repair the defective product without charge for parts and labor, or will provide a replacement in exchange for the defective product. Parts, modules and replacement products used by Tektronix for warranty work may be new or reconditioned to like new performance. All replaced parts, modules and products become the property of Tektronix.

In order to obtain service under this warranty, Customer must notify Tektronix of the defect before the expiration of the warranty period and make suitable arrangements for the performance of service. Customer shall be responsible for packaging and shipping the defective product to the service center designated by Tektronix, with shipping charges prepaid. Tektronix shall pay for the return of the product to Customer if the shipment is to a location within the country in which the Tektronix service center is located. Customer shall be responsible for paying all shipping charges, duties, taxes, and any other charges for products returned to any other locations.

This warranty shall not apply to any defect, failure or damage caused by improper use or improper or inadequate maintenance and care. Tektronix shall not be obligated to furnish service under this warranty a) to repair damage resulting from attempts by personnel other than Tektronix representatives to install, repair or service the product; b) to repair damage resulting from improper use or connection to incompatible equipment; c) to repair any damage or malfunction caused by the use of non-Tektronix supplies; or d) to service a product that has been modified or integrated with other products when the effect of such modification or integration increases the time or difficulty of servicing the product.

THIS WARRANTY IS GIVEN BY TEKTRONIX WITH RESPECT TO THE PRODUCT IN LIEU OF ANY OTHER WARRANTIES, EXPRESS OR IMPLIED. TEKTRONIX AND ITS VENDORS DISCLAIM ANY IMPLIED WARRANTIES OF MERCHANTABILITY OR FITNESS FOR A PARTICULAR PURPOSE. TEKTRONIX' RESPONSIBILITY TO REPAIR OR REPLACE DEFECTIVE PRODUCTS IS THE SOLE AND EXCLUSIVE REMEDY PROVIDED TO THE CUSTOMER FOR BREACH OF THIS WARRANTY. TEKTRONIX AND ITS VENDORS WILL NOT BE LIABLE FOR ANY INDIRECT, SPECIAL, INCIDENTAL, OR CONSEQUENTIAL DAMAGES IRRESPECTIVE OF WHETHER TEKTRONIX OR THE VENDOR HAS ADVANCE NOTICE OF THE POSSIBILITY OF SUCH DAMAGES.

### **Warranty 9(b)**

Tektronix warrants that the media on which this software product is furnished and the encoding of the programs on the media will be free from defects in materials and workmanship for a period of three (3) months from the date of shipment. If any such medium or encoding proves defective during the warranty period, Tektronix will provide a replacement in exchange for the defective medium. Except as to the media on which this software product is furnished, this software product is provided "as is" without warranty of any kind, either express or implied. Tektronix does not warrant that the functions contained in this software product will meet Customer's requirements or that the operation of the programs will be uninterrupted or error-free.

In order to obtain service under this warranty, Customer must notify Tektronix of the defect before the expiration of the warranty period. If Tektronix is unable to provide a replacement that is free from defects in materials and workmanship within a reasonable time thereafter, Customer may terminate the license for this software product and return this software product and any associated materials for credit or refund.

THIS WARRANTY IS GIVEN BY TEKTRONIX WITH RESPECT TO THE PRODUCT IN LIEU OF ANY OTHER WARRANTIES, EXPRESS OR IMPLIED. TEKTRONIX AND ITS VENDORS DISCLAIM ANY IMPLIED WARRANTIES OF MERCHANTABILITY OR FITNESS FOR A PARTICULAR PURPOSE. TEKTRONIX' RESPONSIBILITY TO REPLACE DEFECTIVE MEDIA OR REFUND CUSTOMER'S PAYMENT IS THE SOLE AND EXCLUSIVE REMEDY PROVIDED TO THE CUSTOMER FOR BREACH OF THIS WARRANTY. TEKTRONIX AND ITS VENDORS WILL NOT BE LIABLE FOR ANY INDIRECT, SPECIAL, INCIDENTAL, OR CONSEQUENTIAL DAMAGES IRRESPECTIVE OF WHETHER TEKTRONIX OR THE VENDOR HAS ADVANCE NOTICE OF THE POSSIBILITY OF SUCH DAMAGES.



# Table of Contents

General Safety Summary	iii
Service Safety Summary	v
Preface	vii
Related Material	vii
Manual Conventions	viii

## Volume 1

<b>Introduction</b>	<b>1</b>
<b>Transport Stream Compliance Analyzer</b>	<b>2</b>
<b>PES Analyzer</b>	<b>3</b>
<b>T-STD Buffer Analyzer</b>	<b>4</b>
<b>Elementary Stream Analyzer</b>	<b>5</b>

## Volume 2

<b>Carousel Analyzer</b>	<b>6</b>
<b>Carousel Generator</b>	<b>7</b>
<b>Multiplexer</b>	<b>8</b>
<b>Transport Stream Editor</b>	<b>9</b>
<b>MPEG Player</b>	<b>10</b>
<b>Make Seamless Wizard</b>	<b>11</b>
<b>TS Cutter</b>	<b>12</b>
<b>Script Pad</b>	<b>13</b>



# General Safety Summary

Review the following safety precautions to avoid injury and prevent damage to this product or any products connected to it.

To avoid potential hazards, use this product only as specified.

*Only qualified personnel should perform service procedures.*

## **To Avoid Fire or Personal Injury**

**Use Proper Power Cord.** Use only the power cord specified for this product and certified for the country of use.

**Ground the Product.** This product is grounded through the grounding conductor of the power cord. To avoid electric shock, the grounding conductor must be connected to earth ground. Before making connections to the input or output terminals of the product, ensure that the product is properly grounded.

**Observe All Terminal Ratings.** To avoid fire or shock hazard, observe all ratings and markings on the product. Consult the product manual for further ratings information before making connections to the product.

**Power Disconnect.** The power cord disconnects the product from the power source. Do not block the power cord; it must remain accessible to the user at all times.

**Do Not Operate Without Covers.** Do not operate this product with covers or panels removed.

**Do Not Operate With Suspected Failures.** If you suspect there is damage to this product, have it inspected by qualified service personnel.

**Avoid Exposed Circuitry.** Do not touch exposed connections and components when power is present.

**Use Proper Fuse.** Use only the fuse type and rating specified for this product.

**Do Not Operate in Wet/Damp Conditions.**

**Do Not Operate in an Explosive Atmosphere.**

**Keep Product Surfaces Clean and Dry.**

**Provide Proper Ventilation.** Refer to the manual's installation instructions for details on installing the product so it has proper ventilation.

**Terms in this Manual**

These terms may appear in this manual:



---

**WARNING.** *Warning statements identify conditions or practices that could result in injury or loss of life.*

---



---

**CAUTION.** *Caution statements identify conditions or practices that could result in damage to this product or other property.*

---

**Symbols and Terms on the Product**

These terms may appear on the product:

- DANGER indicates an injury hazard immediately accessible as you read the marking.
- WARNING indicates an injury hazard not immediately accessible as you read the marking.
- CAUTION indicates a hazard to property including the product.

The following symbols may appear on the product:



# Service Safety Summary

Only qualified personnel should perform service procedures. Read this *Service Safety Summary* and the *General Safety Summary* before performing any service procedures.

**Do Not Service Alone.** Do not perform internal service or adjustments of this product unless another person capable of rendering first aid and resuscitation is present.

**Disconnect Power.** To avoid electric shock, switch off the instrument power, then disconnect the power cord from the mains power.

**Use Care When Servicing With Power On.** Dangerous voltages or currents may exist in this product. Disconnect power, remove battery (if applicable), and disconnect test leads before removing protective panels, soldering, or replacing components.

To avoid electric shock, do not touch exposed connections.

Use only Tektronix approved components when servicing the unit.



# Preface

This manual describes the functions and use of the Tektronix MTS400 Series MPEG Test System. After the introduction, each section of the manual describes one of the software applications or tools that make up the MTS400 Series system.

Other documents are available on the Tektronix Web site ([www.tektronix.com](http://www.tektronix.com)):

- *MTS400 Series MPEG Test System Getting Started Manual (071-1505-xx).*
- *MTS400 Series MPEG Test System Programmer Manual (071-1725-xx).*  
This manual specifies the remote control and status monitoring interfaces available to a management application.

## Related Material

Additional documentation, such as Read Me files, may be included on the installation disks.

The following URLs access the Web sites for the standards organizations listed (the URLs listed were valid at the time of writing):

- MPEG-2 standards (International Organization for Standards)  
<http://www.iso.ch/>
- DVB standards (European Technical Standards Institute)  
<http://www.etsi.org/>
- ATSC standards (Advanced Television Systems Committee)  
<http://www.atsc.org/>
- ISDB/ARIB standards (Association of Radio Industries and Businesses)  
<http://www.arib.or.jp/english/>
- SCTE Society of Cable Television Engineers  
<http://www.scte.org/>

## Manual Conventions

Naming conventions for the interface elements are based on standard Microsoft Windows naming conventions. Naming conventions for MPEG-2, ATSC, and DVB structures follow the conventions derived from the standards listed above. In addition, the following formatting conventions apply to this manual:

- **Bold** text refers to specific interface elements that you are instructed to select, click, or clear.  
Example: Select **Settings** from the Configuration menu.
- Mono-spaced text can indicate the following:
  - Text you enter from a keyboard  
Example: Enter the network identity (`http://TSMonitor01`)
  - Characters you press on your keyboard  
Example: Press CTRL+C to copy the selected text.
  - Paths to components on your hard drive  
Example: The program files are installed at the following location:  
`C:\Program Files\Tektronix\`





# Introduction



# Introduction





Table 1–1 summarizes the software applications that make up the MTS400 Series MPEG Test Systems. Options are enabled by a software key; not all options may be enabled. Detailed descriptions of all applications can be found in the remainder of this manual.

See also the *MTS400 Series MPEG Test Systems Getting Started manual* (071-1507-xx).







The MTS4EA Compressed Video ES Analyzer options are described in the *MTS4EA User Manual* (071-1641-xx).

(The applications are shown in the same order that they appear in the Windows Start menu.)



**Table 1–1: MTS430 / MTS400 / MTS4SA / MTS4UP / MTX100B Installed Applications**

Application	Desktop Icon (where installed)
<b>Analyzers</b>	
Transport Stream Compliance Analyzer (TSCA) - Real Time  Real-time transport stream analysis with user-selectable MPEG-2, DVB, ATSC and ISDB conformance tests. Shows transport structure, header contents, hexadecimal packet contents, PCR timing /transport rate graphs and error message logs.	 TS Compliance Analyser
Transport Stream Compliance Analyzer (TSCA) - Deferred  Deferred transport stream analysis with user-selectable MPEG-2, DVB, ATSC and ISDB conformance tests. Shows transport structure, header contents, hexadecimal packet contents, PCR timing /transport rate graphs and error message logs.	 TS Compliance Analyser
Transport Stream Compliance Analyzer Lite (TSCA) - Deferred  Same as for the TS Analyzer except that the file size of transport streams to be analyzed is limited to 192 MB.	 TS Compliance Analyser
Packetized Elementary Stream (PES) Analyzer  PES analysis with selectable test options. Shows PES program structure, header contents, packet contents, PTS/DTS timing graphs and analysis reports.	 PES Analyser

**Table 1-1: MTS430 / MTS400 / MTS4SA / MTS4UP / MTX100B Installed Applications (Cont.)**

<b>Application</b>	<b>Desktop Icon (where installed)</b>
<p>Transport Stream - System Target Decoder (T-STD) Buffer Analyzer</p> <p>Analyzes program streams modeling their behavior in, and their conformance to, the MPEG 2 T STD Buffer Model.</p>	 Buffer Analyser
<p>Elementary Stream Analyzer</p> <p>Elementary Stream analysis at video picture and audio level. This includes vector graphs and macroblock picture quality.</p>	 ES Analyser
<p>Carousel Analyzer</p> <p>Data analysis showing structure, bit rate, repetition rate, syntax and semantics of data items.</p>	 Carousel Analyser
<b>Generators</b>	
<p>Carousel Generator</p> <p>Provides in-depth off-line generation of MPEG-2, DVB transport streams containing a range of data broadcast protocols.</p>	 Carousel Generator
<p>Multiplexer</p> <p>Multiplexes table information and packetized elementary streams together to synthesize new transport streams. A fine level of control is provided to allow non-conformances and test cases to be specified for new transport streams.</p>	 Multiplexer
<p>TS Editor</p> <p>Viewing and Editing of transport stream packets, using a hexadecimal view of the packet contents and semantic interpretation of the header. Provides facilities to remap PIDs, recalculate PCR values, and introduce PCR inaccuracies.</p>	 TS Editor
<b>Players</b>	
<p>MPEG Player</p> <p>Records and Plays out MPEG-2 streams.</p> <p>(The MTX100B MPEG Player and Recorder is described in the MTX100B User Manual, Tektronix part number 071-1927-xx.)</p>	 MPEG Player

**Table 1-1: MTS430 / MTS400 / MTS4SA / MTS4UP / MTX100B Installed Applications (Cont.)**

<b>Application</b>	<b>Desktop Icon (where installed)</b>
<b>Utilities</b>	
Make Seamless Wizard Guides the user through the process of creating an MPEG-2 file for use by Stream Player in continuously looped operation.	 Make Seamless Wizard
Stream Cutter Extracts sections of MPEG-2 files to new files.	 Stream Cutter
Script Pad Enables users to create and modify System Information (SI) scripts.	 ScriptPad





# **Transport Stream Compliance Analyzer**





# Table of Contents

<b>Transport Stream Compliance Analyzer - Getting Started</b> .....	<b>2-1</b>
TSCA Features .....	2-2
Deferred and Real-Time Modes .....	2-2
Technical Background .....	2-3
User Interface .....	2-3
CaptureVu Feature .....	2-5
Triggered Recording .....	2-5
Starting the TSCA Software .....	2-6
Setting Up the IP Interface .....	2-13
Setting the Stream Content Font .....	2-18
<b>Understanding the Analyzer Window</b> .....	<b>2-21</b>
TSCA Window Components .....	2-22
Error Status LEDs .....	2-26
Shortcut Menus .....	2-27
<b>Using the Program View</b> .....	<b>2-29</b>
Program Navigation - Transport Stream Node .....	2-31
Program Navigation - Program Nodes .....	2-37
Program Navigation - Elementary Stream Node .....	2-39
<b>Using the Tests View</b> .....	<b>2-43</b>
Tests Navigation - All Tests .....	2-47
Test Navigation - Test Nodes .....	2-48
Test Navigation - PID Nodes .....	2-49
<b>Using the Tables View</b> .....	<b>2-51</b>
Table Summary Pane .....	2-52
Tables Detail View - Section View .....	2-53
Tables Detail View - SI Repetition Graphs .....	2-55
<b>Using the PID View</b> .....	<b>2-57</b>
PID View - All PIDs .....	2-58
PID View - Detail View (All PID and PID Group) .....	2-59
PID View - Detail View (PIDs) .....	2-60
<b>Using the Packets View</b> .....	<b>2-63</b>
Packet Navigation Bar .....	2-64
Packet Navigation - Filter Nodes .....	2-65
Packet Detail View .....	2-66
<b>Using the Interface View</b> .....	<b>2-69</b>
Detail View Tabs .....	2-70
Readings and Controls .....	2-70
RF Interface Card Overview .....	2-71
RF Interface View Screens .....	2-74
<b>Common User Interface Concepts</b> .....	<b>2-85</b>
Windows Management .....	2-86
Icons .....	2-87
Graph Management .....	2-91
Timing Graphs .....	2-97
Bit Rate Graphs .....	2-101

PIT Graph .....	2-101
Now Playing Views .....	2-102
Parameter Edit .....	2-104
Event Log .....	2-107
Bit Rates .....	2-111
EPG View .....	2-115
MPE Views .....	2-119
CaptureVu Feature .....	2-120
Triggered Recording .....	2-126
Menu Bar and Options .....	2-130
Preferences .....	2-133
Script Files .....	2-135
<b>Task Examples .....</b>	<b>2-141</b>
Which tests have failed in an analyzed stream? .....	2-142
How many PIDs are there in a stream?	
How many PIDs are referenced?	
How many are unreferenced? .....	2-145
What tests have been applied to a program PID? .....	2-146
Establish the stream type of a PID .....	2-147
How many programs are there in the stream? .....	2-148
What are the contents of the programs?	
And what PIDs are they on? .....	2-149
What is the bit rate of each PID in a program? .....	2-150
What is the latest version number	
of the Program Association Table (PAT) in the SI? .....	2-153
Examine a Transport Packet .....	2-154
<b>SI/PSI Nodes .....</b>	<b>2-157</b>

# List of Figures

<b>Figure 2-1: TSCA Program view - Deferred analysis</b> .....	2-1
<b>Figure 2-2: TSCA Start-up</b> .....	2-6
<b>Figure 2-3: Stream Interpretation dialog box</b> .....	2-7
<b>Figure 2-4: TSCA File Analysis (Offline) dialog box</b> .....	2-9
<b>Figure 2-5: TSCA Real-time Analysis dialog box</b> .....	2-11
<b>Figure 2-6: TSCA window showing analysis progress</b> .....	2-12
<b>Figure 2-7: Setting up the IP interface</b> .....	2-13
<b>Figure 2-8: UDP flow selection dialog box</b> .....	2-15
<b>Figure 2-9: Selecting a display font from the Preferences dialog box</b> .....	2-18
<b>Figure 2-10: Analyzer window</b> .....	2-21
<b>Figure 2-11: Analyzer window - no file</b> .....	2-25
<b>Figure 2-12: Shortcut menu (example)</b> .....	2-27
<b>Figure 2-13: Program view</b> .....	2-29
<b>Figure 2-14: Program view nodes</b> .....	2-30
<b>Figure 2-15: Bit rate values display</b> .....	2-34
<b>Figure 2-16: Event log</b> .....	2-35
<b>Figure 2-17: PCR Graphs view</b> .....	2-40
<b>Figure 2-18: Tests Navigation view</b> .....	2-43
<b>Figure 2-19: Test view nodes</b> .....	2-44
<b>Figure 2-20: Test filtering buttons</b> .....	2-46
<b>Figure 2-21: Test Failures screen</b> .....	2-47
<b>Figure 2-22: Tables view</b> .....	2-51
<b>Figure 2-23: Tables view - Programs (example)</b> .....	2-52
<b>Figure 2-24: Section payload</b> .....	2-54
<b>Figure 2-25: PID Summary view</b> .....	2-59
<b>Figure 2-26: PID Information view</b> .....	2-60
<b>Figure 2-27: Packet view - ISDB detail -IIP</b> .....	2-67
<b>Figure 2-28: Packet view - ISDB detail - Transport packet</b> .....	2-68
<b>Figure 2-29: Interface View - Example</b> .....	2-69
<b>Figure 2-30: Open Transport Stream dialog box</b> .....	2-72
<b>Figure 2-31: RF Firmware update</b> .....	2-73
<b>Figure 2-32: Interface View - RF - QAM (Annex B)</b> .....	2-74
<b>Figure 2-33: Interface View - RF - COFDM</b> .....	2-77
<b>Figure 2-34: Interface View - RF - 8VSB</b> .....	2-80
<b>Figure 2-35: Interface View - RF - QPSK/8PSK</b> .....	2-82

Figure 2-36: Window size adjustments .....	2-87
Figure 2-37: Timing graphs .....	2-92
Figure 2-38: Graphs - cursor .....	2-93
Figure 2-39: Graph toolbar .....	2-94
Figure 2-40: Graph Shortcut menu .....	2-95
Figure 2-41: Out of range indicator .....	2-96
Figure 2-42: PCR Drift/Jitter Demarcation Filters dialog box .....	2-99
Figure 2-43: PCR parameters - Filter settings .....	2-100
Figure 2-44: Bit rate graph .....	2-101
Figure 2-45: Now Playing - Thumbnail view .....	2-102
Figure 2-46: Now Playing - Summary view .....	2-103
Figure 2-47: Now Playing - Detail view .....	2-103
Figure 2-48: Test parameters .....	2-104
Figure 2-49: PID test parameters .....	2-105
Figure 2-50: Parameter value - default icon .....	2-106
Figure 2-51: Event log - color coding .....	2-109
Figure 2-52: Event log - shortcut menu - color .....	2-110
Figure 2-53: Event log - color dialog boxes .....	2-110
Figure 2-54: Bit Rate display selection .....	2-111
Figure 2-55: Bar chart .....	2-112
Figure 2-56: Pie chart .....	2-114
Figure 2-57: EPG Summary view .....	2-116
Figure 2-58: EPG nodes .....	2-117
Figure 2-59: MPE view .....	2-119
Figure 2-60: CaptureVu breakpoint - Test view .....	2-123
Figure 2-61: CaptureVu breakpoint - Packet view .....	2-124
Figure 2-62: Record Settings dialog box .....	2-126
Figure 2-63: Record Settings dialog box - Armed state .....	2-129
Figure 2-64: Preferences - General .....	2-133
Figure 2-65: Preferences - Font .....	2-134
Figure 2-66: Preferences - Decode .....	2-135
Figure 2-67: Stream Interpretation dialog box .....	2-136
Figure 2-68: Failed tests - example .....	2-142
Figure 2-69: Program count .....	2-148
Figure 2-70: PID count .....	2-149
Figure 2-71: Program PID bit rate - bar chart .....	2-150
Figure 2-72: Program PID bit rate - pie chart .....	2-151
Figure 2-73: Bit rate graph .....	2-152

## List of Tables

<b>Figure 2–74: Table Identity and Version (summary view) .....</b>	<b>2–153</b>
<b>Figure 2–75: Table Identity and Version (section view) .....</b>	<b>2–154</b>
<b>Figure 2–76: Primary SI/PSI nodes (DVB example) .....</b>	<b>2–157</b>
<b>Table 2–1: Toolbar icons .....</b>	<b>2–22</b>
<b>Table 2–2: Program view tabs .....</b>	<b>2–30</b>
<b>Table 2–3: Object identification icons .....</b>	<b>2–88</b>
<b>Table 2–4: Interface management icons .....</b>	<b>2–89</b>
<b>Table 2–5: Quick link icons .....</b>	<b>2–90</b>
<b>Table 2–6: Timing measurement graphs .....</b>	<b>2–97</b>
<b>Table 2–7: PCR settling times .....</b>	<b>2–100</b>
<b>Table 2–8: File menu options .....</b>	<b>2–130</b>
<b>Table 2–9: Navigation menu options .....</b>	<b>2–131</b>
<b>Table 2–10: Settings menu options .....</b>	<b>2–131</b>
<b>Table 2–11: CaptureVu menu options .....</b>	<b>2–132</b>
<b>Table 2–12: Record menu options .....</b>	<b>2–132</b>
<b>Table 2–13: Help menu options .....</b>	<b>2–133</b>
<b>Table 2–14: Bit rate views .....</b>	<b>2–150</b>
<b>Table 2–15: MPEG SI/PSI .....</b>	<b>2–158</b>
<b>Table 2–16: DVB SI/PSI .....</b>	<b>2–158</b>
<b>Table 2–17: ATSC SI/PSI .....</b>	<b>2–159</b>
<b>Table 2–18: ISDB-S SI/PSI nodes .....</b>	<b>2–160</b>
<b>Table 2–19: ISDB-T SI/PSI nodes .....</b>	<b>2–161</b>



# Transport Stream Compliance Analyzer - Getting Started

The MTS400 MPEG Transport Stream Compliance Analyzer (TSCA) enables you to monitor and interpret the contents of real-time, previously recorded or synthesized transport streams using the latest MPEG, DVB, ATSC, ISDB-T, and ISDB-S standards.

The TSCA is specifically designed to enable you to quickly locate and identify problems within a transport stream using a minimum number of mouse clicks. By quickly identifying the problem areas, the TSCA software helps you save time during the development and test of equipment, networks, and services. You can configure the TSCA software to display stream information in user-selected fonts. This feature enables you to view stream information in your local language or to use custom fonts.

The TSCA software will run stand-alone on computers with Microsoft Windows 2000 or Windows XP operating systems.

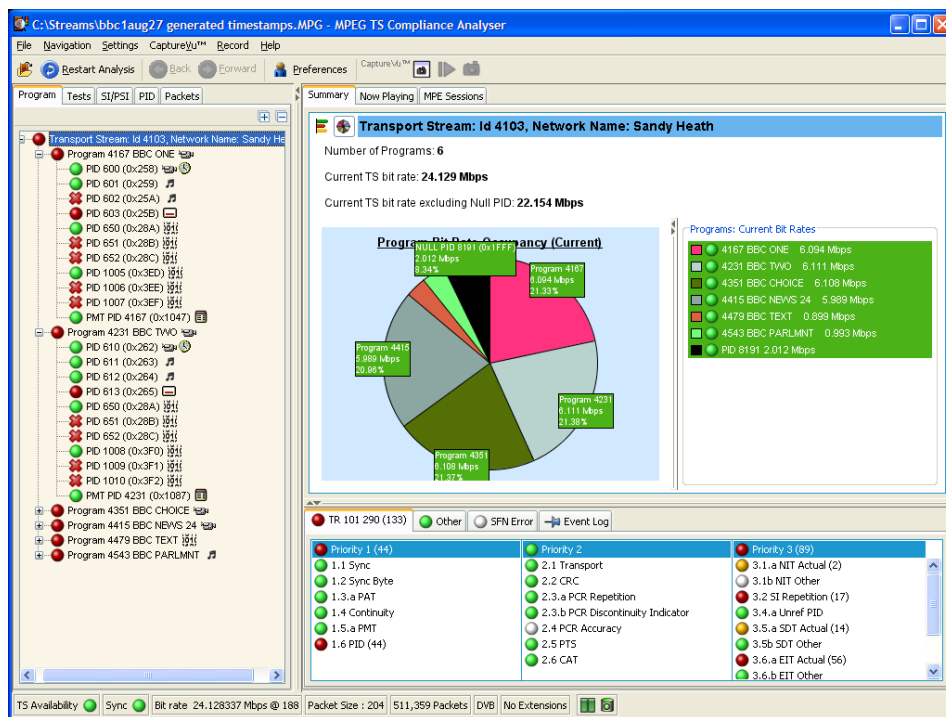

Figure 2-1: TSCA Program view - Deferred analysis

## TSCA Features

- Easy “program centric” user interface quickly isolates information of interest
- CaptureVu™ technology captures and analyzes system events in real or deferred time
- In-depth analysis of stored transport streams including support for MPEG, ATSC, DVB, ISDB-T and ISDB-S table types
- Data summaries and automated filters simplify the analysis of complex transport streams
- TR 101 290 Priority 1, 2 and 3 tests  
(European Telecommunications Standards Institute (ETSI) TR 101 290: Digital Video Broadcasting (DVB); Measurement Guidelines for DVB Systems.)
- Syntax analysis and display supported for TMCC and IIP data
- Consistency checks performed between SI, TMCC, and IIP data
- Proprietary PSI/SI syntax section rate error testing
- Error logging
- Suspension of all tests at program changeover based on PMT version change
- DII and DDB error checking

## Deferred and Real-Time Modes

The TSCA can be run in Deferred or Real-Time mode.

The Deferred mode is available on any recommended platform (including the user’s own PC). In Deferred mode, a static stream can be analyzed and displayed; the content can then be inspected at leisure.

The Real-time mode, with which a live stream can be analyzed, is available when the TSCA is installed on a Tektronix MTS400 series MPEG Test System or an MTX100B with an Option 7 interface card. Real-time streams can be paused for detailed offline analysis and then when the issue has been found, real-time analysis can be resumed. Real-time monitoring of Video over IP (internet protocol) is also available as a standalone application on a user’s own PC.



## Technical Background

The analyzer has a client-server architecture. Every time the analyzer opens, it starts two processes: `tsca.exe`, which is the client, and `MpegCore.exe`, which is the MPEG analysis engine. Additionally, when the analyzer opens for the first time, another single process, `CoreManager.exe`, is started. `CoreManager.exe` forms an intermediary between TSCA clients and MPEG cores.

The `tsca.exe`, `MpegCore.exe`, and `CoreManager.exe` processes use SNMP (Simple Network Management Protocol) and HTTP (Hypertext Transfer Protocol) to communicate. The port numbers used for communication are read from a configuration file, `CoreInfo.xml`. In a default installation, this file can be found in `c:\program files\tektronix\mpeg\mts400\apps\tsca\xml\`. The default port range is 15700-15800. These values can be changed if they conflict with other applications.

On the MTS400 platform, another process, `mint.exe`, runs from system startup. This process controls shared access to the MTS400 Series hardware by the analyzer and player.

You must have local administrator rights to be able to use IP analysis. If you need to change your rights, please consult your system administrator.

## User Interface

The TSCA software uses a single main program summary window with different context sensitive views contained within tabbed frames. This provides the maximum amount of useful information while keeping the screen from appearing cluttered. From the main window, you can access the following views: Program, Tests, Tables, PID, Packets, and Interface.

### Program View

The Program view provides a fast overview of the transport stream contents in terms of program content, bit rate use by each program, and TR 101 290 test results. Red, amber and green LEDs highlight errors associated with each program, or element of a program, within the transport stream. Red LEDs indicate that there are current errors in the stream, amber LEDs indicate that errors have occurred but are now clear, and green LEDs indicate that no errors have been detected.

Errors that are detected at lower levels in the program stream hierarchy propagate up to the highest level. This allows you to monitor all of the programs in the stream at a high level and then quickly go to lower levels as necessary to locate a problem.

**Tests View** The Tests view enables you to isolate errors to the specific tests that have been applied to the transport stream. The error log is automatically filtered by the selected test, and can also be filtered by Packet Identifier (PID). In addition to the standard first, second, and third priority tests included in TR 101 290 standard, tests are available for Program Clock Reference (PCR) jitter and program/PID bit rate. A variability test enables you to test the changes in the bit rate of a specific PID, and there are many tests that are specific to ISDB-T and ISDB-S streams.

**SI/PSI (Tables) View** The SI/PSI (Tables) view displays the service information tables that have occurred in the analyzed stream which comply with the selected digital video standard. This includes MPEG-specific program information, DVB service information, and ATSC, ISDB program, and system protocol information. The tables are grouped together by function and hyperlinks enable you to quickly access related information within other tables.

**PID View** The PID view displays information about all of the PIDs found in the transport stream. When you select the transport stream, the associated summary view provides a PID-oriented overview of the transport stream, displaying the relative data rates of all of the PIDs contained within the stream. The information can be displayed as either a bar chart or as a pie chart. Pop up menus enable fast limit selection and links.

Each PID is associated with a number of tests. When one or more tests fail, each failed test will be listed under the relevant PID. Select a specific PID to display a summary of all the associated tests. Select a specific test to display the Event Log and Parameters for only that test.

**Packets View** The Packets view displays information about all of the packets found in the transport stream grouped according to content. These groups include PID value, SFN mega-initialization packets (MIPs) (DVB only), and ISDB-T information packets (IIPs). When you select a specific PID or MIP, only packets carrying that particular PID or MIP are displayed. A section view is also available. Deferred analysis of PCAP files allows you to see the ethernet packets.

The Packets view is not available in real-time mode. However, packets in a real-time stream can be examined using the CaptureVu feature.

**Interface View** The Interface view provides a central location for information related to the RF interface card (where installed).

- Test results
- Graphical representation of specific RF card readings
- RF card readings and control settings

The graphical views display a selection of graphs of instantaneous measurements and measurement trends. Also available are an Event Log and a Parameter view.

The Interface tab is displayed only when an interface is installed.

## CaptureVu Feature

The CaptureVu feature captures a snapshot of system events in real and deferred time, and allows you to debug the intermittent and complex problems that traditional analyzers miss. You can initiate CaptureVu either manually or automatically by associating a CaptureVu Breakpoint with any test event. When a breakpoint is detected, either manual or automatic, the stream is paused and an in-depth deferred time analysis can be performed on stored data. This powerful debug mode enables fast debugging of troublesome intermittent problems.

## Triggered Recording

During real-time analysis, stream information can only be held for a finite time - eventually it will be overwritten by more up-to-date information. Triggered recording allows a portion of a stream to be recorded and subsequently analyzed in detail.

The following trigger sources and conditions apply:

- Any test event
- External input; (TTL) edge specifiable
- Date and time
- Recorded file size can be specified
- Pretrigger buffer size can be specified as a percentage of the overall file size range from 0 – 100%

## Starting the TSCA Software

The TSCA can analyze transport streams in either real-time or off-line (deferred) mode.

### Opening the TSCA

From the Windows Desktop, select **Start > Programs > Tektronix MTS400 > Analyzers > TS Compliance Analyzer**.

The TSCA is opened, initially overlaid with the **Open Transport Stream...** dialog box.

Click File Analysis to select the transport stream file to analyze and to select the method for calculating the rate of the stream.

Click Real-time Analysis to select an input source (IP or hardware interface) for real-time analysis.

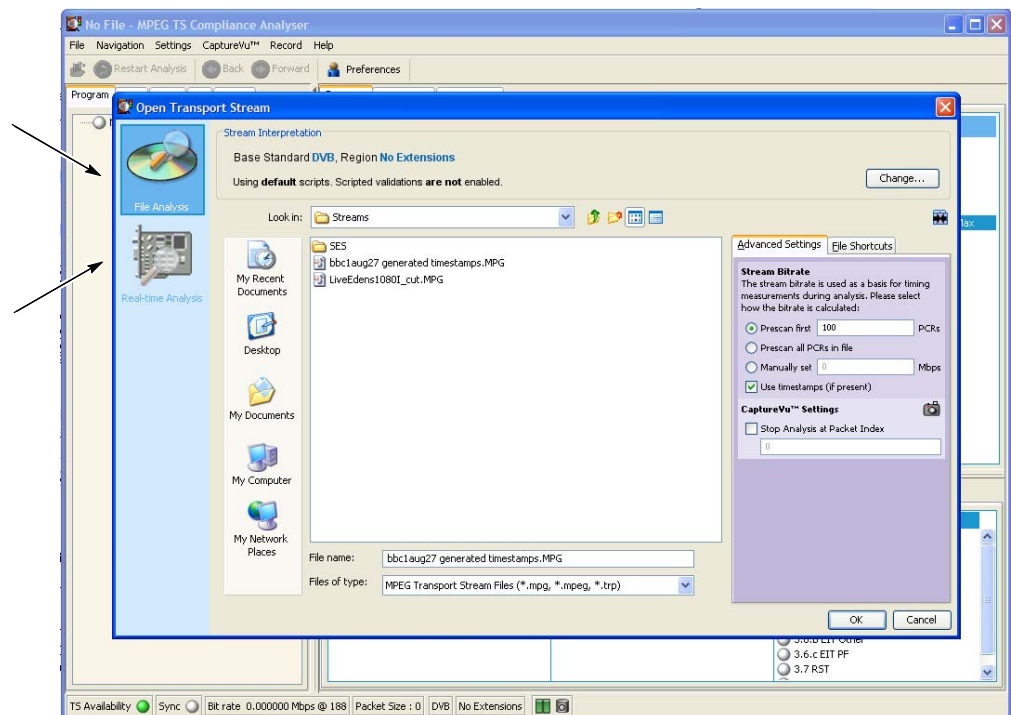

**Figure 2-2: TSCA Start-up**

The **Open Transport Stream...** dialog box allows you to:

- Select the interpretation standard to be used for analysis. (The stream interpretation should be checked and, if necessary, set first.)
- Identify a stream file for deferred analysis. Files can be selected either directly from the disk drive or using previously set up shortcuts.
- Identify an input (IP, ASI or SMPTE or DVB Parallel) receiving a stream and start real-time analysis.

## Interpreting a Stream

You can set up the stream interpretation standard in the following way:

1. Click **Change...** in the Open Transport Stream dialog box to open the Stream Interpretation dialog box.

**NOTE.** The TSCA software analyzes streams in strict accordance with the standards defined by the digital television authorities: DVB (Digital Video Broadcasting), ATSC (Advanced Television Systems Committee), and ISDB (Integrated Services Digital Broadcasting).

The TSCA software uses preloaded scripts which establish the expected content and syntax of the analyzed stream. The analyzer is supplied with a comprehensive range of scripts, which, in different combinations, can interpret the full range of digital television standards.

2. Select the **Base Standards** and then (if available) select the **Region**. The analysis scripts that will be used are displayed in the Script Files pane.

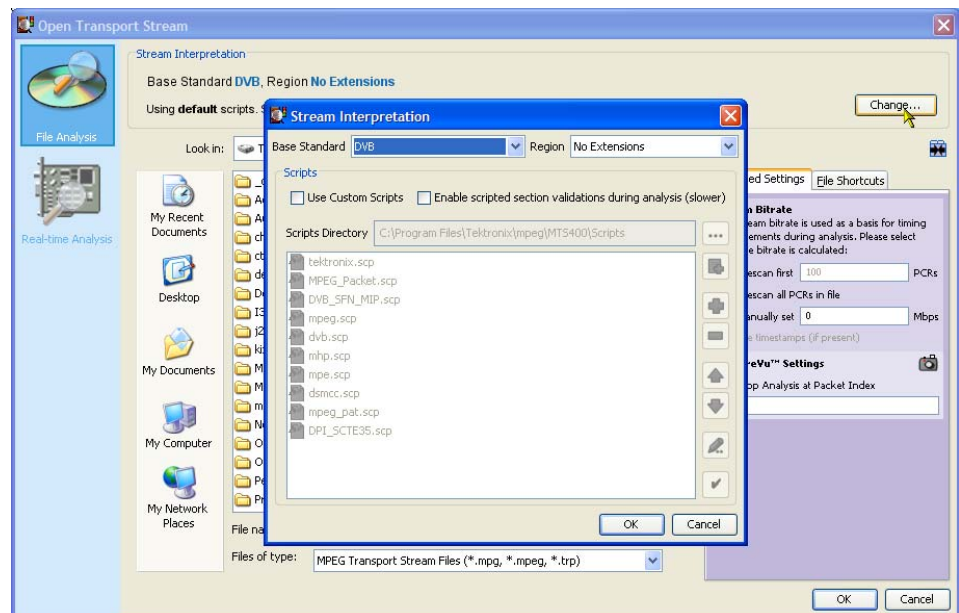

**Figure 2-3: Stream Interpretation dialog box**

3. Select **OK**.

4. The stream interpretation is now set. Choose one of the analysis options to select a file or real-time analysis.

(For details of the Stream Interpretation management, see *Script Files* on page 2–135.)

---

**NOTE.** *The selected stream interpretation standard is not implemented until stream analysis is started. If the Open Transport Stream dialog box is closed without starting analysis, the stream interpretation settings are lost; they revert to the settings that were in effect when the application was last closed.*

---

### **Off-Line (Deferred) Analysis**

Perform the following steps to start analyzing a transport stream file:

1. In the Open Transport Stream dialog box, with File Analysis selected, browse to a transport stream file.

If necessary, select a file type from the Files of type drop-down list. Currently, two types are available: MPEG Transport Stream files and PCAP files.

- MPEG transport stream files contain interlinked tables and coded identifiers, which separate the programs and the elementary streams within the programs.
  - PCAP files contain raw packets of network data. A PCAP may contain more than one session. You will need to select a session using the Browse dialog box.
2. When you select a stream, the stream name appears in the field at the bottom of the window.

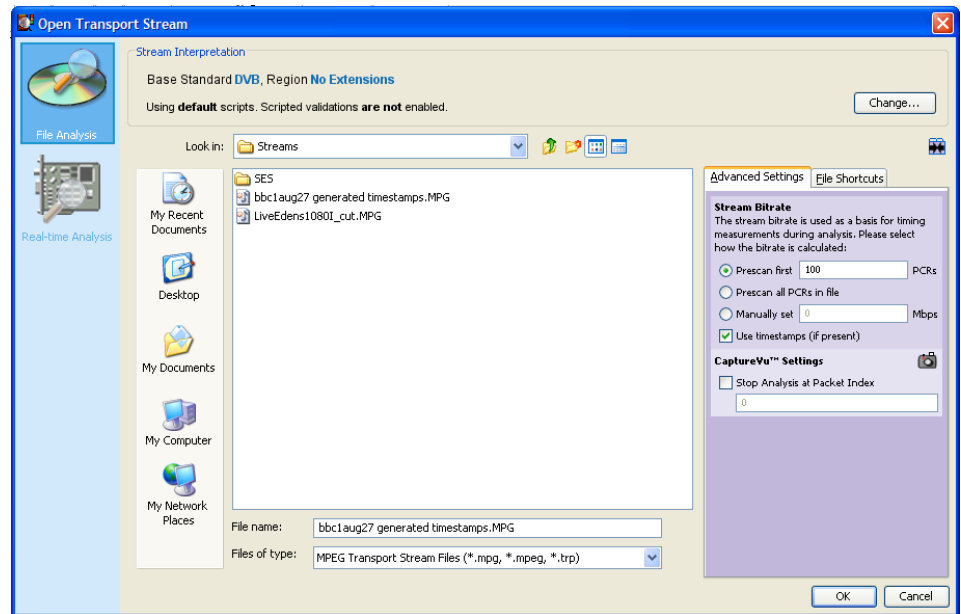

**Figure 2-4: TSCA File Analysis (Offline) dialog box**

3. **Calculating the Transport Rate.** To analyze a transport stream correctly, you must do one of the following:

- Calculate the bit rate from PCRs (Program Clock Reference) carried in the stream

**NOTE.** When the TSCA software analyzes a transport stream, it compares the bit rate of the stream to the expected rate. Errors are reported based on the expected rate of the stream. To analyze a stream correctly, it is necessary to know the original bit rate of the stream or to calculate the bit rate from PCRs (Program Clock Reference) carried in the stream. PCRs are generated as a stable clock reference and are added to the stream during its generation. During analysis, the PCRs are extracted and synchronized with a local clock reference.

- Know the original bit rate and enter it manually
  - Use timestamps included with the stream
4. After you select the desired stream, select one of the following methods for calculating the rate of the transport stream:
- Prescan the first nnn PCRs. When you select this method, the TSCA software calculates the rate of the stream by prescanning the stream for embedded PCRs. The entry box lists the number of PCRs that the TSCA

software recommends are necessary to determine the stream rate. You can use the entry box to enter a different number.

- Prescan all PCRs in a file. When you select this method, the TSCA software calculates the rate of the stream by prescanning the stream for all of the embedded PCRs.
- Manually set nnnn Mbps. When you select this method, the TSCA software uses the absolute value (in Mbps) that you enter as the expected stream rate.

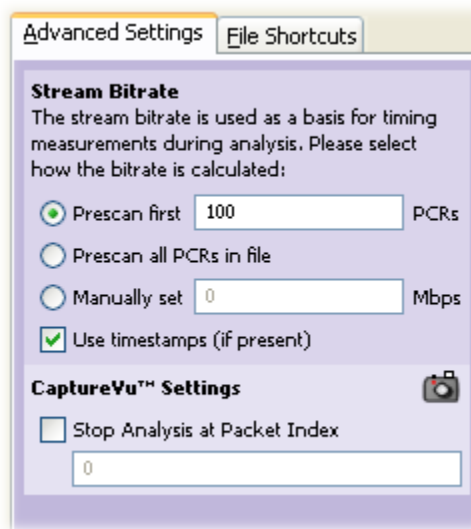

---

**NOTE.** *Timestamps, which are added when the stream is generated, will be used, if present, and if the Use Timestamps checkbox is enabled. Using timestamps will override the PCR options (Prescan PCRs and Scan entire file). The manual bit rate setting will override both PCRs and timestamps.*

---

5. If the TSCA software cannot calculate the bit rate from the embedded PCRs, or timestamps, a message box is displayed. You must enter an estimated bit rate before the TSCA software can analyze the stream.

If the CaptureVu feature is to be used, the whole file can be captured or analysis can be stopped either by a previously set CaptureVu breakpoint or at a specific packet.

6. To stop analysis at a specific packet, enable **Stop Analysis at Packet Index** and enter a packet number.

With a file selected and the transport rate calculation set up, you can start the analysis (see page 2-12).



## Real Time Analysis

Perform the following steps to start analyzing a transport stream received through an IP or a hardware interface.

1. In the Open Transport Stream dialog box, with Real-time Analysis selected, select an interface from the drop-down list.

**NOTE.** For stand-alone installations, only the IP interface is available.

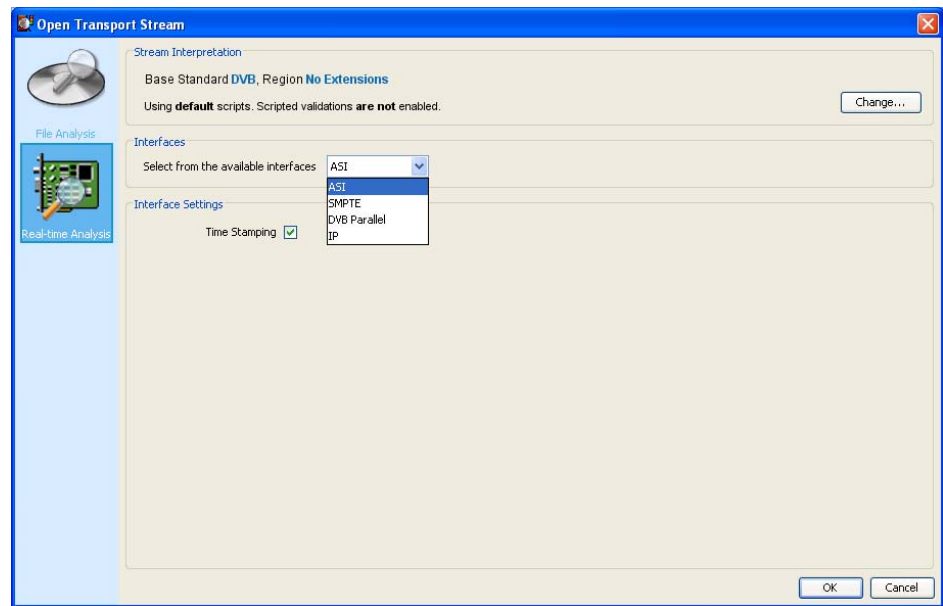

**Figure 2-5: TSCA Real-time Analysis dialog box**

Real-time analysis will not be available if the appropriate software key permissions are not found. A warning message is displayed when real-time analysis is not available.

Make any necessary interface settings. During analysis, the interface selected will be shown in the status bar. (The IP interface settings are described on page 2-13.)

**Start the Analysis**

To start the analysis, follow these steps:

1. After you have selected the interpretation standard and the stream source, click **OK** to continue.

The TSCA software starts analyzing the selected stream. During deferred analysis, a progress bar is displayed. The TSCA starts reporting analysis results (see Figure 2–6).

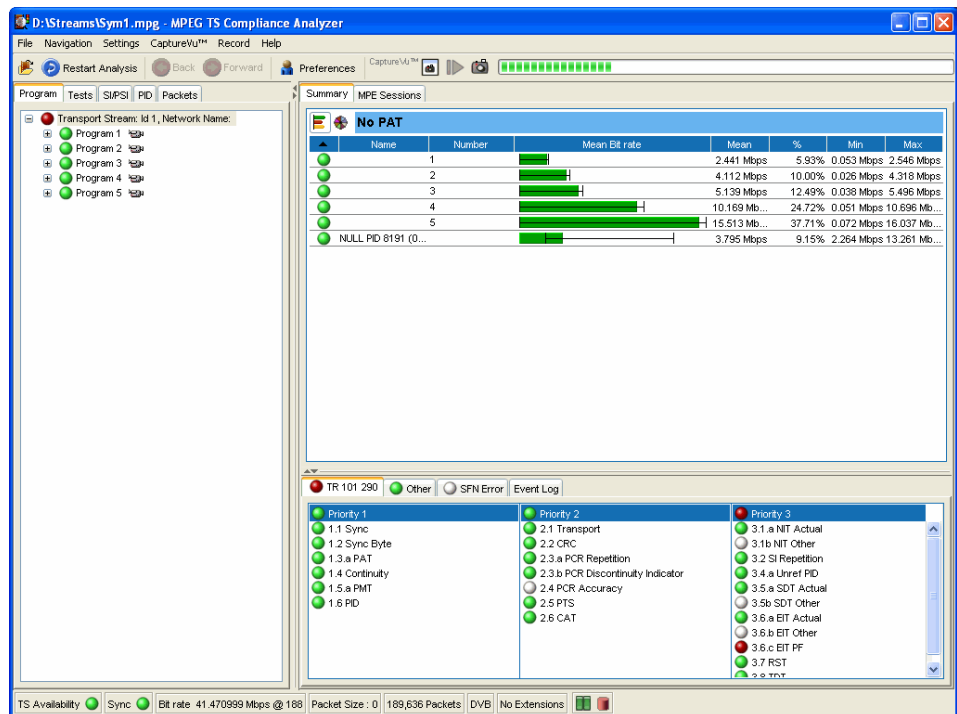

**Figure 2–6: TSCA window showing analysis progress**

2. When sufficient data has been gathered and the display has stabilized, you can start using the TSCA to view the analysis.
3. To analyze another stream file or to reanalyze the current stream using different standards, use the **File > Open Transport Stream** menu selection.

## Setting Up the IP Interface

Two Ethernet interfaces are standard on the MTS400 Series systems (one 10/100 Base T and one 10/100/1000 Base T GigE). A high performance Gigabit Ethernet interface (1000 Base T GigE) can be acquired as an option; this provides accurate hardware timestamping, hardware filtering and a variety of connection options, including copper and optical. These allow for basic detection and display of all UDP (User Datagram Protocol) traffic on a network. Extraction of an MPEG over IP stream is possible (if the licensed option is enabled).

- IP multicast addresses are indicated. Note that the TSCA will not automatically join a multicast group (see *IGMP Group Membership*, page 2–14).
- UDP streams carrying MPEG TS traffic are indicated.
- A selected UDP stream carrying TS traffic may be selected for analysis and recording, in a similar manner to any other physical interface.

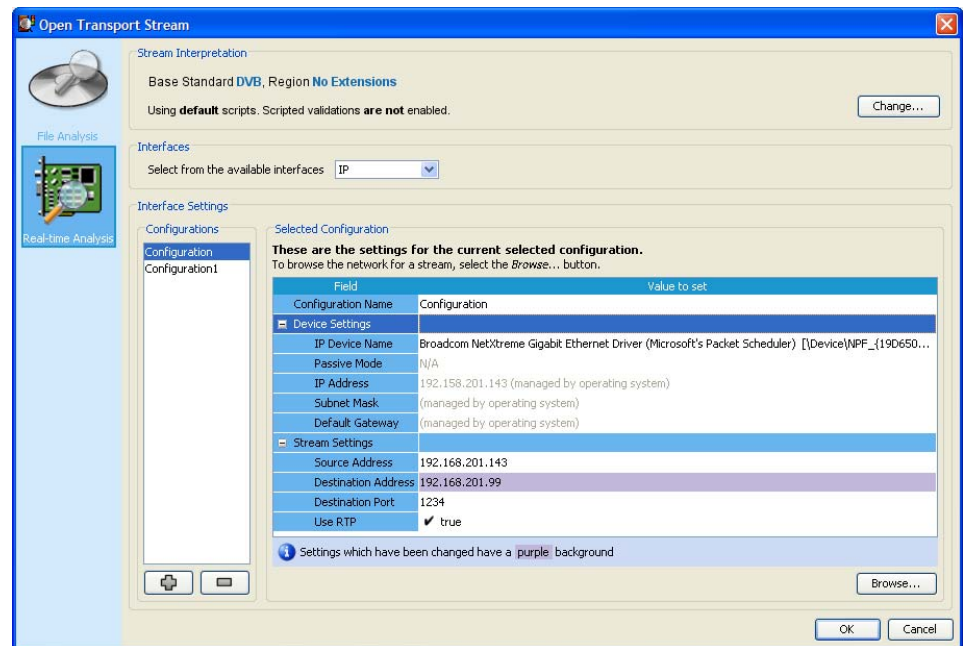

**Figure 2–7: Setting up the IP interface**

In the Open Transport Stream... dialog box with IP selected in the Select Interface drop-down menu, the current settings for the selected configuration are shown. The individual settings are described next.

Select OK to confirm the IP setting and start analysis.

## **Interface Settings Configurations**

You can save individual IP settings configurations to disk; they can be recalled when required. Up to 128 configurations can be specified.

The Open Transport Stream – Real-time Analysis dialog box shows the settings associated with the currently selected configuration.

Different settings can be entered on this screen; the new settings will be used when OK is selected. The new settings can also be saved as a new configuration for future use if required.

**IGMP Group Membership.** Multicast broadcasts can be joined by entering the multicast address in the IGMP Group Membership field in the Browse dialog box. The sessions detected will be listed in the dialog box.

**Create a New IP Configuration.** In the Open Transport Stream – Real-time Analysis dialog box, select the plus button to create a new configuration.

A default configuration name is allocated and displayed in the IP Configuration Name field. You can enter a more meaningful name. New values can be entered as required. This name and the settings associated with it will remain available for recall.

Alternatively, the streams available can be viewed and a new one selected.

Select New to open the Edit IP Configuration dialog box. Select Browse and the Browse for UDP flow... dialog box will be displayed (see Figure 2–8).

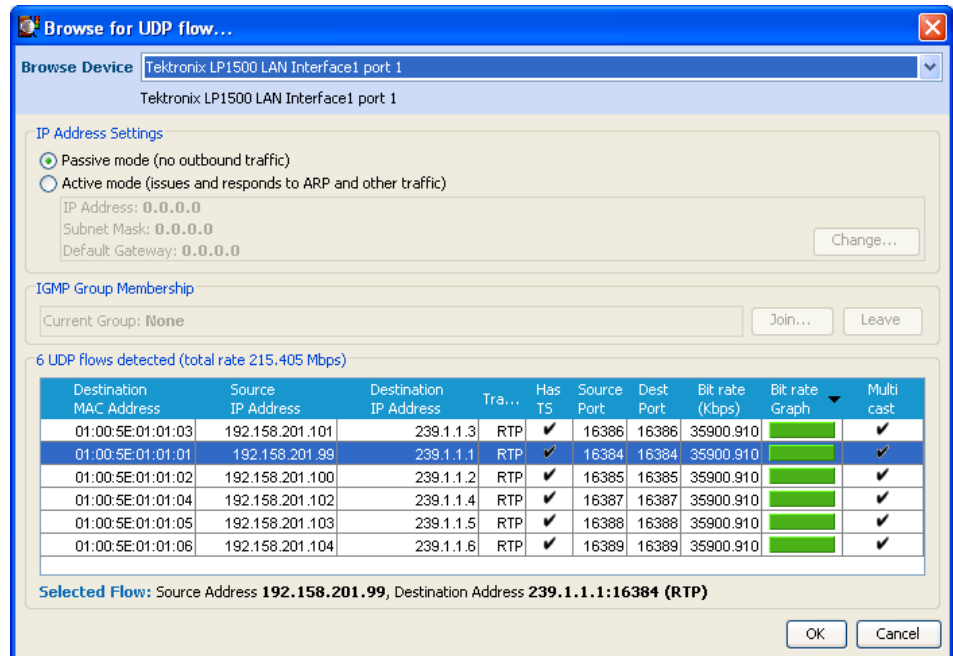

**Figure 2–8: UDP flow selection dialog box**

The names of any network devices installed in the instrument are displayed in the Browse Device field. Select the network device required from the drop-down list. The traffic present on the selected interface is displayed in the bottom half of the dialog box. A summary of the UDP flows detected is displayed in the table header. The bit rates given are UDP bit rates, not transport stream bit rates.

The settings (Source and Destination addresses) can be set up in two ways:

- In the Open Transport Stream, Real-time Analysis, Selected Configuration area, enter data into the Stream Settings fields.

Multicast sessions can be identified by entering the appropriate address in the IP Destination Address field.

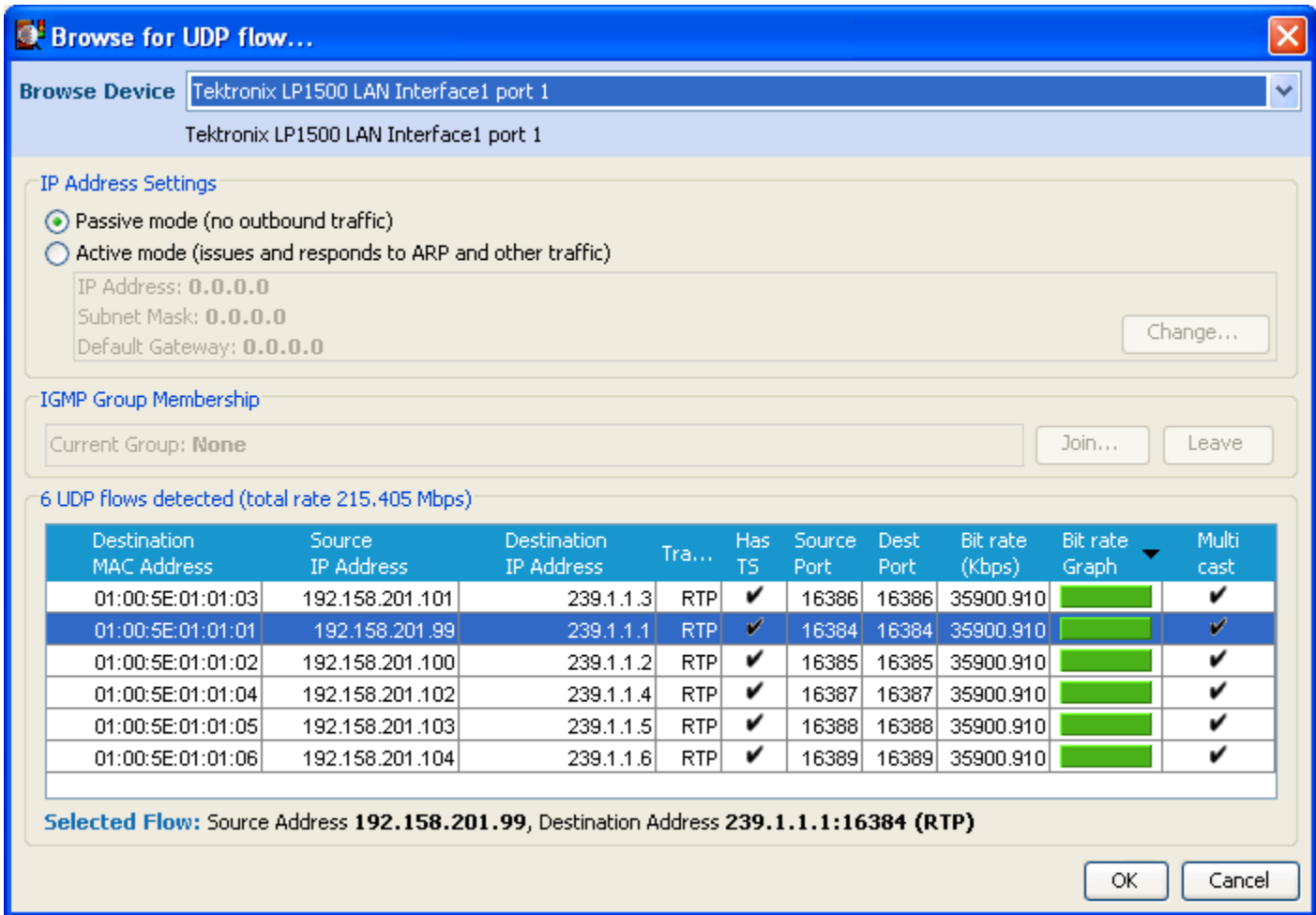

- In the Browse for UDP Flow dialog box, highlight a session in the current traffic area; the values are entered automatically in the Selected Configuration, Stream Settings fields. Traffic carrying transport streams will have a check mark in the Has TS column.

The TSCA should detect whether traffic is transmitted over UDP or RTP; this will be indicated in the Transport column. The Use RTP check box will be updated to match the protocol indicated for the selected session; this setting can be overridden by selecting or clearing the Use RTP setting if it is believed that the protocol indicated is incorrect.

When the settings are correct, select **OK** to confirm and save the configuration. The Edit IP Configuration dialog box closes and the new configuration is immediately available in the Open Transport Stream dialog box.

**Edit an Existing IP Configuration.** An existing IP configuration can be modified as required. Modify the individual fields in the Selected Configuration, Stream Settings fields or select a new entry in the Browse for IP Flow dialog box.

**Select an Alternative IP Connection.** Select a new configuration from the Interface Settings drop-down list. Note the change in the Current Settings section of the window.

**Delete an IP Configuration.** To delete an IP configuration, ensure that the configuration to be deleted is displayed in the Open Transport Stream dialog box and select the minus button. The selected IP configuration is deleted and the next available IP configuration is displayed.

## Setting the Stream Content Font

You can configure the TSCA software to display stream content information in a user-defined font style or language, such as Japanese or Chinese.

**NOTE.** *How the TSCA displays the text strings carried in the stream itself is dictated by the TSCA font setting and by the interpretation standard used during the analysis.*

*How the TSCA displays entries in the Event Log is dictated by the TSCA font setting and fonts used by a local computer. For example, if the default language of the TSCA computer is Japanese, the event log will be displayed in Japanese characters. You must choose a suitable font for the characters to display correctly.*

### Selecting the Display Font

Perform the following steps to set the font that will be used by the TSCA software to display stream content. You can configure the TSCA software to display stream content using any font that is installed on your computer.

1. Select Settings > Preferences... to open the Preferences dialog box.
2. Select Font at the left of the Preferences dialog box to display the window shown in Figure 2–9.

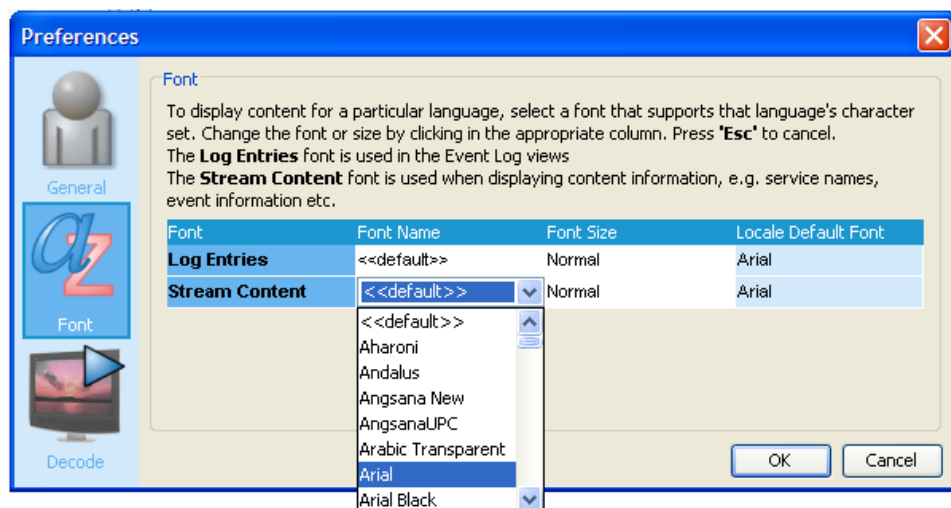

Figure 2–9: Selecting a display font from the Preferences dialog box



3. The dialog box lists the default font used by your computer for the Log Entries and Stream Content displays on the TSCA software. Use the Font Name and Font Size drop-down boxes to select a desired font style and size.
4. Click **OK** to accept and save any changes.

### Installing Asian Language Fonts

Computers that are using local versions of MS Windows 2000 (such as Japanese or Chinese), or MS Windows XP, should have the Asian language fonts already installed on their systems.

If your computer or MPEG test system does not have Asian fonts installed, perform the following steps to install the Asian fonts:

1. Insert the MS Windows OS CD-ROM, which was supplied with your computer or MPEG test system, into the CD-ROM drive.
2. Locate the LangPack directory on the CD-ROM. This directory contains a number of \*.inf files for various languages. For example, you may want to install japanese.inf and tchinese.inf, for Japanese and Traditional Chinese language fonts.
3. To install new fonts, right click on each desired font file in the LangPack directory and select **Install**.
4. The new fonts you installed should now appear as possible font selections in the Preferences dialog box. You must select the new font in the Preferences dialog box before the new font will be used to display stream content.

### Loading a Custom Extension Font

The ARIB specifications for the ISDB standards make use of private extensions to the standard Unicode character set [0xE000-0xF8FF]. These extensions allow you to add additional characters and nonstandard proprietary characters to an existing font. The extension sets are provided as TrueType Extension files (\*.tte). Any extension sets should be installed using the Private Character Editor which is supplied as part of the standard MS Windows installation.

To install a font extension set on your computer:

1. Open the MS Windows Private Character Editor.
  - a. Select **Run** from the Start menu.
  - b. Enter eudcedit in the Run dialog box and click **OK**.
2. After the Private Character Editor opens, close the Select Code dialog box.
3. Select **Font Links...** from the File menu.

4. In the Font Links dialog box, select **Link with Selected Fonts**.

---

**NOTE.** *If you select Link with All Fonts, the following actions will overwrite any existing font extension sets.*

---

5. In the Select Fonts box, find and highlight the font to which you are adding the extension. This font should be the one you selected in the TSCA font preferences dialog box.
6. After you select the font to which you are adding the extension, click on Save As....
7. In the Modify Private Character Filename dialog box, browse to the TrueType extension file you are adding (\*.tte) and click Save.
8. In the Font Links dialog box, click **OK**.
9. Close the Private Character Editor window.
10. To verify that the font extension has been successfully installed, open the Character Map application.
  - a. Select **Run** from the Start menu.
  - b. Enter charmap in the Run dialog box and click **OK**.
11. Browse through the font list for the name of the font to which you added the extension. The term "Private Characters" should follow the font name. When you select the font name in the list, you can view the extended character set.
12. Close the Character Map application.

The new font extension you installed should now appear as a possible font selection in the Preferences dialog box. You must select the new font in the Preferences dialog box before the new font will be used to display stream content.

# Understanding the Analyzer Window

On start up, you can immediately open and analyze a transport stream (see *Starting the TSCA Software* on page 2–6). This will result in a display similar to that shown in Figure 2–10. This is the working display.

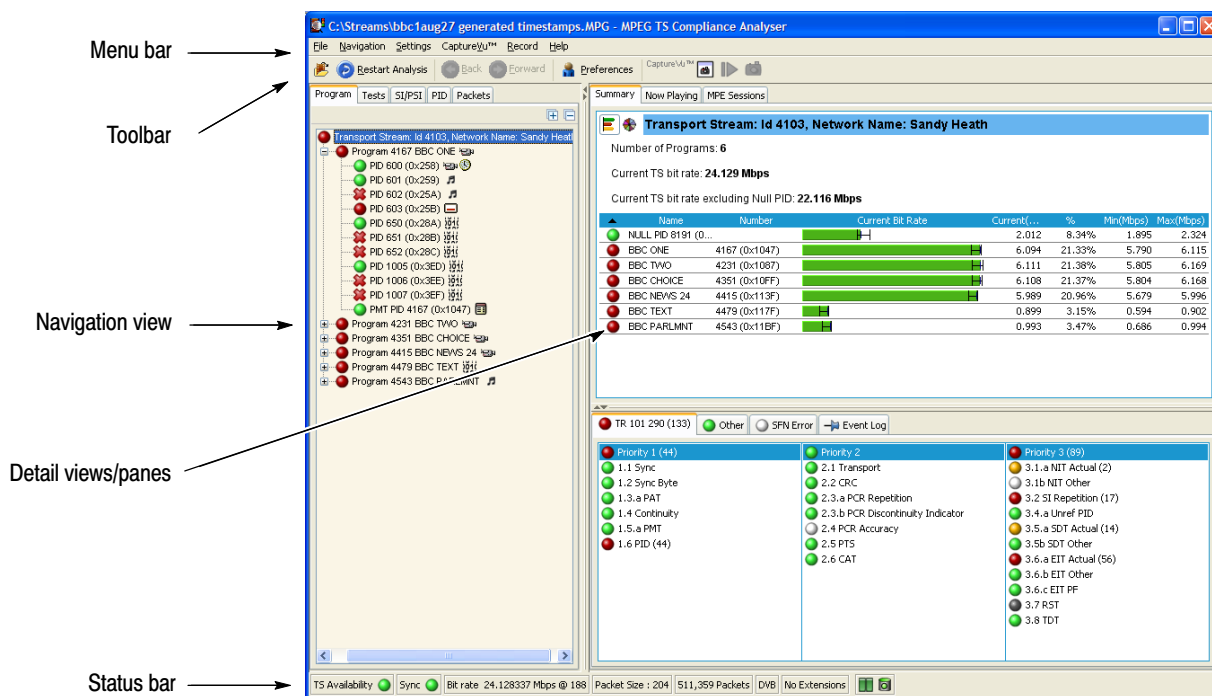

Figure 2–10: Analyzer window









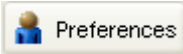

## TSCA Window Components

The TSCA window contains the following components:

**Menu Bar** The Menu Bar provides access to a selection of system options using drop-down menus (see *Menu Bar and Options*, page 2–130).

**Toolbar** The buttons displayed on the toolbar provide shortcuts to often-used menu options. Additional buttons displayed during real-time analysis are shown in Table 2–1:

**Table 2–1: Toolbar icons**

<b>Deferred and Real-time Analysis</b>	
	Opens the Open Transport Stream dialog box.
	Restarts analysis.
	User actions are recorded during a session. The forward and back buttons allow you to step through the actions in order to review or repeat them.
	Opens the Preferences dialog box from which you can set your preferences.
<b>CaptureVu</b>	
	View CaptureVu status.
	Resume file analysis.
	Stop and capture analysis.
<b>Real-time analysis</b>	
	View record setting.
	Arm record feature.
	Start recording.
	Stop recording.

**Progress bar** The progress bar indicates the progress of processing during deferred analysis of a stream.

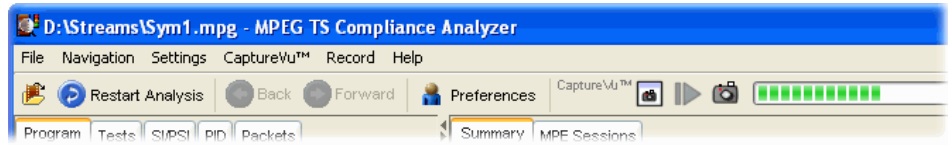

To stop the analysis process, click the Stop button on the toolbar.

**Navigation View** The left side pane in the main window is the navigation view and provides the main analysis information for the transport stream in a number of forms: Programs, Tests, SI/PSI, PID, Packets and Interface. Views are selected using the tabs at the top of the pane. The background of each view is color-coded to aid identification.

**Detail View/Panes(s)** The right side pane in the main window is the detail view and provides details related to the selection made in the current navigation view. The overall view may be subdivided into one or more panes; you can access individual views in multiple pane views using tabs.

**Status Bar** The status bar, when not hidden, is displayed at the bottom of the main window and shows a summary of stream statistics.

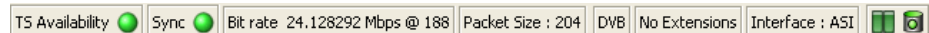

The fields, from left to right, are as follows:

TS Availability	Indicates that either the stream bit rate has fallen below the minimum value or that synchronization has been lost (see also Sync below). The minimum stream bit rate is set using the “Min stream bit rate for processing” parameter, see <i>Parameter Edit</i> , page 2–104.
Sync	Shows the status of the MPEG sync loss test. Loss of sync during analysis of a stream may mean that analysis of the complete stream was not possible.
Bit rate	Total bit rate of the transport stream. The packet value (188 or 204) is set using the Preferences feature (see page 2–133).

Packet Size                      Packets in a stream can be either 188 or 204 bytes long. This is detected automatically.

Stream Interpretation, Base Standard  
 This is the set of tests that is being used to analyze the stream.

Stream Interpretation, Region  
 This subset of tests modifies the base standard; it may add tests or modify existing ones.

Physical Interface              The current interface for real-time analysis.

Partial Reception Availability   
 (Available only for ISDB-T streams.) This icon indicates the presence of partial reception data in the stream. The colors indicate the status as follows:

- Gray:            Partial reception availability is unknown.
- Green:         Partial reception data is available.
- Gray +         Partial reception data is not available.
- red cross:

Processing Throttle Indicator   
 This icon consists of two adjacent LED indicators which show the status of the TSCA processing engine. The left indicator shows the “strained” status; that is whether throttling is being applied to cut down on the information being processed. The right indicator shows the “overwhelmed” status; that is whether the processing engine is able to cope with the amount of information in the stream even after throttling. The colors indicate the status as follows (The general color coding scheme is described in *Error Status LEDs*, see page 2–26):

- Green:         OK
- Amber:         Processing was strained/overwhelmed but is currently OK
- Red:            Processing is currently strained/overwhelmed
- White:         Processor state is unknown
- Gray:           Test disabled

**System Log Status**  Shows the status of the system log which records system-wide events, for example, scripting errors. The color of the LED (in the body of the icon) indicates the most serious event state in the log. When the top surface of the icon is gray, it indicates that all entries in the log have been viewed. Double-click the icon to view the log.

Gray: The log is empty

Amber: There are entries in the log, but none since the log was last viewed

Red: There are new entries in the log

### Analyzer Window – No Stream Available



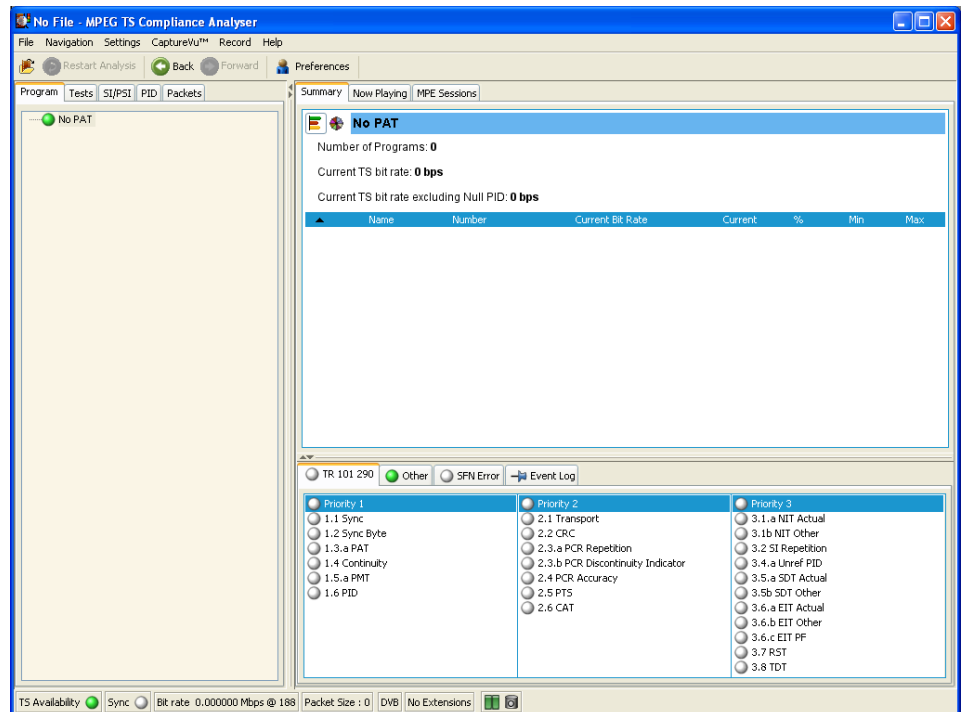





If you choose not to select and analyze a stream, the screen will appear as shown in Figure 2–11. The analysis structure is present, but with no stream content.



**Figure 2–11: Analyzer window - no file**

## Error Status LEDs

A major feature used throughout the TSCA interface is error status LEDs that represent the status of the tests applied to associated items, for example, programs, tests and PIDs. Colors used are as follows:

-  (Red) Error; test failed
-  (Yellow) Transient error (error not currently being detected but has been seen since last reset)
-  (Green) No error; test passed
-  (Dark Blue) Warning (Interface tab only)
-  (Light Blue) Transient warning (warning not current, but has been detected since last reset) (Interface tab only)
-  (Gray): Test disabled
-  (White) Test not applicable or unknown state
-  (Red) PID referenced but not found in the stream
-  (Green) PID referenced but not found in the stream. Applicable test disabled.

When an LED represents a parent node in a tree (for example, a program node is the parent of elementary stream nodes), the color represents the worst case of all of its tests and the worst case of all of the tests represented by its child nodes.

Similarly, when an LED representing a parent node in a tree is disabled or enabled, all subsidiary (or child) nodes are also disabled or enabled to reflect the state of the parent node. When an LED representing a parent node is reset, all the child nodes are also reset.

---

**NOTE.** *The color scheme described here is used throughout the TSCA interface, for example, the bit rate bars in the navigation views.*

---



## Test Management Shortcut Menu Options

Tests can be disabled and enabled as required using the shortcut menu associated with the LED icon. However, it is important to note that the extent of the action depends on the hierarchical level of the icon chosen. For example, choosing Disable from a program node shortcut menu will disable all tests in the program group.

**NOTE.** *In deferred time, if any disabled events are reenabled at the end of analysis, the LEDs will become green. You will have to restart the analysis if you wish to see the status of the test when the test is enabled.*

## Shortcut Menus

Shortcut menus provide an important way of navigating around the TSCA application. They are available on most displayed objects, for example, program tree nodes. These menus provide options relevant to the selected object. For example, after failure, all tests associated with a node can be reset, by selecting the shortcut menu option Reset All Tests. The shortcut menu options provide both actions (for example, enable and disable a function) and quick links to associated objects in other views.

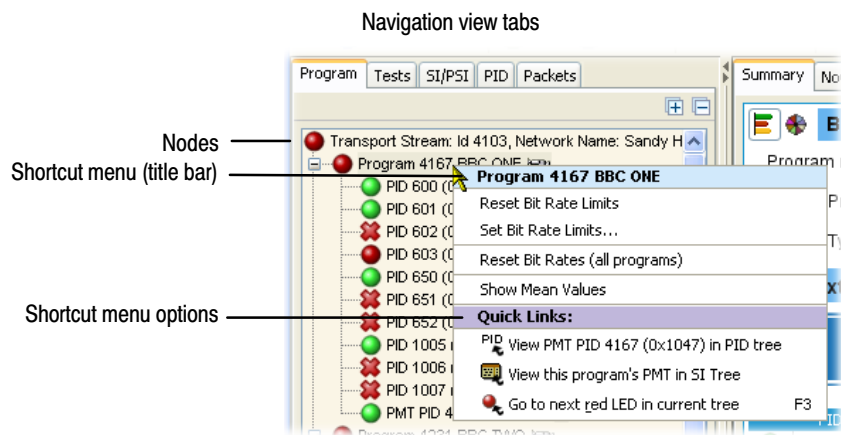

**Figure 2-12: Shortcut menu (example)**

To view shortcut menus, right-click an object. The menus are associated with node types (for example, a PID node). Note that node types can be displayed in more than one view; for example, PID nodes are displayed in the Program view and the PID view. All shortcut menus have a title bar that indicates the node selected.



# Using the Program View

The Program view is displayed when the Program tab is selected in the navigation tabbed pane. The navigation view initially displays the top node of the program tree, which represents the analyzed transport stream from a program perspective.

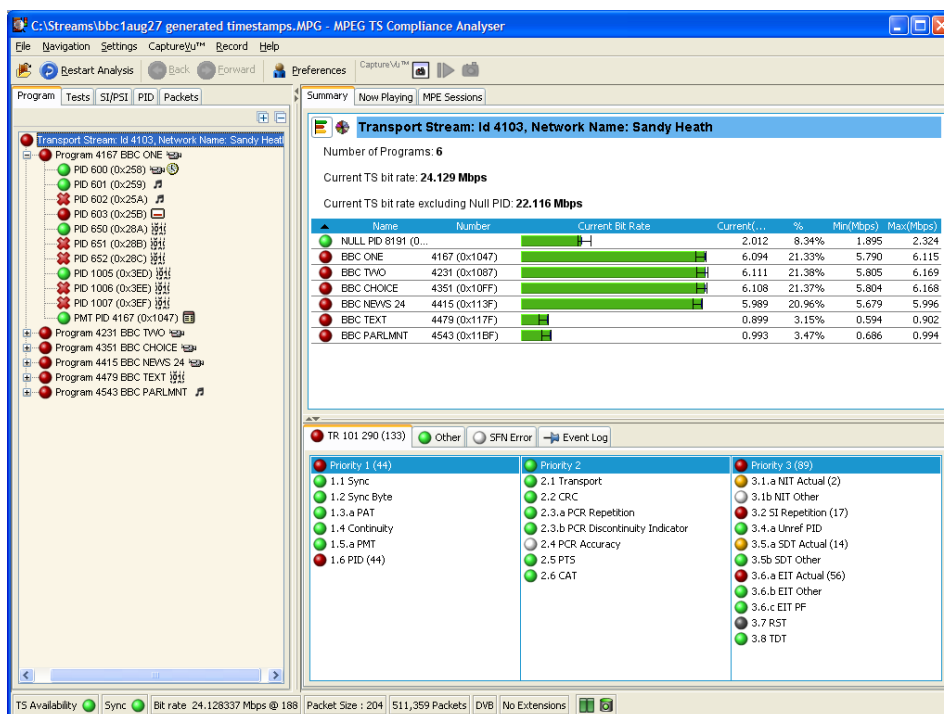

Figure 2-13: Program view

The detail view shows details of the node highlighted in the navigation view.

With the tree expanded, the navigation view shows the makeup of the stream as shown in Figure 2-13; the stream display consists of the nodes shown in Figure 2-14.

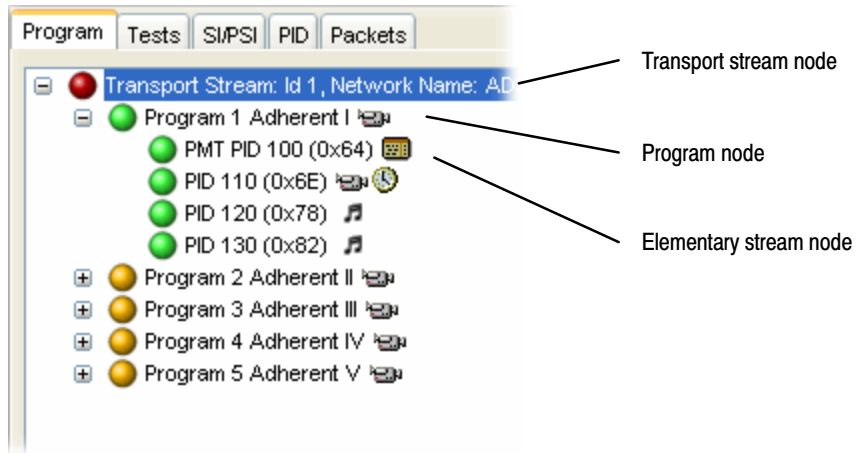

Figure 2-14: Program view nodes

Table 2-2 shows which information is available for each node.

Table 2-2: Program view tabs

Tabs / Node	Summary	Now Playing	IP Graphs	MPE Sessions	Summary / Associated Tests	Graph - Bit Rate	Graph - Timing	Event Log	Parameters
Transport Stream	✓	✓	✓	✓	✓	-	-	✓	-
Program	✓	✓	-	-	✓	✓	-	✓	✓
Elementary Stream	-	-	-	-	✓	✓	✓	✓	✓

In DVB analysis mode, the MPE tab is always present. However, the MPE view will be populated only when MPE data is present in the stream (see page 2-119).

Pressing the F3 key on the keyboard (or selecting **Go to the next red LED in current tree** from one of the shortcut menus) will highlight the next red LED in the current view. Only the lowest level nodes will be considered and highlighted in the search since the parent nodes simply reflect the state of the lowest level nodes.

## Program Navigation - Transport Stream Node

The transport stream node represents the entire transport stream in terms of the programs that it contains. The adjacent LED icon represents the status of the entire transport stream; any status error in the stream will be represented by this LED. When this node is selected, the detail view displays the transport stream summary.

The associated detail view provides a program-orientated overview of the transport stream, allowing you to see the relative data rates of all of the programs contained within the transport. A summary of the overall stream is also displayed. The information can be displayed as either a bar chart or as a pie chart.

The screenshot displays the ASI - MPEG TS Compliance Analyzer interface. The main window shows a tree view of the transport stream 'Id 4103, Network Name: Sandy Heath'. The tree includes programs like BBC ONE, BBC TWO, and BBC THREE, along with various PIDs and PMT. The right pane shows a summary for the selected transport stream, including the number of programs (6), current TS bit rate (40.670 Mbps), and current TS bit rate excluding Null PID (38.684 Mbps). Below this is a table of programs with columns for Name, Number, Current Bit Rate, Current %, Min, and Max. The bottom pane shows an event log with columns for Status, Date, Time, Packet, and Description, listing various TR 101 290 errors and SDT timer errors.

Name	Number	Current Bit Rate	Current %	Min	Max
NULL PID 8191 ...		1.985 M...	8.23%	0.000 M...	12.061 ...
BBC ONE	4167	6.096 M...	21.35%	0.504 M...	6.117 M...
BBC TWO	4231	6.109 M...	21.40%	0.508 M...	6.172 M...
BBC THREE	4324	6.100 M...	21.40%	0.510 M...	6.166 M...

The data rate of a program is the cumulative data rate of all the PIDs that are associated with that particular program, including PCR and ECM PIDs.

**NOTE.** Components can be shared between programs, so the overall data rate of all of the programs may appear to be greater than the total data rate of the transport stream as shown in the status bar.

**Bar Chart** You can display the transport stream bar chart by selecting the bar chart icon.

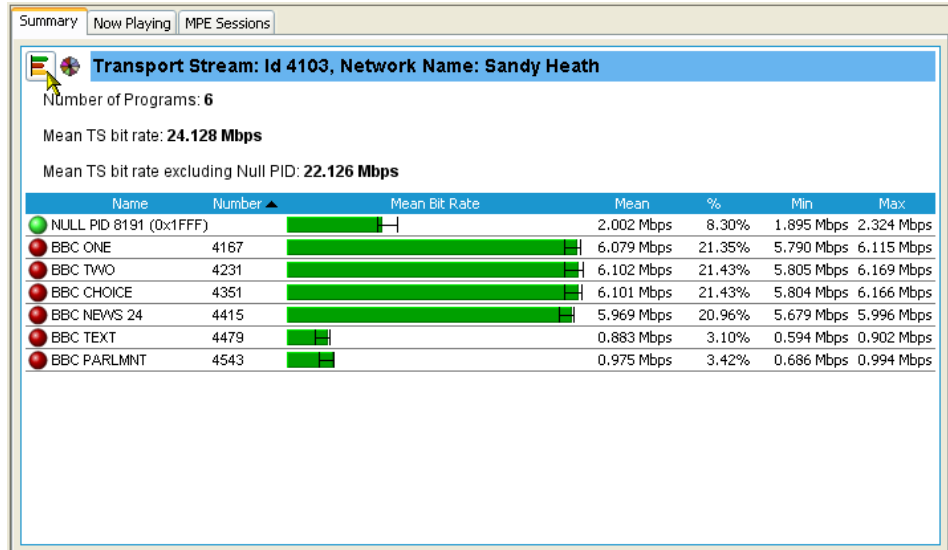

Each program identified in the stream is allocated one row of the table. Related information includes the overall program status (icon), the program name, program number, and the maximum, minimum and average bit rates.

In addition to the basic display, you can associate a maximum and minimum threshold value with each program in the bar chart (see page 2–111). For deferred analysis, where these values are set after analysis, the stream must be reanalyzed for the new values to be applied. In real-time analysis, the new values will take effect immediately. The color of the bit rate bar indicates that the program has stayed within the bit rate limits (green) or exceeded the limits (red).

**Pie Chart** You can display the transport stream pie chart by selecting the pie chart icon.

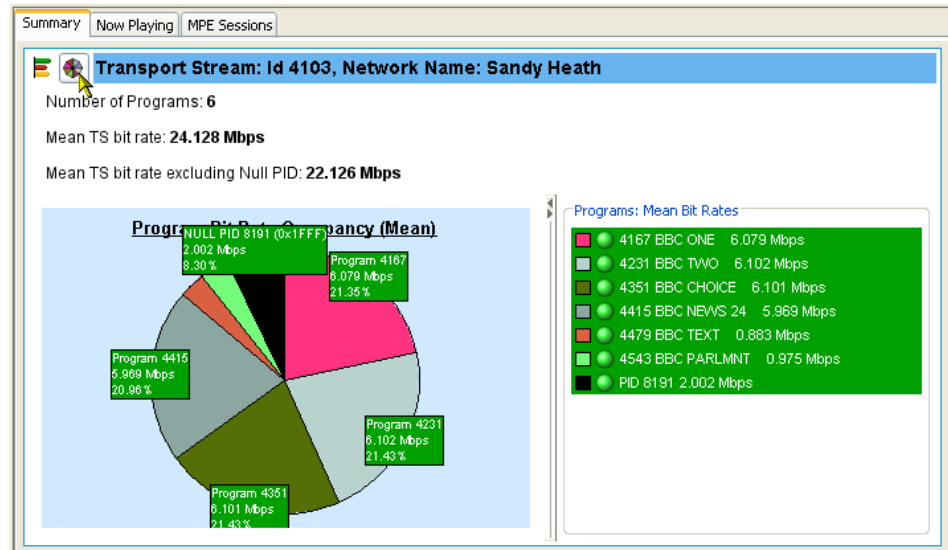

The pie chart view is divided into two panes. The left pane shows the pie chart, and the legend on the right provides a list of the component programs. Each program is color-coded. Related information given includes the overall program status (icon), the program name and number, and the bit rate. The values given in the pie chart labels are bit rates expressed as percentages of the overall bit rate. The Null PID is shown in this view.

The color of the bit rate labels (and the bit rate values in the legend) reflects the status of the bit rate measurement, for example, green indicates that the program has stayed within the bit rate limits, and red indicates that the bit rate has exceeded the limits.

### Bit Rate Value Display

You can toggle the bit rate displays between the mean bit rate and the current bit rate by selecting or clearing the **Show Mean Values** option on the detail view shortcut menus (see Figure 2–15). A check mark adjacent to the option indicates that mean values are to be displayed.

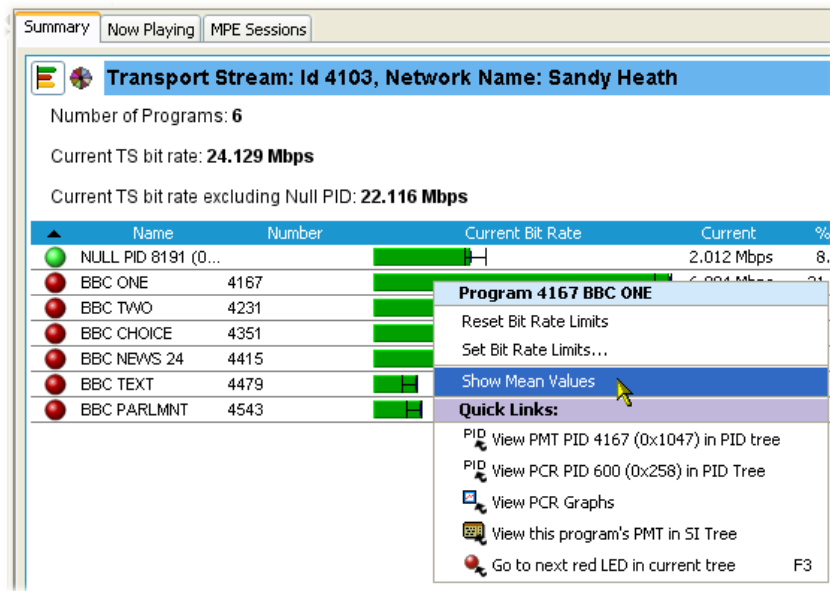

Figure 2–15: Bit rate values display

**NOTE.** The bit rate value shown in the Status Bar is always the mean bit rate. It is unaffected by the mean/current selection.

### Test Status Panes

The lower view pane allows you to see a summary of the states of all the associated tests as well as the event log for the entire transport stream (an unfiltered event log). The test tabs available will depend on the interpretation standard chosen. For example, with the DVB interpretation standard, the available tabs are TR 101 209 and Other. Other interpretation standards will generate different tabs and different sets of tests (see *SI/PSI Nodes*, page 2–157). When any test in the transport stream has failed (and has not been reset), you can identify which individual tests have failed by observing the red LEDs.

You can use the shortcut menus to reset and disable tests, to set alarms, CaptureVu Breakpoints and record flags, and to jump to associated tests.



## Event Log

The Event Log (Figure 2–16) displays the log entries for the whole transport stream. In deferred mode, the packet generating the error report can be inspected by highlighting the error and selecting **Go to packet** from the shortcut menu. Similarly, in real-time analysis mode, and where an event concerns a PID carrying a PCR, you can use the shortcut menu to jump to the relevant PCR graph. Deferred PCAP file analysis enables a shortcut that allows Ethernet packets to be viewed.

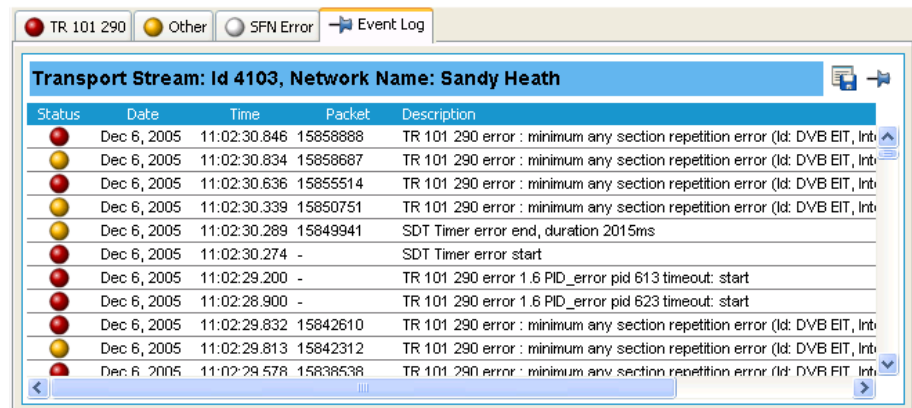

Status	Date	Time	Packet	Description
●	Dec 6, 2005	11:02:30.846	15858888	TR 101 290 error : minimum any section repetition error (Id: DVB EIT, Int
●	Dec 6, 2005	11:02:30.834	15858687	TR 101 290 error : minimum any section repetition error (Id: DVB EIT, Int
●	Dec 6, 2005	11:02:30.636	15855514	TR 101 290 error : minimum any section repetition error (Id: DVB EIT, Int
●	Dec 6, 2005	11:02:30.339	15850751	TR 101 290 error : minimum any section repetition error (Id: DVB EIT, Int
●	Dec 6, 2005	11:02:30.289	15849941	SDT Timer error end, duration 2015ms
●	Dec 6, 2005	11:02:30.274	-	SDT Timer error start
●	Dec 6, 2005	11:02:29.200	-	TR 101 290 error 1.6 PID_error pid 613 timeout: start
●	Dec 6, 2005	11:02:28.900	-	TR 101 290 error 1.6 PID_error pid 623 timeout: start
●	Dec 6, 2005	11:02:29.832	15842610	TR 101 290 error : minimum any section repetition error (Id: DVB EIT, Int
●	Dec 6, 2005	11:02:29.813	15842312	TR 101 290 error : minimum any section repetition error (Id: DVB EIT, Int
●	Dec 6, 2005	11:02:29.578	15838538	TR 101 290 error : minimum any section repetition error (Id: DVB EIT, Int

**Figure 2–16: Event log**

Two buttons are available in the Error Log toolbar:



Pin log / Log is Pinned.



Export Log.

The buttons are described in detail in *Event Log*, page 2–107.

## IP Graphs

The IP graphs available are as follows:

- **Packet Interarrival Time (PIT):**  
Shows the mean interarrival time of IP packets.
- **PIT histogram:**  
Shows the distribution of packet arrival intervals. The X axis contains accumulators where interval times are collected. The Y axis corresponds to number of intervals that collect in each accumulator.
- **Ethernet flow rate:**  
Bit rate of the Ethernet flow being analyzed.
- **Delay factor:**  
A measurement which characterizes IP packet cumulative jitter and delay. (Delay factor is the amount of buffer, in milliseconds, that would be required to subtract IP packet arrival deviations from the rate determined by the media payload.)
- **Media loss rate:**  
Media packets lost per second.

The graphs actually available are dependent upon the IP interface options being used. Unavailable graph names will be grayed out in the selection menu.

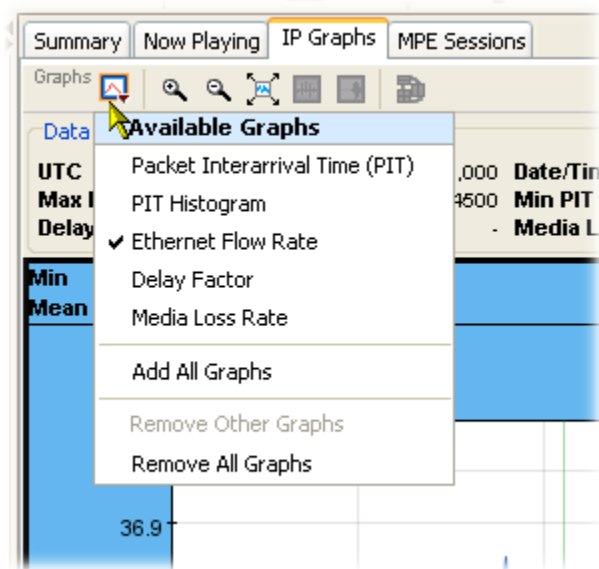

---

**NOTE.** Graph management and timing graphs are described in more detail in the *Common User Interface Concepts* section of this manual (see page 2–85).

---

## Program Navigation - Program Nodes

Each of the program nodes in the transport stream represents a single program referenced within the stream. When a program node is selected in the navigation view, the detail pane displays the details of the program. The LED adjacent to the program node represents the status of its child nodes (elementary streams) and the related tests.

The screenshot displays the MPEG TS Compliance Analyser interface. The left pane shows a tree view of program nodes for Transport Stream Id 4103. The selected node is Program 4167 BBC ONE. The right pane shows the details for this program, including its number (4167), service provider (BBC), and service type (digital television service). A 'Now/Next' section shows 'The Sound Of Music' at 13:25 - 16:10 UTC and 'BBC News' at 16:10 - 16:25 UTC. Below this is a table of associated elementary streams.

PID	Stream type	Mean Bit Rate	Mean %	Min	Max	Component ...
600 (0x258)	2 (0x02) (MPEG-2 Video)	4926.378 kbps	80.80%	4918.080 Kbps	4934.624 Kbps	1 (0x1)
601 (0x259)	3 (0x03) (MPEG-1 Audio)	268.576 kbps	4.41%	266.208 Kbps	270.720 Kbps	2 (0x2)
602 (0x25A)	3 (0x03) (MPEG-1 Audio)	0.000 kbps	0	0.000 Kbps	0.000 Kbps	6 (0x6)
603 (0x25B)	6 (0x06) (PES private d...)	0.943 kbps	<0.0...	0.000 Kbps	18.048 Kbps	5 (0x5)
650 (0x28A)	11 (0x0B) (DSM-CC U-N ...)	833.283 kbps	13.67%	544.448 Kbps	851.264 Kbps	101 (0x65)
651 (0x28B)	11 (0x0B) (DSM-CC U-N ...)	0.000 kbps	0	0.000 Kbps	0.000 Kbps	102 (0x66)
652 (0x28C)	11 (0x0B) (DSM-CC U-N ...)	0.000 kbps	0	0.000 Kbps	0.000 Kbps	103 (0x67)
1005 (0x3ED)	11 (0x0B) (DSM-CC U-N ...)	50.015 kbps	<0.0...	49.632 Kbps	51.136 Kbps	110 (0x6E)
1006 (0x3EE)	11 (0x0B) (DSM-CC U-N ...)	0.000 kbps	0	0.000 Kbps	0.000 Kbps	111 (0x6F)
1007 (0x3EF)	11 (0x0B) (DSM-CC U-N ...)	0.000 kbps	0	0.000 Kbps	0.000 Kbps	112 (0x70)
4167 (0x10...)	PMT	17.694 kbps	<0.0...	15.040 Kbps	18.048 Kbps	

The program detail view provides you with an overview of the selected program, allowing you to see the relative data rates and stream types of all of the PIDs that are associated with the program (including PCR and ECM PIDs). If the program contains an MPEG2 or H.264 video stream, it is decoded to produce a thumbnail picture of the content; this is updated during real time analysis. Similarly, where EPG information is associated with the program, a summary (Now and Next program) is displayed. PID content is indicated using icons, which are described on page 2–87. Bar chart and pie chart views are available.

PID related information is available under the Summary tab.

The Now Playing tab displays details of the streams and thumbnails for each of the programs (where available). (See also *Now Playing Views*, page 2–102).

The Associated Test tab shows tests related to the program. Similarly, the Bit rate Graphs tab displays the program bit rate in graph form.

The Parameters view displays the parameters associated with the currently selected test in the Associated Tests pane (if applicable). You can change the parameter values, as well as display the current, minimum and maximum values for each of the test parameters. For deferred analysis, where these values are set after analysis, the stream must be reanalyzed for the new value to be applied. In real-time analysis, the new values will take effect immediately.

The Event Log shows the errors for the highlighted test. When no tests are selected, the event log will show the events related to all tests associated with the elementary stream selected in the program tree.

### VLC Media Player

The VLC Media Player is a portable multimedia player for various audio and video formats. The player allows program content displayed in the TSCA thumbnails to be played in a larger window. The media player is automatically accessed from the TSCA when you want to view or listen to the video and audio content of program streams.

---

**NOTE.** *The VLC Media Player is not installed as part of the MTS400 Series system. Installation of the player is described in the MTS400 Series Getting Started manual (Tektronix part number: 071-1505-xx).*

*You can find full documentation of VLC on the <http://www.videolan.com>.*

---

To start the media player, click the start button (below the thumbnail) in the Program Summary view.



The VLC Media Player is opened automatically and the selected program content (video and/or audio) will be played. You can close the player by clicking the stop button (below the thumbnail). The player will close automatically.

**NOTE.** The VLC Media Player may open “behind” the TSCA window. Use the Windows controls to bring it forward.

**NOTE.** If the VLC Media Player is installed on the MTX100B instrument, the audio feature in the media player must be disabled. Refer to the MTS400 Series Getting Started manual (Tektronix part number: 071-1505-xx).

## Program Navigation - Elementary Stream Node

Each of the elementary stream nodes in the program tree represents a single elementary stream referenced by the parent program. When this node is selected, the view pane displays the Elementary Stream summary view.

The screenshot shows the MPEGS Compliance Analyser interface. The left pane displays a tree view of the program structure, including 'Transport Stream: id 4103, Network Name: Sandy H' and several programs like 'Program 4167 BBC ONE'. The main pane shows the 'PID 603 (0x25B) Stream type: 6 (0x06) (PES private data), Current Bit Rate: 0 bps'. Below this, the 'Event Log' table is visible, showing a list of errors:

Status	Time	Packet	Description
●	00:00:31.696	-	TR 101 290 error 1.6 PID_error pid 603 [0x25b] timeout: start
●	00:00:30.608	491043	TR 101 290 error 1.6 PID_error pid 603 [0x25b] timeout: end, duration 3908ms
●	00:00:27.696	-	TR 101 290 error 1.6 PID_error pid 603 [0x25b] timeout: start
●	00:00:26.607	426886	TR 101 290 error 1.6 PID_error pid 603 [0x25b] timeout: end, duration 3908ms
●	00:00:23.699	-	TR 101 290 error 1.6 PID_error pid 603 [0x25b] timeout: start
●	00:00:22.608	362696	TR 101 290 error 1.6 PID_error pid 603 [0x25b] timeout: end, duration 3908ms
●	00:00:19.698	-	TR 101 290 error 1.6 PID_error pid 603 [0x25b] timeout: start
●	00:00:18.658	299336	TR 101 290 error 1.6 PID_error pid 603 [0x25b] timeout: end, duration 2059ms
●	00:00:17.598	-	TR 101 290 error 1.6 PID_error pid 603 [0x25b] timeout: start
●	00:00:16.368	262594	TR 101 290 error 1.6 PID_error pid 603 [0x25b] timeout: end, duration 2068ms
●	00:00:15.299	-	TR 101 290 error 1.6 PID_error pid 603 [0x25b] timeout: start
●	00:00:14.208	227942	TR 101 290 error 1.6 PID_error pid 603 [0x25b] timeout: end, duration 3908ms

In addition, when the cursor hovers over the elementary stream node, a tooltip is displayed giving stream type and description.

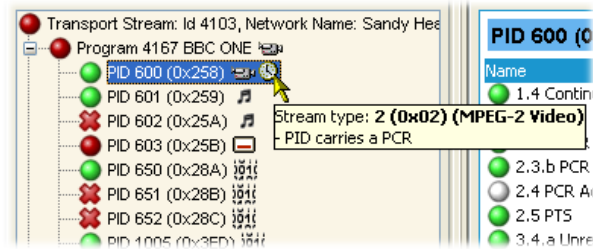

An LED associated with each elementary stream node indicates the status of the tests relating to the elementary stream.

When the selected elementary stream PID contains timing information, PCR trend analysis views are also available, allowing you to display graphs of PCR accuracy and PCR interval data. When the transport stream contains timestamped data, the PCR overall jitter, PCR frequency offset, PCR arrival time, and PCR drift rate graphs are also available.

**NOTE.** Graph management and timing graphs are described in more detail in the Common User Interface Concepts section of this manual (see page 2–85).

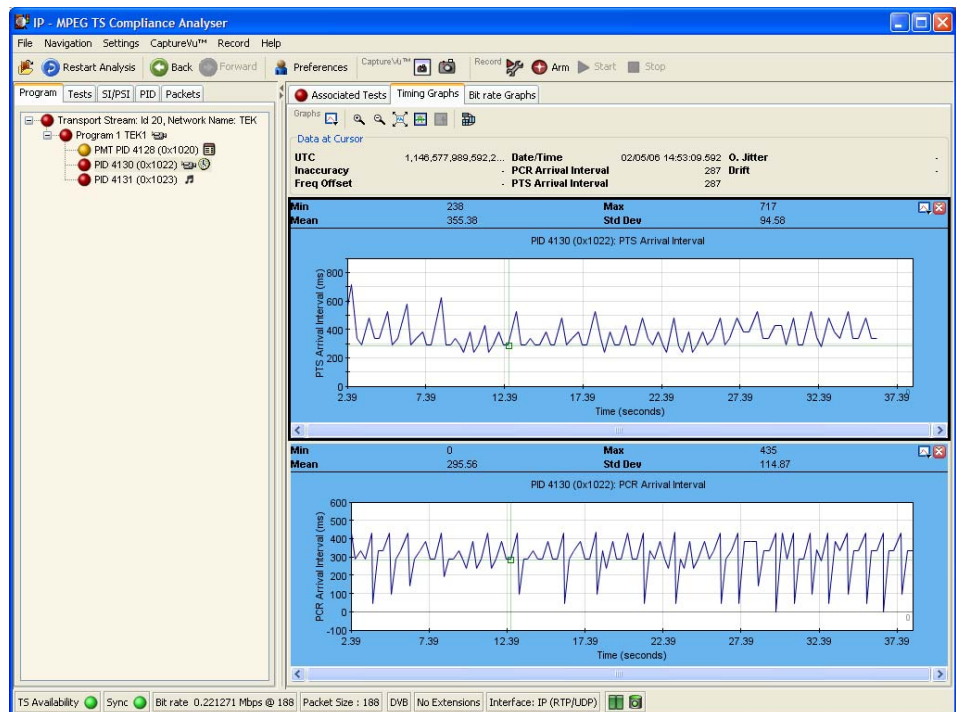

Figure 2–17: PCR Graphs view

The Associated Tests tab shows tests related to the elementary stream node.

The Parameters view displays all of the parameters for the currently selected test in the Associated Tests pane (if applicable). As well as displaying the current, minimum and maximum values for each of the test parameters, you can change the parameter value. For deferred analysis, when values are changed, the stream must be reanalyzed for the new values to be applied. In real time, the changes will take effect immediately.

Similarly, the Event Log shows the errors for the highlighted test. When no tests are selected, the event log will show the events related to all tests associated with the elementary stream selected in the program tree.





# Using the Tests View

The Tests view displays test information relevant to the transport stream being analyzed. The view is displayed when the Tests tab is selected in the Navigation tabbed pane (see Figure 2–18).

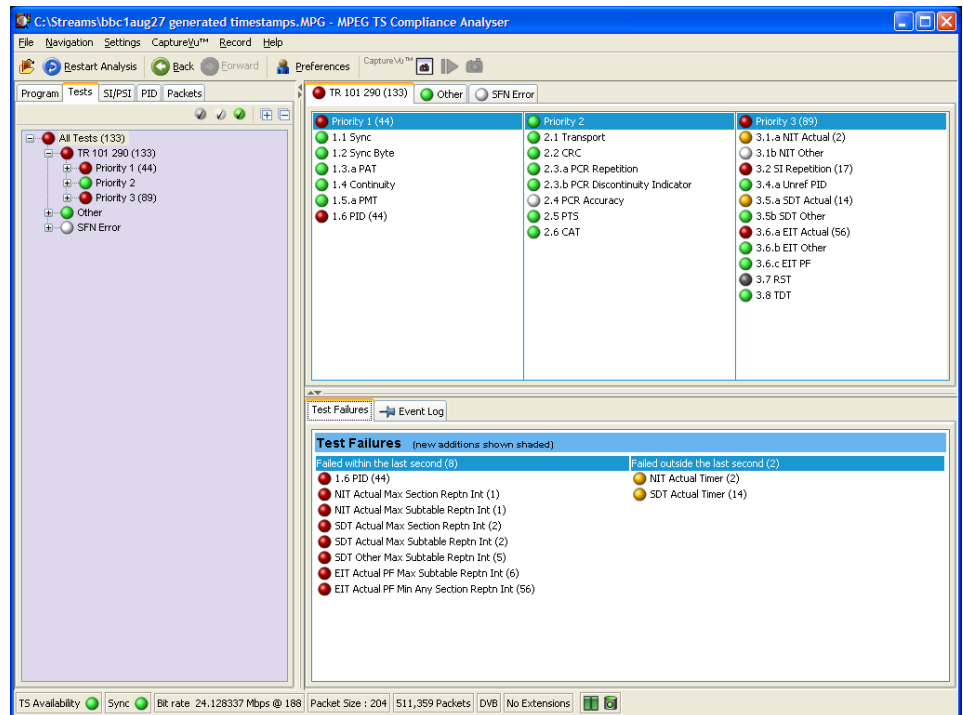

**Figure 2–18: Tests Navigation view**

The view displays a test tree which represents all the tests that have been applied to the analyzed transport stream. Figure 2–19 shows the nodes available in the navigation view.

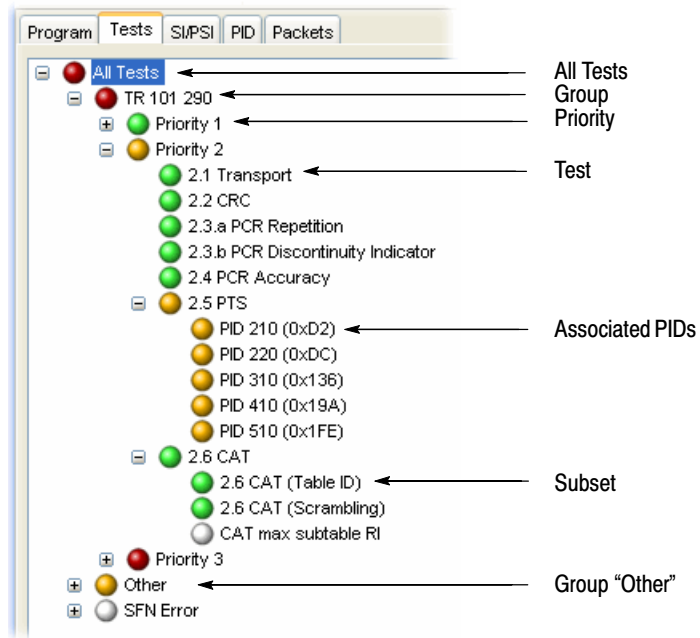
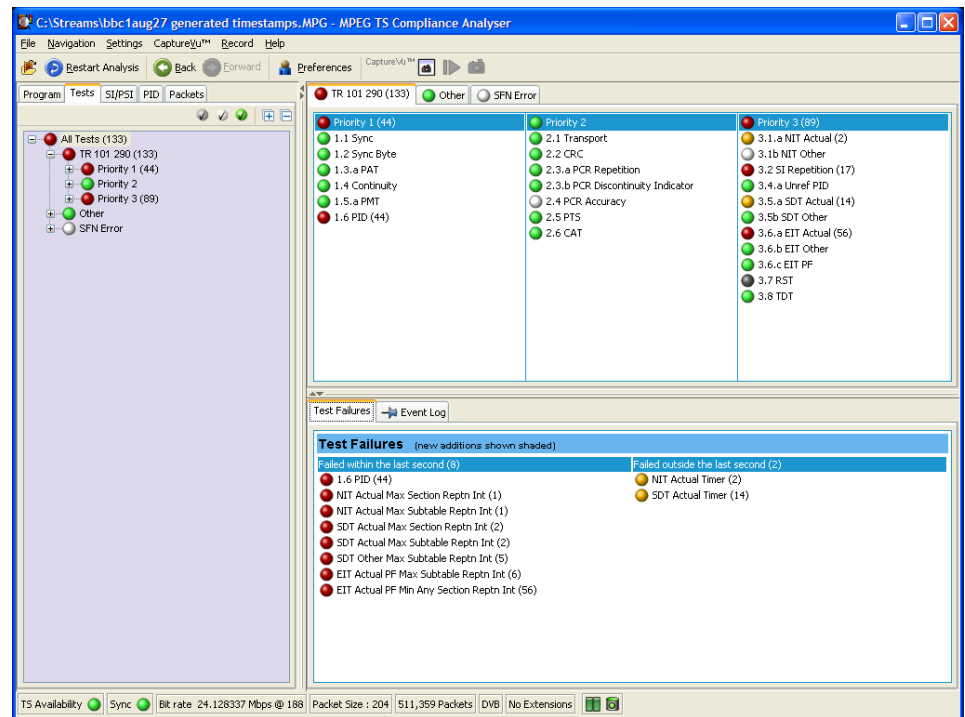

Figure 2-19: Test view nodes

## Test Structure

The test tree structure represents all of the tests that can be applied to a transport stream complying with a particular digital video standard: MPEG, DVB, ATSC, ISDB-S, and ISDB-T. The standard must be selected before beginning analysis. The test tree contains nodes for each test that the analyzer can implement.

An example of a tree structure for a selected standard is the TR 101 290 group of tests for DVB transport streams (shown in Figure 2–19). The Group node is split into priority groups: First Priority, Second Priority, and Third Priority. Each of these priority groups contains a number of individual tests.



Test grouping differs between digital video standards. However, all of the currently implemented standards contain a subset of the relevant TR 101 290 tests. Note that in standards other than DVB, the tests are not numbered.

Where relevant, PIDs will be associated with a test in the test tree when the test has either been disabled, or when it has failed.

The LED associated with each node indicates the status of the node and its child node tests (see *Error Status LEDs* on page 2–26). Total entries in the Event Log for each group of tests and for each test are indicated in parenthesis; resetting a group of tests or a test restarts the count in parenthesis.

### Test Filtering

Interpreting the display of tests can be made easier using the three filter buttons at the top of the Tests navigation view.

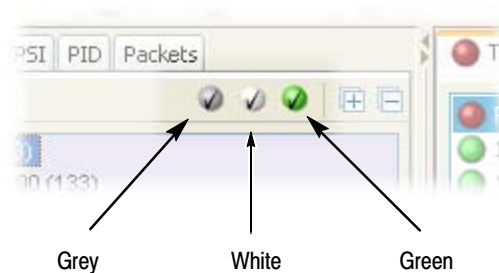

**Figure 2-20: Test filtering buttons**

Each button, when selected, will hide a category of tests in the display.

- When you select the grey button, tests that are currently disabled will not be displayed in the test tree.
- When you select the white button, tests that currently have either unknown or not applicable status will not be displayed in the test tree.
- When you select the green button, tests that currently have OK status will not be displayed in the test tree.

## Tests Navigation - All Tests

The detail view when the All Tests node is selected is shown in Figure 2–18 on page 2–43. In addition to a summary of all tests, the event log shows the most recent 10000 events that have occurred during analysis of the stream.

### Test Failures View

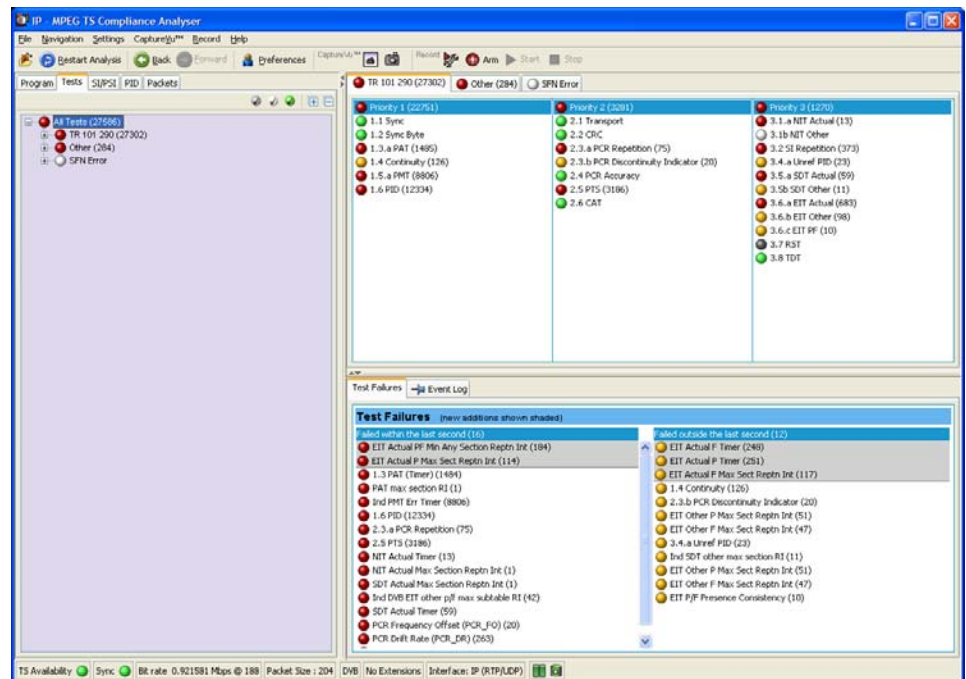

**Figure 2–21: Test Failures screen**

The Test Failures view provides an overview of the tests that have failed during stream analysis. The view is divided into two panes. The left panes shows those tests that have failed in the last second. The right pane shows those tests that have failed, not including those that have failed in the last second, and are displayed on the left side.

If a test fails, it will be displayed on the left side. When it no longer fails, it will be removed from the left side and listed on the right side as a test that has previously failed. If the test fails again, it will be removed from the left side and redisplayed on the right side until it no longer fails.

Additionally, tests that have been listed (in either pane) in the last second are displayed at the top of the list and shaded.

## Test Navigation - Test Nodes

When you select a test node, the Associated PIDs pane displays a summary of all of the PIDs and an event log listing all events that are associated with the test. Where parameters are applicable to the test, you can modify them under the Parameters tab.

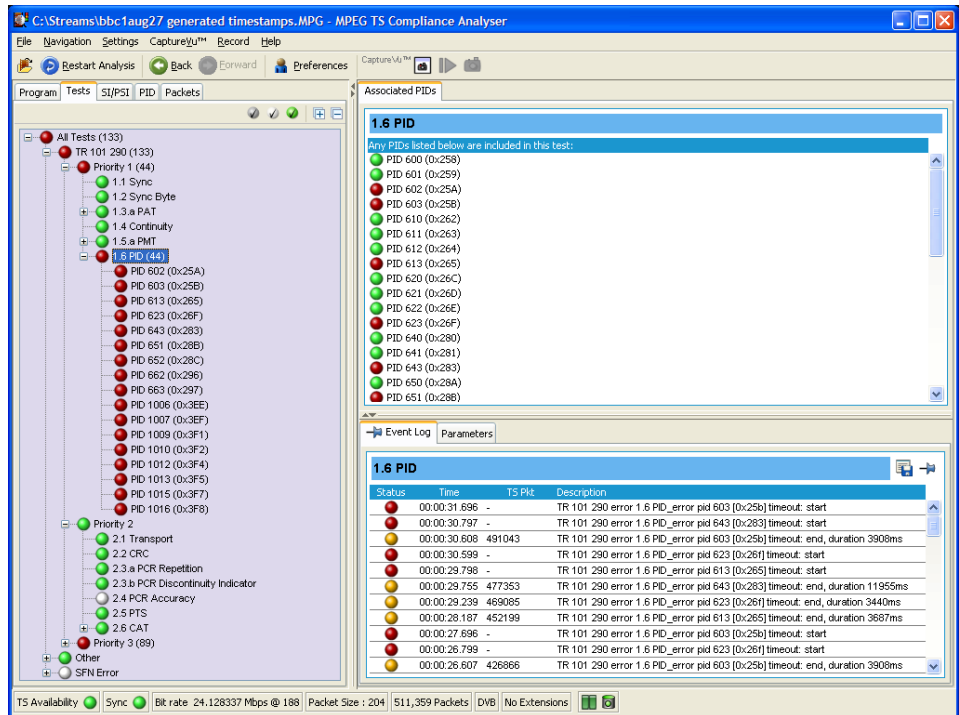

## Test Navigation - PID Nodes

Where tests have failed, the PIDs affected are listed under the test node in the Tests navigation view. Selecting a PID will display the Event Log, Parameters for the PID, and the test in the detail view.

The screenshot displays the MPEG TS Compliance Analyser interface. The left pane shows a tree view of tests, with '1.6 PID (44)' expanded to show 'PID 623 (0x26F)' selected. The main pane shows the 'Event Log' for this PID, listing various error events. A 'Parameters' dialog box is also visible, showing the 'PID Error Timeout Interval' set to 1000 ms.

Status	Time	TS Pkt	Description
●	00:00:30.599	-	TR 101 290 error 1.6 PID_error pid 623 [0x26F] timeout: start
●	00:00:29.239	469085	TR 101 290 error 1.6 PID_error pid 623 [0x26F] timeout: end, duration 3440ms
●	00:00:26.799	-	TR 101 290 error 1.6 PID_error pid 623 [0x26F] timeout: start
●	00:00:25.405	407582	TR 101 290 error 1.6 PID_error pid 623 [0x26F] timeout: end, duration 3706ms
●	00:00:22.695	-	TR 101 290 error 1.6 PID_error pid 623 [0x26F] timeout: start
●	00:00:21.301	341736	TR 101 290 error 1.6 PID_error pid 623 [0x26F] timeout: end, duration 1502ms
●	00:00:20.799	-	TR 101 290 error 1.6 PID_error pid 623 [0x26F] timeout: start
●	00:00:19.712	316242	TR 101 290 error 1.6 PID_error pid 623 [0x26F] timeout: end, duration 3912ms
●	00:00:16.789	-	TR 101 290 error 1.6 PID_error pid 623 [0x26F] timeout: start
●	00:00:15.241	244520	TR 101 290 error 1.6 PID_error pid 623 [0x26F] timeout: end, duration 3942ms
●	00:00:12.297	-	TR 101 290 error 1.6 PID_error pid 623 [0x26F] timeout: start
●	00:00:11.290	181123	TR 101 290 error 1.6 PID_error pid 623 [0x26F] timeout: end, duration 4290ms
●	00:00:07.998	-	TR 101 290 error 1.6 PID_error pid 623 [0x26F] timeout: start
●	00:00:06.404	102751	TR 101 290 error 1.6 PID_error pid 623 [0x26F] timeout: end, duration 4705ms
●	00:00:02.691	-	TR 101 290 error 1.6 PID_error pid 623 [0x26F] timeout: start
●	00:00:01.086	17433	TR 101 290 error 1.6 PID_error pid 623 [0x26F] timeout: end, duration 1087ms
●	00:00:01.000	-	TR 101 290 error 1.6 PID_error pid 623 [0x26F] timeout: start

Description	Value	Units	Min	Max	Nominal
PID Error Timeout Interval	1000	ms	1000	80000	1000





## Using the Tables View

The Tables view (SI/PSI tab) displays service information in tree form, as in the other navigation views. The tree represents the service information tables that have occurred in the analyzed stream and which comply with the selected digital video standard. This includes MPEG program specific information, DVB service information, ATSC and ISDB program information, and system information protocol. The tree contains nodes for each table found; tables/nodes are grouped together by functionality. Figure 2–22 shows an example of the Table navigation view with DVB stream interpretation selected.

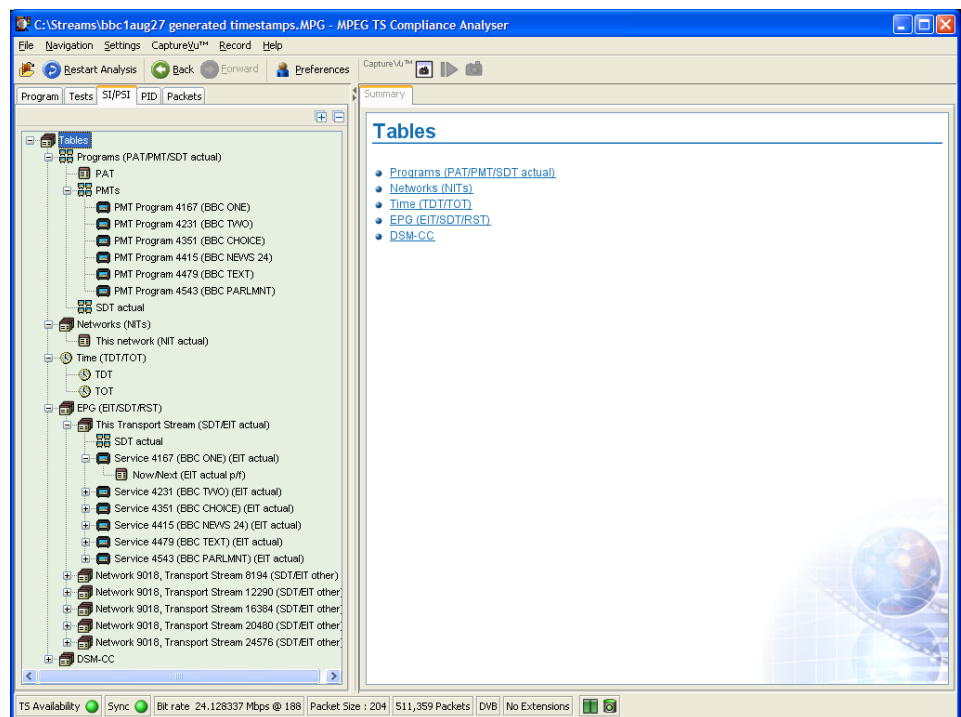

**Figure 2–22: Tables view**

Every node within the service information tree has a corresponding summary view. Nodes that represent tables will also provide you with access to the table structure and hex data (see *Tables Detail View - Section View* on page 2–53), and graphical displays of data rates and interval data (see *Tables Detail View - SI Repetition Graphs* on page 2–55).

Some of the nodes that represent less common tables or table groups may not have specific summary views available in the analyzer. In these cases, a generic summary view is used.

## Table Summary Pane

The table summary view provides a summary of the table related information for the analyzed transport stream. There is a table summary view for every node of the service information. The content is dictated by the selected node.

All summary views for nodes that represent an individual table or subtable will display the table identity and version number of the table from which the information is extracted. Where relevant, links (underlined text) are provided to associated objects, for example, in the programs summary (Figure 2–23), links are provided to the individual program summary views. Similarly, arrow icons provide links to the electronic program guide (EPG) tables. Where the section is carried on a PID, a link is also provided to the PID view.

Figure 2–23 shows an example of the summary pane with the PMT PIDs node selected in the navigation view.

The screenshot shows the MPEG TS Compliance Analyser interface. The left pane displays a tree view of tables, with 'PMTs' selected under 'Programs (PAT/PMT/SDT actual)'. The right pane shows the 'Programs' summary view, which contains a table listing 6 programs. The table has columns for Program, PMT PID, Name, and EPG. The data rows are as follows:

Program	PMT PID	Name	EPG
<a href="#">4167 (0x1047)</a>	<a href="#">PID 4167 (0x1047)</a>	BBC ONE	
<a href="#">4231 (0x1087)</a>	<a href="#">PID 4231 (0x1087)</a>	BBC TWO	
<a href="#">4351 (0x10FF)</a>	<a href="#">PID 4351 (0x10FF)</a>	BBC CHOICE	
<a href="#">4415 (0x113F)</a>	<a href="#">PID 4415 (0x113F)</a>	BBC NEWS 24	
<a href="#">4479 (0x117F)</a>	<a href="#">PID 4479 (0x117F)</a>	BBC TEXT	
<a href="#">4543 (0x11BF)</a>	<a href="#">PID 4543 (0x11BF)</a>	BBC PARLMNT	

Figure 2–23: Tables view - Programs (example)

**EPG Views** A specific departure from the Table Summary view described previously is the EPG view that is displayed when a section of the EPG table is highlighted. For a description of the general presentation of the EPG view, see page 2–115.

## Tables Detail View - Section View

The detailed section view is available when the selected node in the service information tree represents a table or subtable in the transport stream. During real-time analysis the view is continually updated.

The subtable identity, version, and section are displayed at the top of the table pane.

**NOTE.** In deferred mode, where two or more subtables, versions or sections are found in the stream, the relevant field is active and an alternative selection can be made from the drop-down list.

In real-time mode, only the latest version and section can be viewed.

The screenshot displays the MPEGS Compliance Analyser interface. The left pane shows a tree view of the transport stream tables, with 'Tables' expanded to show 'Programs (PAT/PMT/SDT actual)'. The main pane shows the 'Subtable' details for 'table\_id 2 (0x2), program\_number = 4167 (0x1047), pid = 4167 (0x1047)'. The 'PMT' section is expanded, showing fields like 'table\_header', 'section\_syntax\_indicator', 'section\_length', 'program\_number', 'version\_number', 'current\_next\_indicator', 'section\_number', 'last\_section\_number', 'PCR\_PID', 'program\_info\_length', 'descriptors', 'elementary\_streams', and 'stream\_identifier\_descriptor'. A hex dump at the bottom shows the raw data for the selected section.

The table pane shows all fields that make up a section (for example, PMT). The fields are arranged in a hierarchical order. The presence of subordinate fields is indicated using { } bracket symbols adjacent to the container field. The container can be expanded or collapsed by clicking the + or – icon.

Below the table pane, the data source is displayed. The data pane shows the data bytes (in both hexadecimal number format and ASCII character format) for the selected table, version, and section. When a node is selected in the table pane, the bytes that make up the selected node (including the subordinate nodes) are highlighted in the hexadecimal data pane (refer to Figure 2–24).

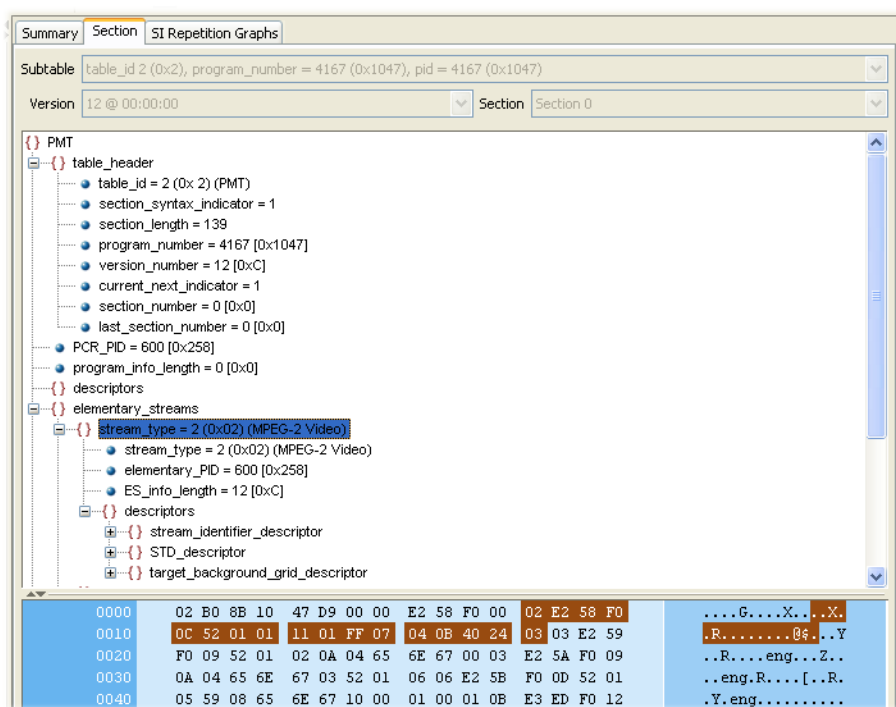

Figure 2–24: Section payload

If the section is corrupt or empty, the hexadecimal view background is red instead of blue.

## Tables Detail View - SI Repetition Graphs

The section graph view will be available when the selected node in the service information tree represents a table or subtable in the transport stream. You can view graphs of the following data:

- Section repetition interval:  
This graph displays the interval between two sections of a table on a particular PID.
- Subtable intersection gap:  
This graph displays the interval between sections in a particular subtable.
- Subtable repetition interval:  
This graph displays the time between receiving one complete subtable and receiving the next complete subtable.

---

**NOTE.** *Not all of the above graph types are relevant to all table types.*

*Graph Management is described in more detail in the Common User Interface Concepts section of this manual (see page 2–85).*

---



# Using the PID View

The PID view displays information about all of the PIDs found in the transport stream being analyzed. The navigation view contains the PID tree structure representing all of the PIDs that have occurred within the transport stream.

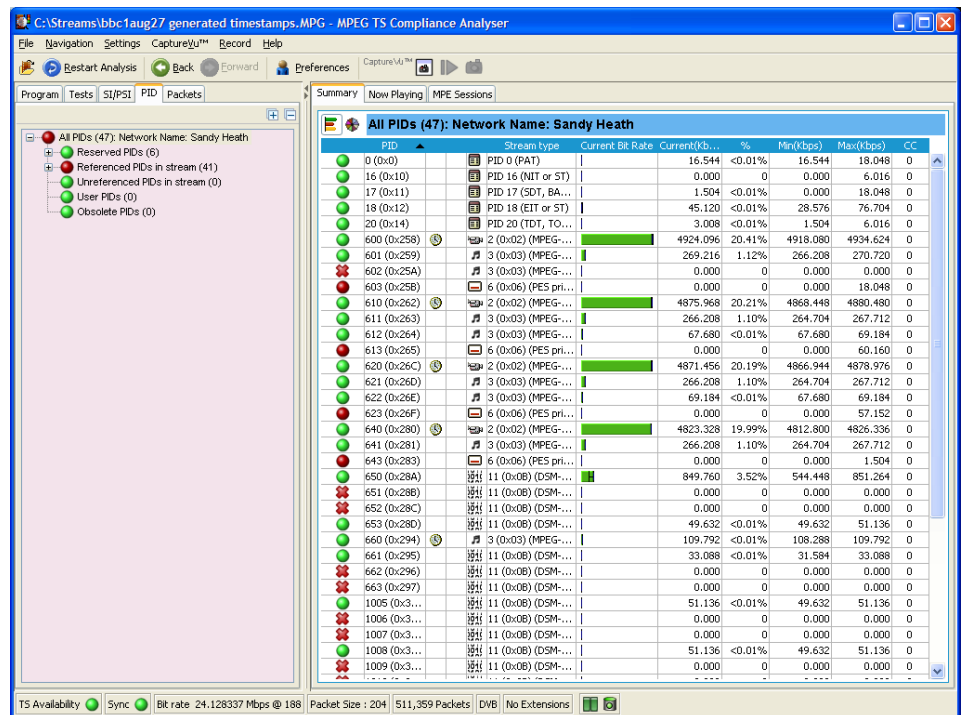

In DVB analysis mode, the MPE tab is always present. However, the MPE view will only be populated when MPE data is present in the stream (see page 2–119).

## PID View - All PIDs

In the navigation view, PIDs are grouped under the following subordinate nodes:

- Reserved PIDs
- Referenced PIDs
- Unreferenced PIDs
- User PIDs
- Obsolete PIDs (deferred analysis only)

The number of PIDs in each group is shown adjacent to the node. The root node label shows the total number of PIDs found and the Network Name.

When highlighted, the All PIDs node displays in the detail pane all of the PIDs found in the analyzed stream.

Each of these subordinate nodes contains PIDs belonging to that group. PIDs are allocated during analysis, and the number of PIDs is identified for each node. You can also allocate PID numbers to the User PID node, although User PIDs may not necessarily have been found in the stream. This feature allows you to compare the properties of one or more PIDs more easily.

The associated summary view provides a PID-oriented overview of the transport stream, allowing you to see the relative data rates of all of the PIDs contained within the transport stream. The information can be displayed as either a bar chart, or as a pie chart. Columns in the summary views can be sorted in ascending or descending order by clicking on the column header. PID related information is available under the PID Information tab.

Each PID is associated with a number of tests. If one or more tests fail, they will be listed under the relevant PID node in the navigation view. Selecting the PID node will display a summary, in the detail view, of all associated tests that have been found. Selecting a specific test in the Associated Tests pane will display the Event Log and Parameters for only that test.



## PID View - Detail View (All PID and PID Group)

The All PID and PID Group detail view provides you with a PID-oriented overview of the transport stream. This view is displayed when any of the main nodes is selected in the navigation pane: All PIDs, Referenced PIDs, Unreferenced PIDs, or User PIDs.

The view shows the relative data rates of all of the PIDs contained within the selected node. You can display the information in either a bar chart or a pie format. The associated test states are shown in all views.

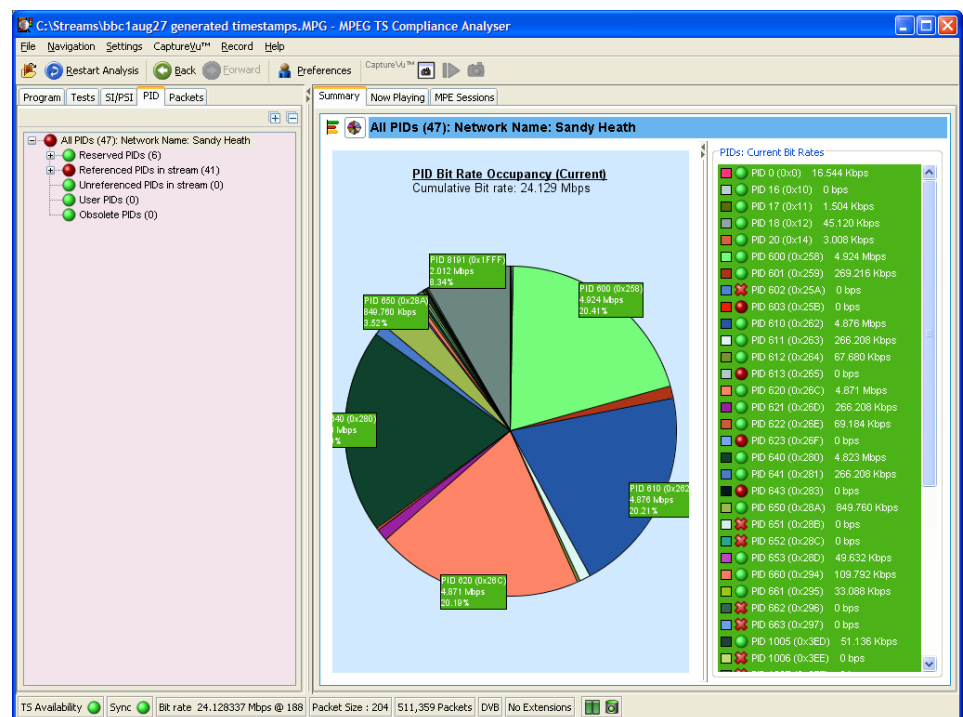

from the shortcut menu. The packet will be added to the PIDs list (in the Packets view).

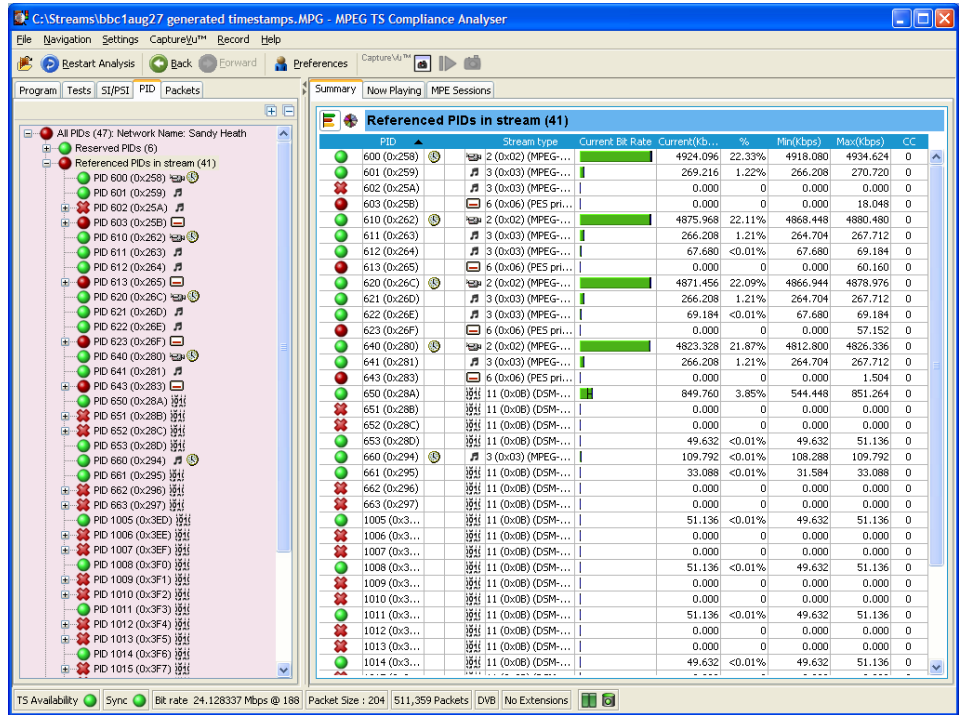

Figure 2-26: PID Information view

## PID View - Detail View (PIDs)

The individual PID detail view provides you with information about the selected PID. This view will be visible when you select an individual PID node in the PID tree. Where a PID has failed a test, one or more test nodes are displayed as child nodes of the PID.

The combination and detail of the views vary depending on the selected PID type and node.

During deferred or captured analysis, the packets carrying the PID can be examined in more detail by highlighting a PID, and selecting the Go to Packets view from the shortcut menu.

### Ordinary PID Selected

When a PID does not contain PCRs, the main view in the PID pane is the Associated Tests view. This view lists the tests associated with the selected PID. The status of the individual tests is indicated with LED icons. Also available are Bit rate Graphs which show the bit rate of the selected PID in graphical form.

Also on the Associated Tests tab is an event log and a parameters pane. The event log shows all PID related events. If a test is selected in the PID pane, only the events associated with that test on that PID are shown. Similarly, when a test is selected, the Parameters pane shows the parameters associated with that test (when applicable).

### PCR PID Selected

When the selected PID contains PCR information, PCR inaccuracy and PCR interval data graphs will be displayed in addition to a bit rate graph. When the transport stream contains time stamped data, the PCR overall jitter, the PCR frequency offset, and the PCR drift rate graphs will also be available. For real-time IP analysis, the Packet Interval Timing (PIT) graph is also available (see page 2–101).

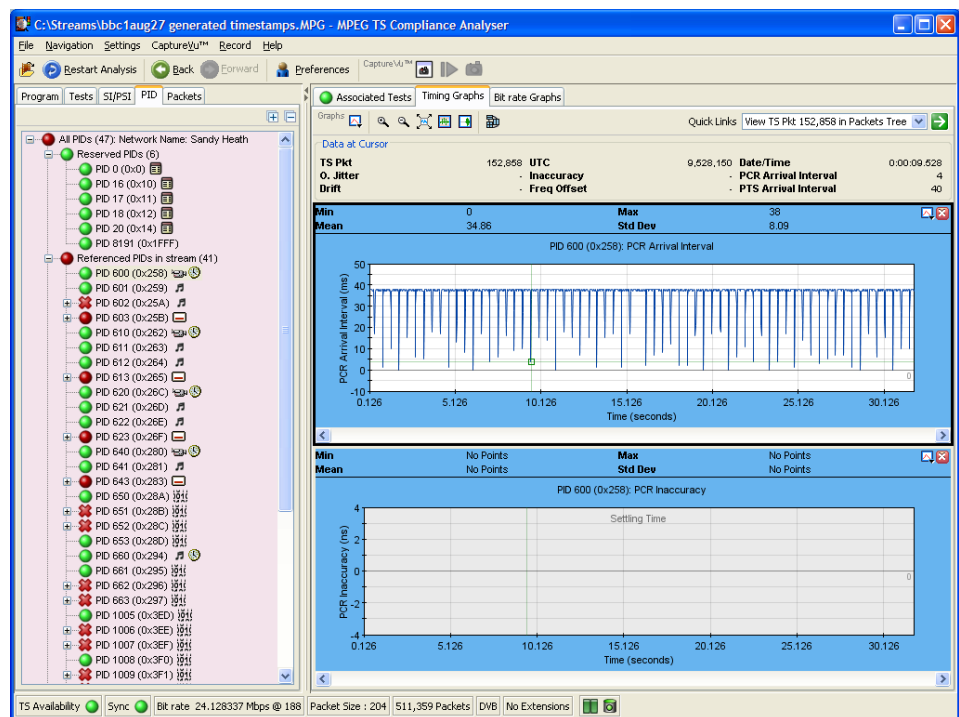

A Presentation Time Stamp (PTS) graph may also be available on PIDs carrying audio and video information.

(See also *Graph Management*, page 2–91 and *Timing Graphs*, page 2–97.)



# Using the Packets View

**NOTE.** The Packets view is available only during deferred analysis and CaptureVu analysis.

Data in the stream is carried in 188- or 204-byte packets. The Packets view allows you to examine the contents of each packet in the analyzed stream.

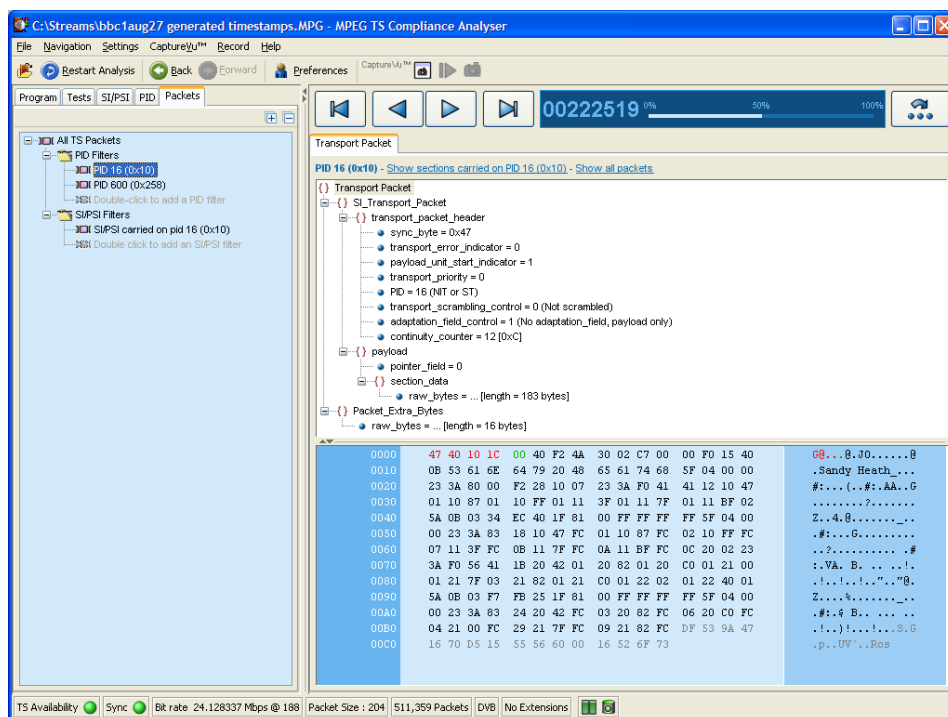

The packet navigation view shows a tree structure which represents the packets within a stream grouped according to content, including PID value, SFN mega-initialization packets (MIPs) (DVB only), and ISDB-T information packets (IIPs).

The All Packets, MIP and IIP nodes do not have any child nodes. The All Packets node represents all of the packets in the transport stream. The MIP node represents all of the DVB SFN MIPs in the transport stream. The IIP node represents all of the ISDB-T information packets in the transport stream.

The PIDs node represents all of the PIDs that are of interest. You can add PIDs in the transport stream to this node, and to PIDs that are contained within the user PID list.

Selecting any leaf node in the packet tree will apply a packet filter to the associated packets. For example, selecting a PID node will only allow packets carrying that particular PID to be displayed in the associated summary view. Similarly, selecting the MIP node will only allow MIP information to be displayed in the associated summary view.

## Packet Navigation Bar





In the packet summary view, you can use the top bar to navigate the packets in the stream.

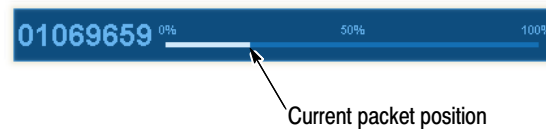

The packet position bar shows the position of the selected packet in the stream.



The navigation bar functionality depends on the selection in the packet navigation view. If you select All Packets, the controls will operate on all packets. If you select a single PID, a filter is in operation, and the controls will work only for those packets carrying that PID.

	Selects the first available packet (in the stream or carrying the selected PID)
	Selects the previous available packet (in the stream or carrying the selected PID)
	Selects the next available packet (in the stream or carrying the selected PID)
	Selects the last available packet (in the stream or carrying the selected PID)
	Opens the Go To Packet dialog box

You can also use the packet position bar to navigate through the stream. To do so, use the cursor to point to and click the next packet to be displayed. Double-click the packet number in the bar to open the Go To Packet dialog box. Enter the required packet number and select OK. For both methods, remember that the destination packet is dependent on the node selected in the navigation view.

## Packet Navigation - Filter Nodes

The packet filters allow you to view packets carrying PID.

To inspect the sequence of packets carrying a particular PID, you must add the PID to the PID Filters node in the Packet Navigation view. PIDs carrying sections can also be viewed. You can add as many PIDs as are required. There are a number of ways to add a PID to the node; as described in the following paragraphs.

### Adding a PID in the Packet View

1. In the Packet view, expand the PIDs node by doing one of the following:
  - Double-click the child node (double-click to add a PID)
  - Select Add PID... from the PIDs node shortcut menu
2. In the Add PID... dialog box, expand the nodes, locate and select the required PID.
3. Click OK.

The selected PID is added to the PIDs node, and the first occurrence of a packet carrying the selected PID is displayed in the summary view.

Added PIDs will be stored when the application is closed. They will be reinstated when the application is reopened. However, if a different stream is analyzed, the stored PIDs may not be used.

### Removing PIDs

All PIDs previously added to the PID node can be removed by selecting Remove All from the PIDs node shortcut menu.

## Packet Detail View

The detail view shows the fields and data that are contained in a packet. The fields are arranged in a hierarchical order. The presence of subordinate fields is indicated using { } bracket symbols adjacent to the container field. To expand or collapse the container, click the + or - icon.

Below the table pane, the data source is displayed. The data pane shows the data bytes (in both hexadecimal number format and ASCII character format) for the selected packet. When you select a node in the table pane, the bytes that make up the selected node (including the subordinate nodes) are highlighted in the hexadecimal data pane.

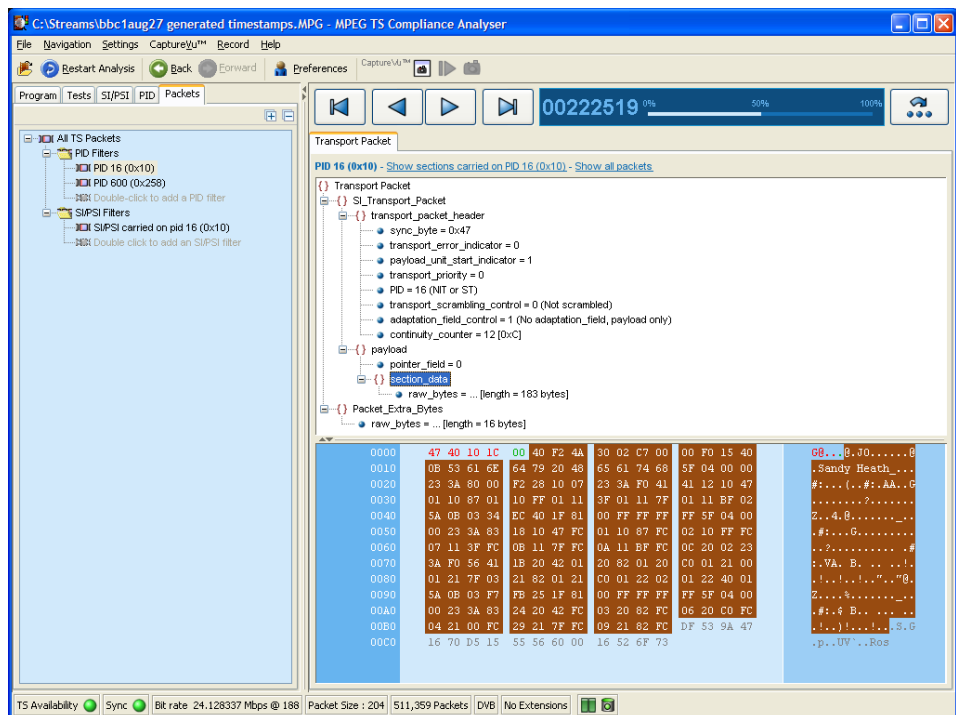

The packet transport header bytes are displayed in red. Similarly, bytes greater than 188 are displayed in gray. The adaptation field, where present, is displayed in blue.

If the section is corrupted or empty, the background of the hex view is red instead of blue.



**ISDB Streams**

Figure 2–27 and Figure 2–28 show an example of the packet detail view with an analyzed ISDB-T stream. Note the IIP tab and the additional TMCC and IIP nodes.

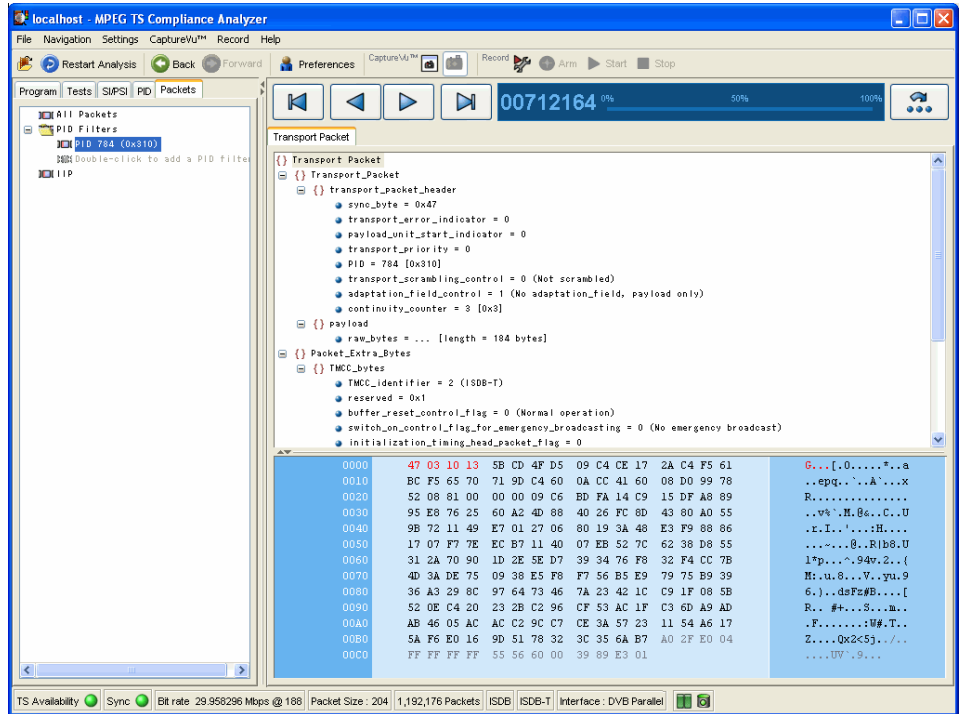

**Figure 2–27: Packet view - ISDB detail -IIP**

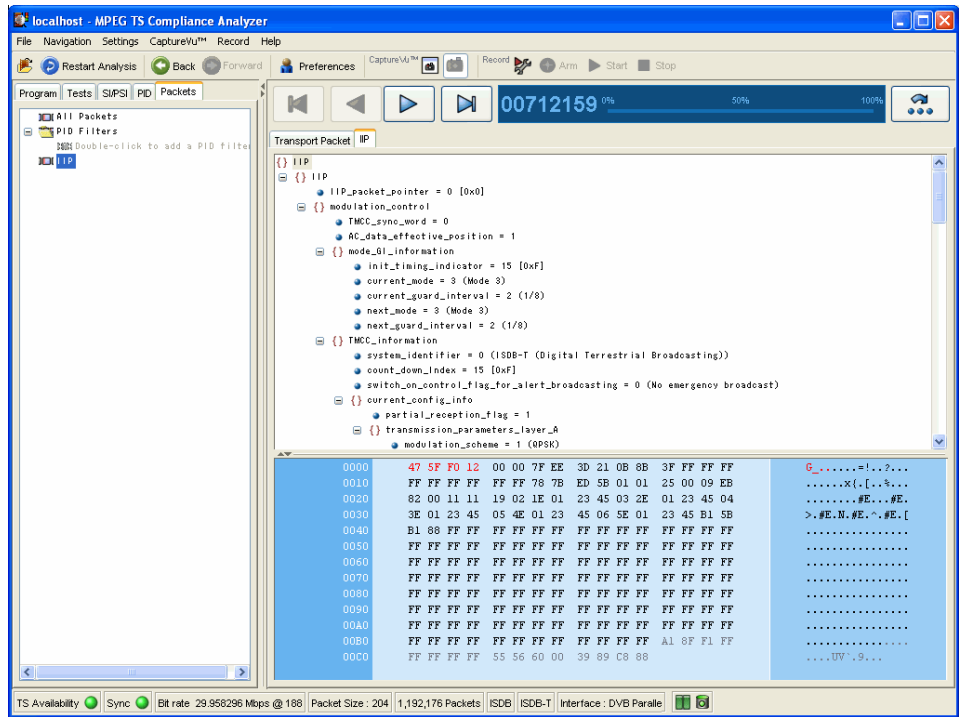
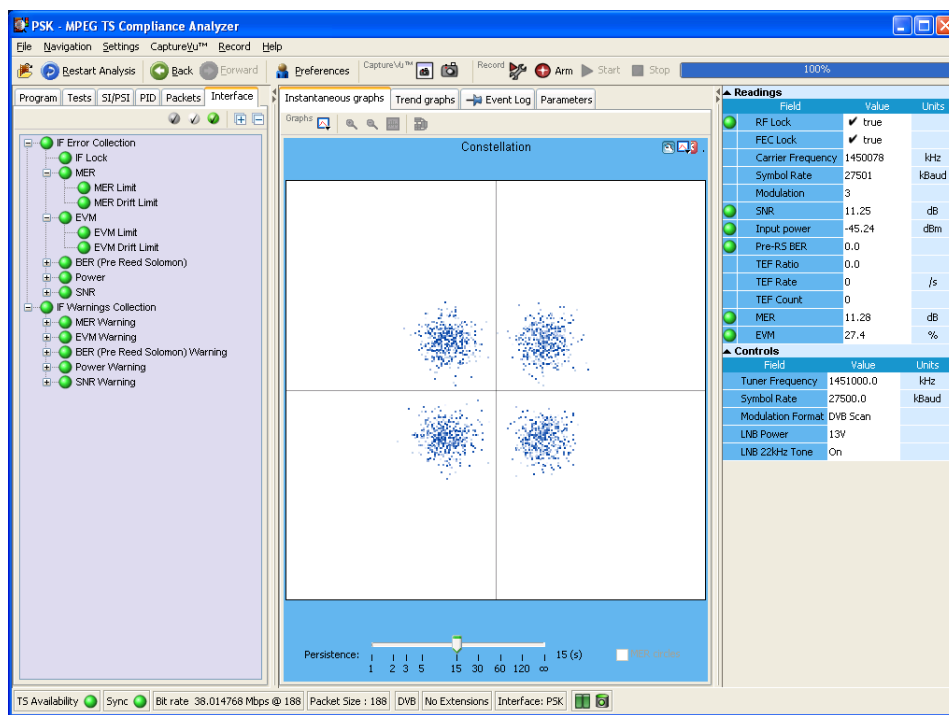

Figure 2-28: Packet view - ISDB detail - Transport packet

# Using the Interface View

If real time analysis using an interface card is invoked, the Interface tab is displayed in the Navigation view of the TSCA window.

**NOTE.** The Interface view is available only if an interface card is selected for real-time analysis.



**Figure 2–29: Interface View - Example**

Two interface card test nodes are displayed in the navigation view: IF Error Collection and IF Warning Collection. Each collection contains a range of tests (see Figure 2–29).

The detail of the interface view is different for each interface type.

## Detail View Tabs

The detail view contains four tabs: Instantaneous graphs, Trend graphs, Event Log, and Parameters. This section describes the tabs in general terms. The following sections describe in detail the tabs associated with each interface type.

- Instantaneous Graphs**      The instantaneous graphs display instantaneous measurements in graphical form.
- Trend Graphs**              The trend graphs display trends in measurements in graphical form.
- Event Log**                    The event log displays a history of the events related to the item selected in the navigation view.
- Parameters**                 The parameters tab display the parameters associated with the test highlighted in the navigation view. Parameter editing is described in the *Common User Interface Concepts* section, page 2–104.

## Readings and Controls

The right panel contains Readings and Controls. The Readings area displays values received from the card itself.

The RF Lock LED conveys different types of information. If full lock onto the channel is acquired and it is receiving the signal correctly, the LED will light up green. When a signal is present but no lock is achieved, the indicator is red. When no signal is found, the indicator is gray.

In the Readings area, the LED colors are as follows:

Green	On
Red	Out of range or failed test
Gray	Off or not applicable

The Readings background colors are as follows:

White	In range
Red	Out of range; for example, too much or too little power or out of order packets per second being greater than zero
Yellow	Not recently updated
Gray	Not applicable; for example, out of order packets not being available when the UDP protocol is selected

The Controls area contains user controls. Values entered here will be applied to the card and will affect its performance. These controls correspond exactly with those on the Open Transport Stream dialog box.

## RF Interface Card Overview

This section describes the configuration and interpretation of results of the RF interface cards that may be installed in MTS400 Series MPEG Test Systems.

The interface settings described are as follows:

- QAM (Quadrature Amplitude Modulation) (Annex B II) (see page 2-74)
- COFDM (Coded Orthogonal Frequency Division Multiplexing) (see page 2-77)
- QPSK/8PSK (Phase Shift Keying) (see page 2-82)
- 8VSB (Vestigial Side Band) (see page 2-80)

(Refer to the *MTS400 Series Technical Reference*, 071-1724-xx for the interface technical specifications.)

Only one RF interface card can be installed in the MTS400. All RF interface measurements and graphs include a constellation diagram with MER rings, EVM, SNR, and BER measurements. The installed interface can be used simultaneously with an IP input. All interfaces have dual-level warning and failure alarms plus RF drift tests for long term trend monitoring.

The input card screen and configuration of the card will depend on which interface card is installed.

## RF Interface Card Set Up

The RF interface card configuration is set up when analysis is started using the Open Transport Stream dialog box. The settings can subsequently be changed during analysis from the Interface View.

When real-time analysis is selected and an RF interface is selected from the Interfaces drop-down list. The Firmware Version and the current Interface Settings of the card are displayed.

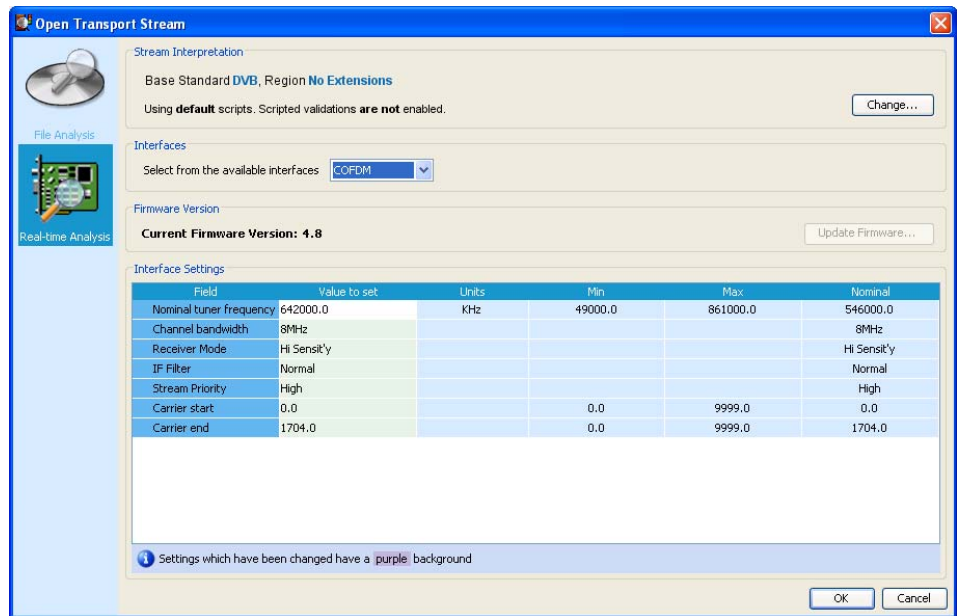

**Figure 2-30: Open Transport Stream dialog box**

If the firmware version is incorrect, the Update Firmware... button is enabled, and you will not be able to proceed with the setup and analysis until the firmware is updated (see page 2-73).

1. In the Open Transport Stream dialog box, select Real-time Analysis.
2. Select the RF interface from the Interfaces drop-down list.
3. Enter the interface settings required (see the following pages for descriptions of the settings for each RF interface card).
4. Select OK to start the analysis.

The name of the interface selected is displayed in the TSCA status bar.

## RF Interface Card Firmware Update

If the interface card firmware needs updating, a message will be displayed when real-time analysis is selected. The Update Firmware... button will also be enabled.

Update the interface card firmware as follows:

1. Select Update Firmware....
2. In the Update Firmware dialog box, select Start.

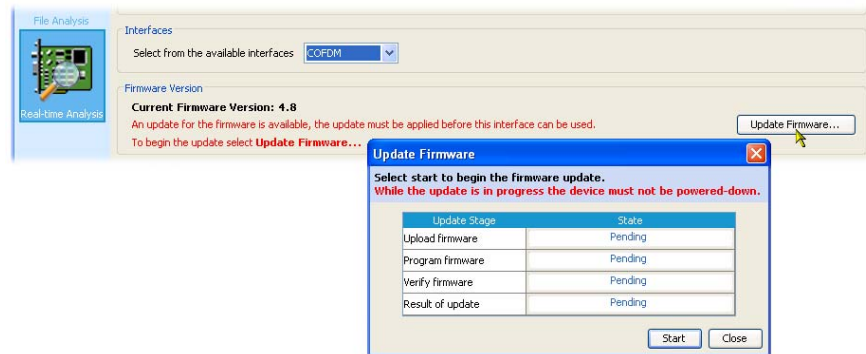

**Figure 2-31: RF Firmware update**

3. The dialog box will display progress of the update. The box will close when the update is complete.



**CAUTION.** Removing power from the MTS400 while the firmware upgrade is in progress can cause fatal corruption of the firmware files.

## RF Interface View Screens

This section describes the settings and displays associated with the RF interface cards.

### RF Interface - QAM (Annex B)

The settings and displays of the QAM (Annex B) RF interface card are as follows: QAM(B) Interface Settings, QAM(B) Instantaneous Graphs, and QAM(B) Trend Graphs.

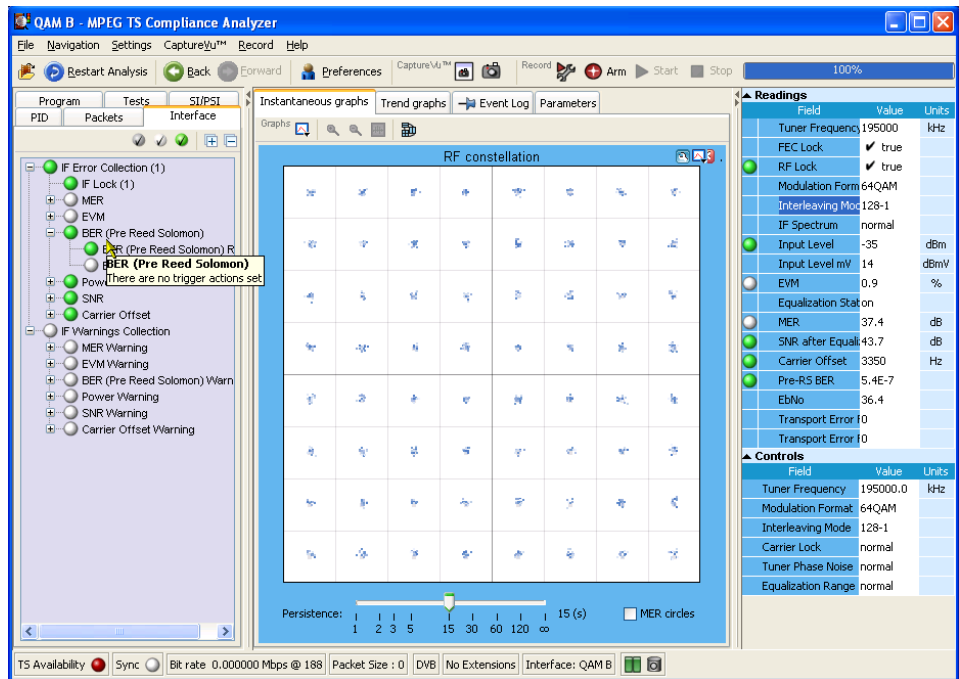

Figure 2-32: Interface View - RF - QAM (Annex B)

**QAM(B) Interface Settings.** The following QAM (Annex B) settings are available on the Open Transport Stream - Real Time Analysis dialog box, and also in the Interface tab - Controls area.

**Tuner Frequency (kHz):** This value, set in kHz units, is the center frequency of the channel to be received. Any frequency can be entered. There is no need to follow a channel plan. The frequency resolution is determined by the tuner step size of 62.5 kHz.



- Modulation Format:** This drop down list allows 64 QAM or 256 QAM operation to be selected. Note that SCTE07 and ITU-Tj83 annex B specify exact symbol rates for the two modulation formats, so there is no dialog box to enter the symbol rate separately.
- Interleaving Mode:** Interleaving assists in the correction of burst noise induced errors. All interleaving modes mentioned in SCTE 07 are supported, including all Level II modes up to  $I = 128$   $J = 6$ .
- Carrier Lock:** This allows the carrier lock range to be increased from the normal  $\pm 150$  kHz to approximately  $\pm 500$  kHz. This is useful if you are attempting to lock on to badly mistuned or wandering carriers.
- Tuner Phase Noise:** This control modifies the carrier loop bandwidth to allow the acquisition of noisy carriers. Normal mode is recommended for general use.
- Equalization Range:** The channel equalizer can be configured to give a long equalization range, at the expense of equalizer resolution, or, in normal mode, optimized for typical cable environments. Normal mode is recommended for general use.

**QAM(B) Instantaneous Graphs.** The following instantaneous graphs are available for the QAM (Annex B) RF interface card.

- RF Constellation:** I and Q data are collected from the QAM front end and displayed as a conventional constellation of 256 points by 256 points. The samples collected are not real time, so there is some dwell (delay) before a complete constellation is displayed. The persistence of the display can be varied using the Persist slider control at the bottom of the graph.

MER (Modulation Error Ratio) and EVM (Error Vector Magnitude) calculations are performed on the constellation data according to the formulas in ETR290-101.

- SNR after equalizer:** This graph represents the signal-to-noise ratio over time, typically over 256 seconds. It is useful for examining signal-to-noise trends, for example, if an alarm condition has been breached, the graph can be used to examine trends in the signal-to-noise performance before the alarm occurred.

<b>MER:</b>	This graph gives a time record of MER over the last 255 seconds.
<b>Equalizer:</b>	This graph shows the status of the equalizer taps, and gives an estimate of the channel state. If there are echoes or other time related distortions on the signal, the Equalizer display will display the amplitude of the corresponding tap correction values versus time.

---

**NOTE.** *The Equalizer graph amplitude values are approximate.*

---

**QAM(B) Trend Graphs.** The trend graphs extend the principle of the instantaneous graphs by graphing measurements over longer periods. Each graph is associated with a measurement that is also displayed in the Readings panel on the right side of the display. The measurements have status LEDs associated with them.

Individual trend graphs can be opened by making a selection from the drop-down menu of the Trend graph or from the context menu of the measurement in the Readings panel.

The following trend graphs are available for the QAM B interface card: RF Lock, MER, EVM, Pre-RS BER, Input Level, SNR after Equalizer, and Carrier Offset.

**RF Interface - COFDM**

The settings and displays of the COFDM RF interface card are as follows: COFDM Interface Settings, COFDM Instantaneous Graphs, and COFDM Trend Graphs.

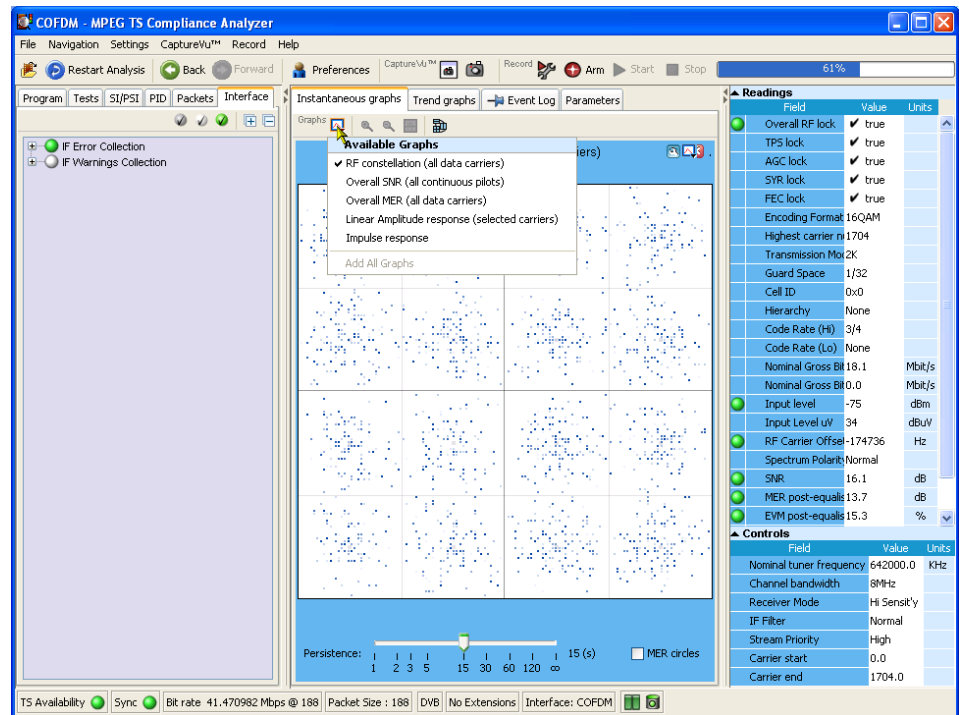

**Figure 2–33: Interface View - RF - COFDM**

**COFDM Interface Settings.** The following COFDM settings are available on the Open Transport Stream - Real Time Analysis dialog box, and also in the Interface tab - Controls area.

**Nominal Tuner Frequency:**

This value, set in kHz units, is the center channel frequency of the DVB-T channel to be received. For example, to receive channel E21, set this value to 474000 kHz. Any frequency can be entered. There is no need to follow a channel plan. The frequency resolution is determined by the tuner step size.

**Channel Bandwidth:** The COFDM interface card supports operation in 8 MHz, 7 MHz, and 6 MHz channels. Select the desired channel bandwidth from the drop-down menu.

- Receiver Mode:** To achieve high accuracy measurements, particularly for MER and SNR measurements, the COFDM IF card supports two modes of operation.
- For conventional COFDM reception, a relatively low ultimate SNR is acceptable. For example at 64 QAM, an ultimate receiver SNR of 30 dB can result in a reduction in system performance of only 0.5 dB. However, for more detailed analysis of COFDM constellations, a much higher ultimate SNR is required, preferably in excess of 40 dB. For this reason, two modes of COFDM operation are provided.
- High Sensitivity** mode gives the full dynamic range of a conventional COFDM receiver, but at the expense of ultimate SNR. The **High Resolution** mode modifies the signal path to dramatically reduce the noise generated in the receiver, giving a much higher ultimate SNR, but at the expense of receiver sensitivity. So for general purpose monitoring where the input signal may vary over a wide range, typically -75 dBm and lower, high sensitivity mode is preferred.
- If the signal is consistently greater than -50 dB, high resolution mode provides better RF measurement performance.
- IF Filter:** The COFDM receiver incorporates two stages of selectivity. One of these can be bypassed in WIDE mode to give a more accurate representation of the input spectrum flatness (at the expense of overall selectivity).
- Stream Priority:** When hierarchical modulation is present, the transport stream priority, HIGH or LOW, can be selected for analysis by the MPEG analyzer tools. When no hierarchy is present, this defaults to HIGH priority.
- Carrier start:** When observing carrier amplitudes ahead of the channel equalizer, this value sets the numerical value of the first carrier to be displayed, and defaults to zero.
- Carrier end:** When observing carrier amplitudes ahead of the channel equalizer, this value sets the numerical value of the last carrier to be displayed, and defaults to the maximum carrier number in the COFDM signal (1704 for 2K, 6816 for 8K modes).

**COFDM Instantaneous Graphs.** The following instantaneous graphs are available for the COFDM RF interface card.

**RF constellation (all data carriers)**

When the receiver is in RF lock, the constellation points are displayed. According to ETR290, only the data pilots are used for MER and EVM calculation. The samples collected are not real time, so there is some dwell (delay) before a complete constellation is displayed. The persistence of the display can be varied using the Persist slider control at the bottom of the graph.

MER and EVM calculations are performed on the constellation data according to the formulae given in ETR290-101. This calculation specifically excludes the TPS carriers.

**Overall SNR (all continuous pilots)**

A time line graph of measured Signal to Noise Ratio is displayed, over the preceding 255 seconds.

**Overall MER (all data carriers)**

A time line graph of measured Modulation Error Ratio is displayed, over the preceding 255 seconds.

**Linear Amplitude response (selected carriers)**

A linear amplitude response is shown for the carriers selected using the carrier START and STOP controls. Allows you to view and zoom in on frequency dependent amplitude distortions.

**Impulse response**

A channel response graph is shown, allowing time related distortions, particularly echoes, to be displayed relative to the main signal. Echoes occurring before and after the main signal are displayed. The graph is derived from the linear amplitude response, transformed into the time domain.

**COFDM Trend Graphs.** The trend graphs extend the principle of the instantaneous graphs by graphing measurements over longer periods; periods range from one minute to . Each graph is associated with a measurement that is also displayed in the Readings panel on the right side of the display; the measurements have status LEDs associated with them.

Individual trend graphs can be opened by making a selection from the drop-down menu of the Trend graph or from the context menu of the measurement in the Readings panel.

The following trend graphs are available for the COFDM interface card: Overall RF lock, MER post-equalizer, EVM post equalizer, Pre-RS BER, Pre-Viterbi BER, Input level, SNR, and RF Carrier Offset Frequency.

**RF Interface - 8VSB**

The settings and displays of the 8VSB RF interface card are as follows: 8VSB Interface Settings, 8VSB Instantaneous Graphs, and 8VSB Trend Graphs.

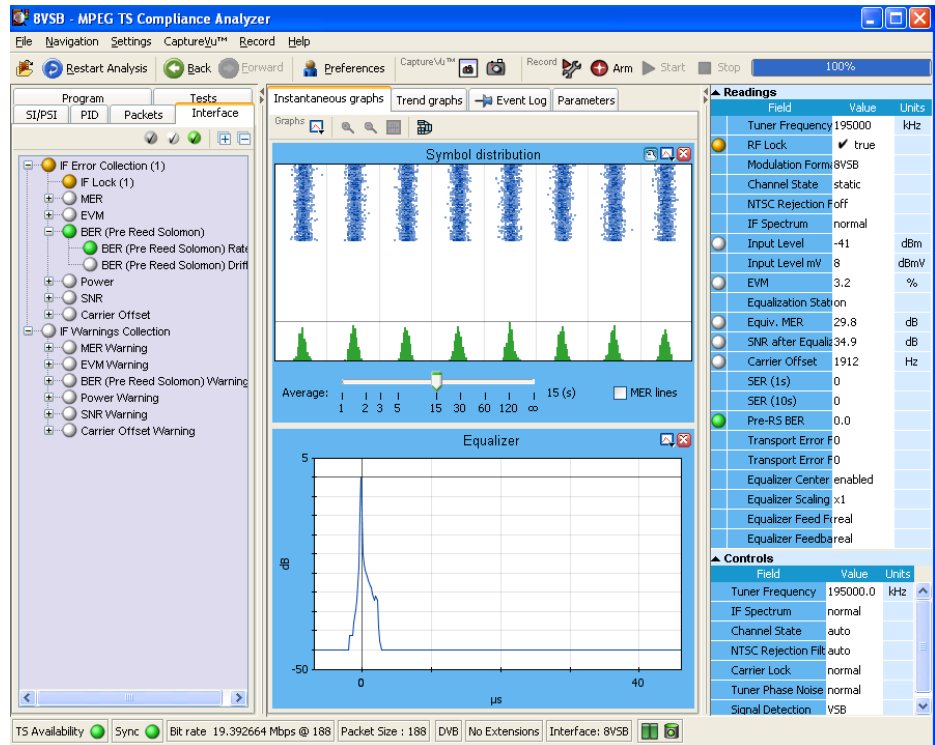

**Figure 2-34: Interface View - RF - 8VSB**

**8VSB Interface Settings.** The following 8VSB settings are available on the Open Transport Stream - Real Time Analysis dialog box, and also in the Interface tab - Controls area.

**Tuner Frequency (kHz):** Enter the required tuned (channel) frequency. Remember to enter the center channel frequency, not the “pilot” frequency.

**IF Spectrum:** This can be set to Normal or Inverse, to allow for frequency conversions in the signal chain. Conversions that use difference frequencies invert the spectrum; additive conversions do not.

- Channel State:** Available options are auto, static, dynamic and fast dynamic. Using these options you can match the receiver equalizer to the expected channel conditions. The recommended default setting is auto.
- NTSC Rejection Filter:** This setting gives you control over the integrated co-channel NTSC reject filter. Options are On, Off and Auto. The recommended default setting is Auto.
- Carrier Lock:** This setting allows you to control the carrier lock range. The Normal setting allows lock over a  $\pm 150$  kHz range; Wide extends the range to  $\pm 500$  kHz. The recommended default setting is Normal.
- Tuner Phase Noise:** (Normal and High) This control modifies the carrier loop bandwidth to allow the acquisition of noisy carriers. Normal mode is recommended for general use.
- Signal Detection NTSC:** (National Television Standards Committee) and **VSB** (Vestigial Side Band).
- 8VSB Instantaneous Graphs.** The following instantaneous graphs are available for the 8VSB RF interface card.
- Symbol Distribution:** This graph shows the samples received over time in a falling vertical line display. In a noise free system, all samples would fall on one of the eight vertical lines. However, in normal systems the samples will be displayed distributed around the vertical lines. At the bottom of the graph display, the sample values are accumulated into a distribution histogram. The histogram can be displayed in a linear or logarithmic format.
- Signal to Noise (SNR) (after equalizer):**  
The SNR values are plotted in a pen-trace style, giving a brief history of the collected values.
- Equivalent MER:** An MER (Modulation Error Ratio) calculation is performed on the in-phase (I) data samples. The quadrature data samples are ignored in this calculation.
- Equalizer:** The equalizer coefficients are plotted across the graph display. The display illustrates the presence of multi-path echoes by indicating how the equalizer is adjusting to cancel them out.

---

**NOTE.** *The Equalizer graph amplitude values are only approximate.*

---

**8VSB Trend Graphs.** The trend graphs extend the principle of the instantaneous graphs by graphing measurements over longer periods. Each graph is associated with a measurement that is also displayed in the Readings panel on the right side of the display. The measurements have status LEDs associated with them.

Individual trend graphs can be opened by making a selection from the drop-down menu of the Trend graph or from the context menu of the measurement in the Readings panel.

The following trend graphs are available for the 8VSB interface card: RF Lock, Equiv. MER, EVM, Pre-RS BER, Input Level, SNR after Equalizer, and Carrier Offset.

**RF Interface - QPSK/8PSK**

The settings and displays of the QPSK/8PSK RF interface card are as follows: QPSK/8PSK Interface Settings, QPSK/8PSK Instantaneous Graphs, and QPSK/8PSK Trend Graphs.

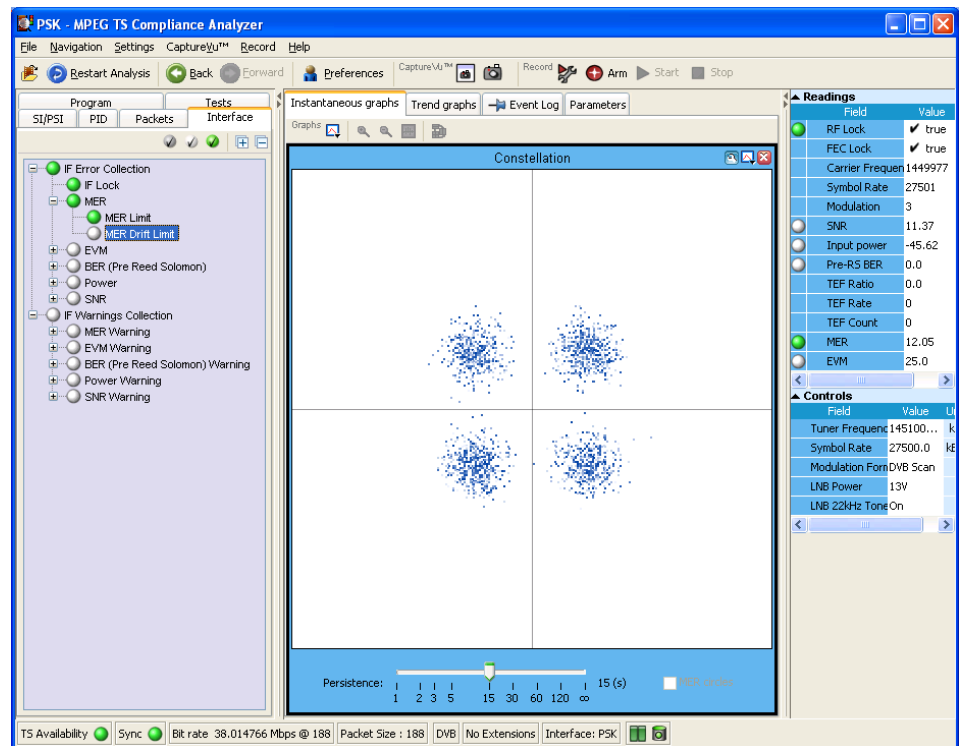

Figure 2-35: Interface View - RF - QPSK/8PSK



**QPSK/8PSK Interface Settings.** The following QPSK/8PSK settings are available on the Open Transport Stream - Real Time Analysis dialog box, and also in the Interface tab - Controls area.

**Tuner Frequency (kHz):** This value is the center frequency of the IF channel to be received (that is, after downconversion in the LNB where applicable). Any frequency can be entered; there is no need to follow a channel plan. The frequency resolution is determined by the tuner step size of 1 MHz.

**Symbol Rate (kBaud):** This value is the symbol frequency (Baud rate) of the signal to be received, over a range of 1 to 30 MBaud. You need to enter the symbol rate to a typical accuracy of 1000 ppm to ensure successful lock.

**Modulation Format:** The card supports a number of modulation formats: Turbo FEC 8PSK, Turbo FEC QPSK, DVB QPSK and Digicipher™ II. Enter the appropriate format and puncture rate (also known as the code rate) into the modulation dropdown dialog box. A Scan function is also provided, allowing automatic acquisition if the precise code rate is not known.

**LNB Power:** The QPSK/8PSK card incorporates a regulated power supply for control of a LNB (Low Noise Block) or similar equipment. The supply voltage, using the drop down dialog box, is selectable between Off (default), 13V and 18V. The output current is limited to 200 mA maximum, and is foldback limited to a low value in the event of an overload.

**LNB 22 kHz Tone:** A 22 kHz tone is provided for control of an LNB (Low Noise Block) or similar equipment. The tone, using the drop down dialog box, is selectable between Off (default) or On.

**QPSK/8PSK Instantaneous Graphs.** The following instantaneous graphs are available for the QPSK/8PSK RF interface card.

**Constellation:** I and Q data are collected from the QAM front end and displayed as a conventional constellation of 256 points by 256 points. The collected samples are not real time, so there is some dwell (delay) before a complete constellation is displayed. The persistence of the display can be varied using the Persist slider control at the bottom of the graph.

MER and EVM calculations are performed on the constellation data according to the formulas given in ETR290-101

**QPSK/8PSK Trend Graphs.** The trend graphs extend the principle of the instantaneous graphs by graphing measurements over longer periods. Each graph is associated with a measurement that is also displayed in the Readings panel on the right side of the display. The measurements have status LEDs associated with them.

Individual trend graphs can be opened by making a selection from the drop-down menu of the Trend graph or from the context menu of the measurement in the Readings panel.

The following trend graphs are available for the QPSK/8PSK interface card: RF Lock, MER, EVM, Pre-RS BER, Input power, and SNR.

# Common User Interface Concepts

Many user interface concepts are used throughout the analyzer. The following common elements are described in this section:

- Windows Management
- Icons
- Graph Management
- Timing Graphs
- Bit Rate Graphs
- PIT Graph
- Now Playing Views
- Parameter Edit
- Event Logs
- Bit Rates
- EPG View
- MPE Views
- CaptureVu Features
- Triggered Recording
- Menu Bar and Options
- Preferences
- Script Files

## Windows Management

---

**NOTE.** For basic Windows operations, such as minimizing windows or using the scroll bars, refer to the MS Windows documentation.

---

In addition to the standard windows management methods, the following controls are added which allow the windows panes to be resized.

### Horizontal and Vertical Controls

Horizontal and vertical control icons are placed between adjacent panes. Clicking on an icon will expand the adjacent pane in the direction shown by the icon.



The size of panes can also be controlled by placing the cursor over the horizontal or vertical dividing bar so that it changes to a bidirectional arrow. The dividing bar can then be dragged to the required position, as shown in Figure 2–36.

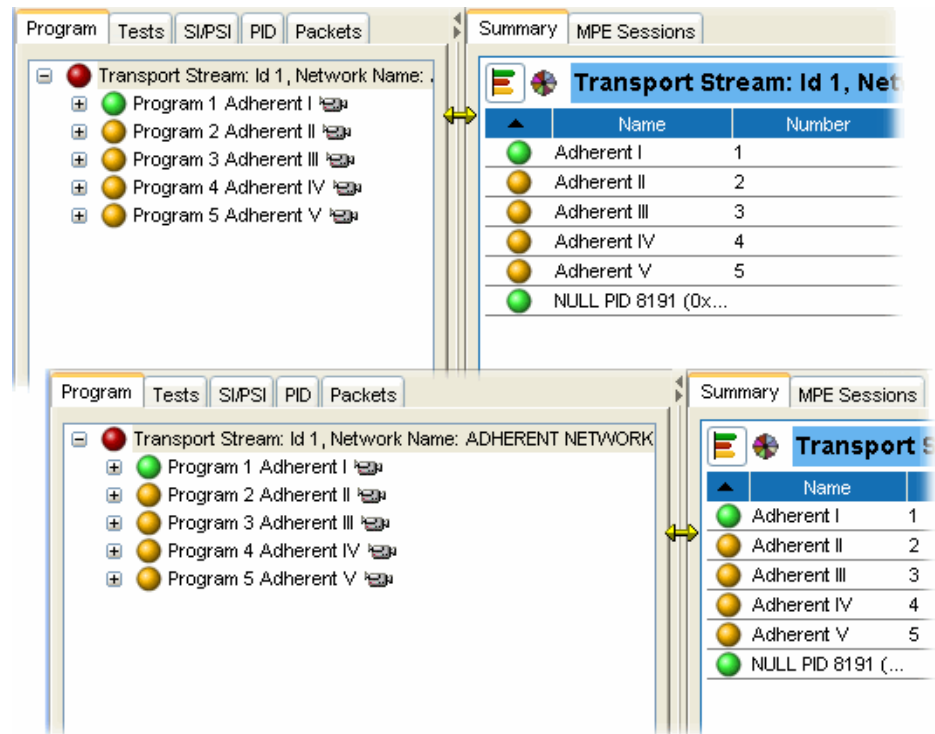

**Figure 2-36: Window size adjustments**

### Table Manipulation

In views such as the PID summary view, which take the form of a table, the columns can be sorted in ascending or descending order by clicking the section of the header bar on which the table is to be sorted. Similarly, column widths can be adjusted by dragging the column divider bar to the required column width.

## Icons

Icons are used in the TSCA to convey information about a node or function.



















Table 2-3 and Table 2-4 show the icons used in the TSCA with a brief description of each. Table 2-5 shows the icons used in the quick link section of shortcut menus.

---









**NOTE.** *The display of all icons is context-dependent. Not all icons will be visible in all views.*

---







**Table 2-3: Object identification icons**

Icon	Description
	Application Information Table (MHP)
	Audio
	Conditional Access PID
	Data stream
	Packet
	PCR
	Program
	Programs
	SI table
	SI table container
	SI tables
	Stream scrambled
	Subtitles
	Teletext
	Video
	Video + audio
	Closed caption - CC-EIA608
	Closed caption - CC-EIA708





**Table 2-4: Interface management icons**

Icon	Description
	Open transport stream
	View CaptureVu settings
	Capture analysis
	Bar chart
	Pie chart
	Link to
	Preferences
	Audible alarm
	CaptureVu breakpoint







**Graph management**

	Graph selection
	Zoom in
	Zoom out
	Show full dataset
	Hide/show limits
	Hide/show settling time indicators
	Rotate graph view





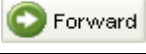

**Packet management**

	Remove all PID packets
	Remove PID packet
	Add PID packet
	PID packet group
	PID packet placeholder

**Table 2-4: Interface management icons (Cont.)**

Icon	Description
	Go to first packet
	Go to previous packet
	Go to next packet
	Go to last packet
	Open Go To Packet dialog box
<b>Action control</b>	
	Go to previous view
	Go to next view

**Table 2-5: Quick link icons**

Icon	Description
	Go to next red LED in current tree
	View this PID in PID tree
	View packets with this PID
	View packets in Packet tree
	View PCR graphs
	View this program's PMT in SI tree
	View this test in Tests tree



## Graph Management

A number of screens displaying graphs are available in the analyzer. The graphs are described in the relevant sections of this manual. This section describes the management of the graphs user interface.

Four categories of graph are available: those relating to PCR measurements, section timing, bit rates, and PTS (Presentation Time Stamps).

PCR measurement graphs include:

- PCR Drift
- PCR Inaccuracy
- PCR Arrival Interval
- PCR Frequency Offset
- PCR Jitter

Section timing graphs include:

- Section Repetition Interval
- Subtable Inter Section Gap
- Subtable Repetition Interval

For streams received over IP, the PIT (packet interarrival time) graph is available.

The graphs that can be displayed depend on the selection made in the navigation view. However, the menus and options for the graphs are similar and as described in the following pages.

## Measurement Background

Measurement points (2048 maximum) are held in a circular buffer.

**NOTE.** A circular buffer is an area of memory used to store a continuous stream of data by starting again at the beginning of the buffer after reaching the end.

A graph set for full display will show the current measurement points. During real-time analysis, the graph is constantly being filled (from the right to left), and measurements moving off the left side of the display are lost. The time scale (Y-axis) is started from zero each time that the node is accessed.

For some of the graphs, sufficient data must be gathered before meaningful results can be displayed. The phrase “Settling Time” will be displayed briefly in the graph area while the necessary data is gathered.

## Overview

Figure 2–37 shows a typical timing graph display. In this example, a PID carrying PCR has been selected, and two graphs are displayed: PTS Arrival Interval and PCR Arrival Interval.

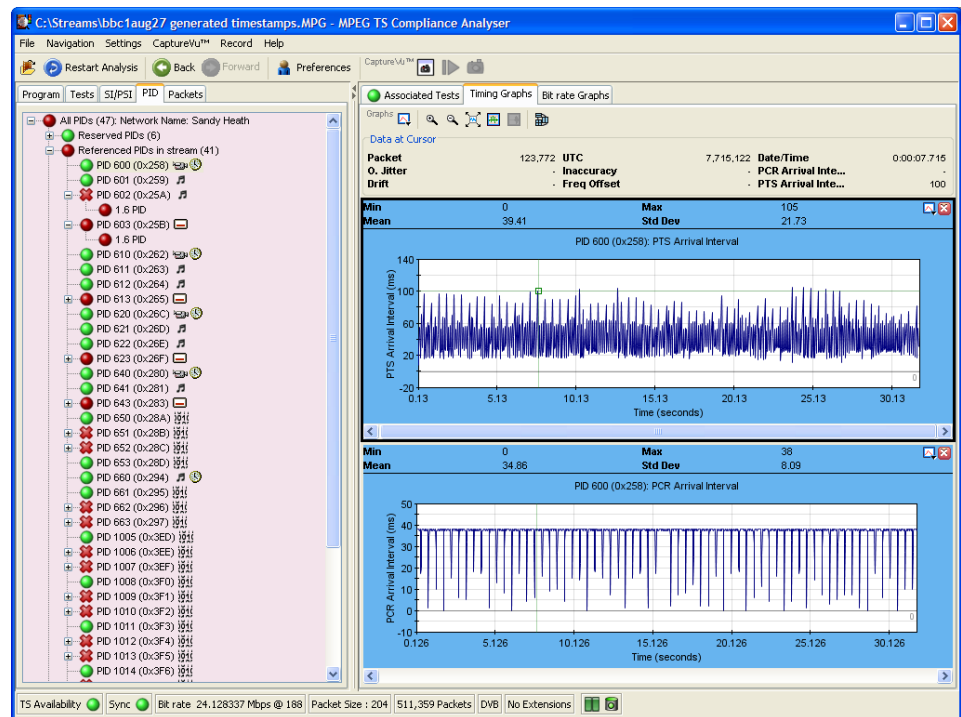
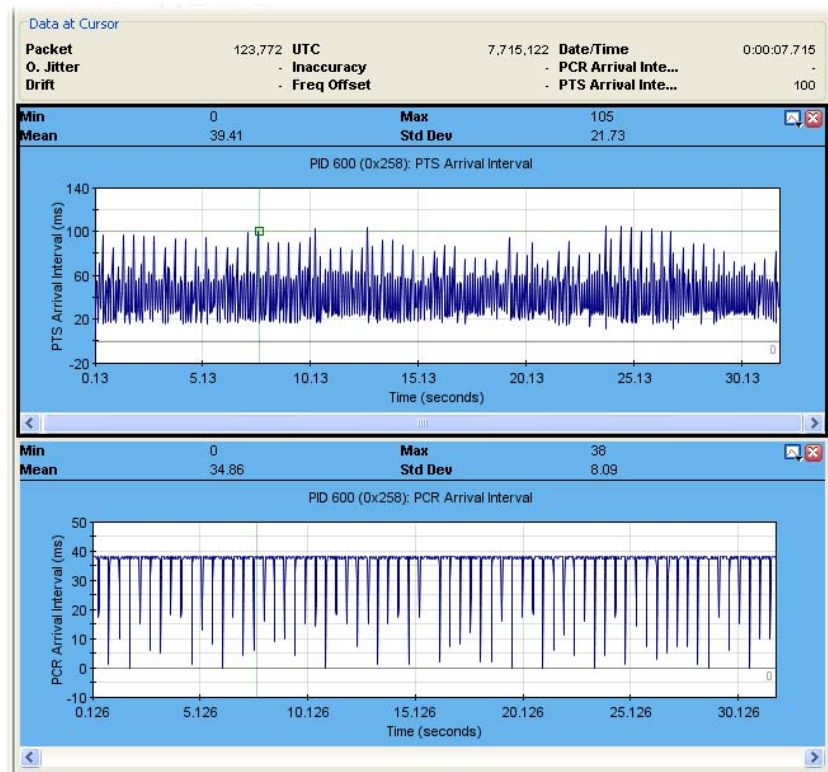

Figure 2–37: Timing graphs

Within the category, the X axis is common to the all graphs. A horizontal scroll bar allows you to select an area for inspection when the graph extends beyond the display area.

## Cursor Data and Control

A cursor can be displayed on the graphs allowing you to see accurate measurements in the adjacent data panel. You can place the cursor by clicking any data point on one of the graphs. Note that the cursor is displayed at the same point on all of the visible graphs.



**Figure 2–38: Graphs - cursor**

A tooltip is displayed when a point is selected giving the X and Y coordinates of the point; the values of these will vary depending on the graph.

Data associated with the selected point will also be displayed in the statistics panel (above the graphs). The displayed values (maximum, minimum, mean and standard deviation) are calculated for all of the data that is received while the navigator node is highlighted.

Similarly, data for all graphs is displayed in the Data at Cursor panel. A link to the associated packet is provided in the shortcut menu.

The cursor can be moved either by clicking a new position on the graph, or one point at a time by using the left or right controls on the keyboard.

**Graph Menu and Toolbar**

The Graph Toolbar allows you to select and control the available graphs (see Figure 2–39).

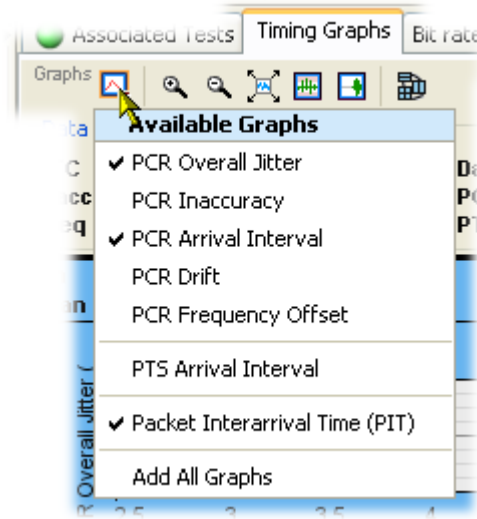

**Figure 2–39: Graph toolbar**

At the left end of the toolbar, a drop-down menu allows you to select which graphs are to be displayed. Only graphs for which data is available are listed. See *Timing Graphs*, page 2–97 for an explanation of the graphs.

The remaining graph controls are as follows:

Icon	Description
	Zoom in
	Zoom out
	Return graphs to full scale display (All graphs can be returned to full display by double-clicking anywhere in the graph display area.)
	Hide/show out-of-range indicators
	Hide/show settling time
	Rotate graph layout

The graph shortcut menu can be displayed by right-clicking anywhere in a graph display area. The options on the menu are applicable to only the graph from which the menu was selected.

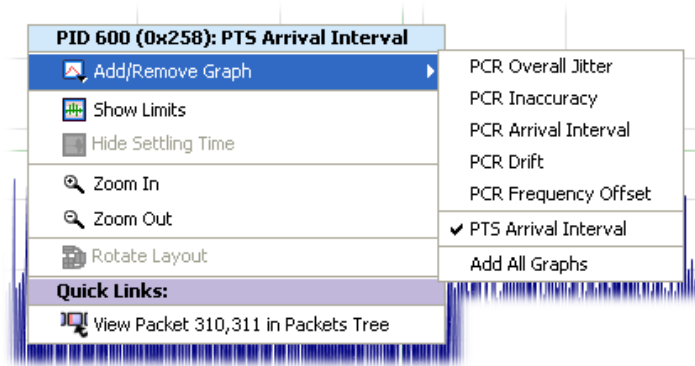

**Figure 2–40: Graph Shortcut menu**

The title bar displayed at the top of the menu shows which object the graph applies to (for example, PID 600).

### **Adding and Removing Graphs**

Graphs can be added by selecting them from the shortcut menu or from the drop-down menu either in the toolbar or from the top right corner of any displayed graph. All graphs can be opened by selecting Add All Graphs from the same menu. Each graph type can only be displayed once.

Graphs can be removed by clearing them from the shortcut menu or by clicking the close icon in the top right corner of the graph to be closed.

### **Out of Range Indicators**

Each graphed measurement has limits set either by default (derived from the stream interpretation standard) or as modified by the user (see *Parameter Edit*, page 2–104). If the limit is exceeded, an error is flagged.

Limits imposed by the test parameters can be displayed on a graph by clicking the Out of Range indicator icon (see Figure 2–41). In this example, the PTS Arrival Interval has been set at 700 ms. The area outside the limits is shaded (red). The Y axis is rescaled to show the maximum and minimum data points.

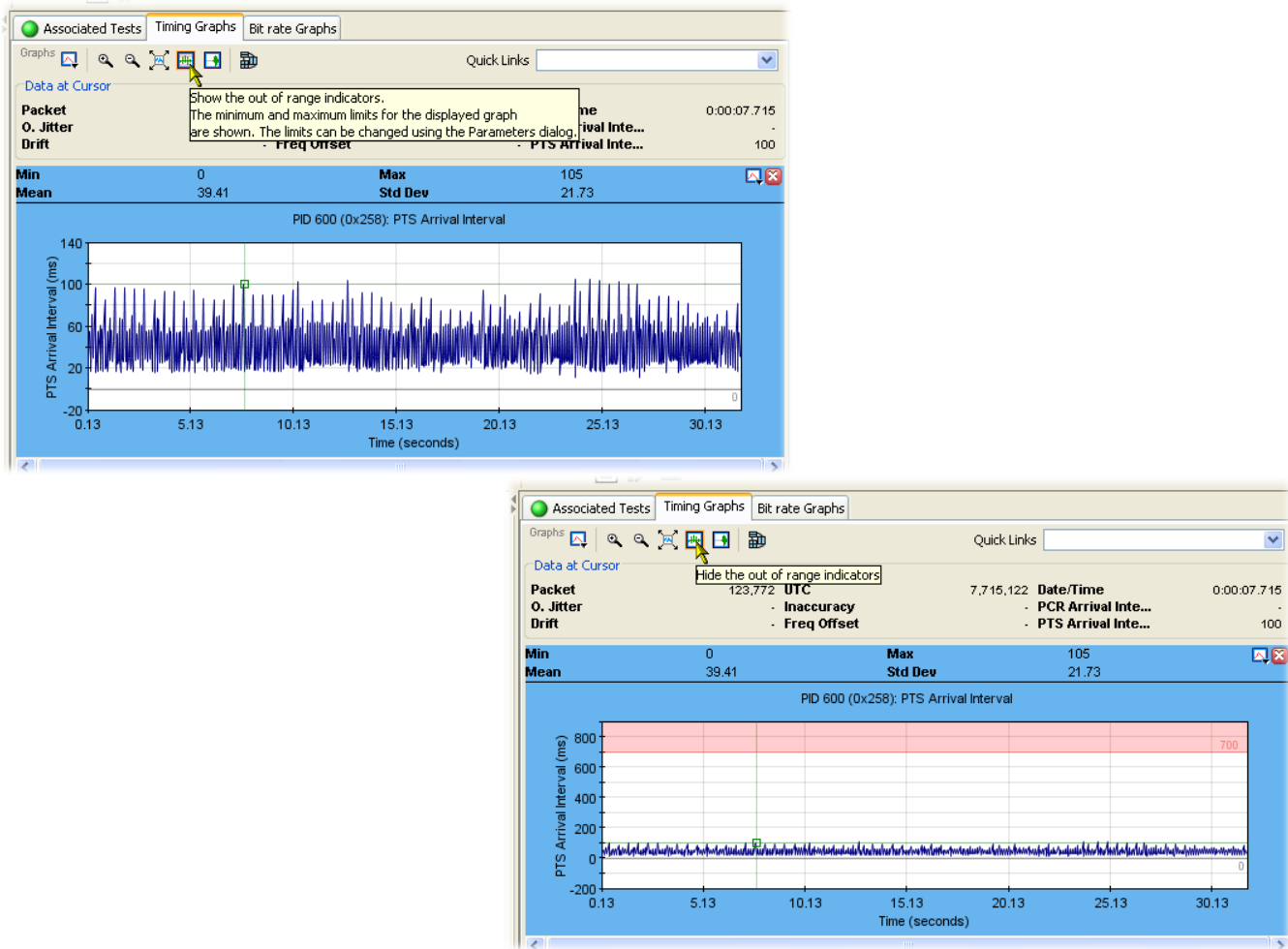

Figure 2-41: Out of range indicator

**Settling Time** Some of the graphs in the TSCA require a number of samples to be available before meaningful results can be displayed. The period during which sufficient samples are being gathered is referred to as the settling time. During this settling time, the graph is grayed out and displays the phrase “Settling Time”.

**Zoom Feature** You can zoom graphs in and out using the controls on the menu bar or from the Graph Menu. An area of a graph can also be expanded by holding the right mouse button and dragging a rectangle around the area of interest.

Zooming (in or out) is centered on the middle point of the graph, irrespective of the cursor position. Both axes are expanded/contracted to accommodate the revised display. The graph is expanded or contracted by 25% of the displayed

area each time that the control is used. Double-clicking on a graph rescales the axes to show the complete plotted data set.

If you hold the shift key when the zoom control is clicked, the Y axis is locked while the X axis is expanded or contracted.

If you hold the control key when the zoom control is clicked, the X axis locked while the Y axis is expanded or contracted.

During real-time analysis, expanding (zooming in) an area of a graph generates a static snapshot of the graph. Because of the way that the measurements are stored in the circular buffer, the display will eventually clear. The only way to redisplay the graph is to return to full-scale display.

## Timing Graphs

Table 2–6 shows the timing graphs that are available for PIDs carrying PCR and PTSs. If a PCR PID is also carrying time stamp information, the full set of graphs will be available.

The graphs available will depend on whether the PID is carrying PCR and/or time stamp (TS) information.

**Table 2-6: Timing measurement graphs**

Graph Type	PID + PCR	PID + PCR + TS
PCR Inaccuracy	✓	✓
PCR Arrival Interval	✓	✓
PCR Drift Rate	-	✓
PCR Frequency Offset	-	✓
PCR Overall Jitter	-	✓
PTS Arrival Interval	-	✓

Descriptions follow of each of the measurements. Adjustments can be made to each of the measurement parameters.

If the interval exceeds the limits displayed on the screen, the scale is adjusted automatically as necessary to include the maximum displayed values.

---

**NOTE.** *As with other parameter value adjustments, it is important to note where the adjustment is being made from. If the adjustment is made with a test node highlighted, all PIDs will be measured against that value. If the adjustment is made with a PID highlighted, only that PID will be measured against the modified value.*

---

**PCR Inaccuracy  
(PCR\_AC)**

The PCR Inaccuracy graph shows the difference between the actual and expected values for each PCR on the Y-axis. Expected PCR values are calculated from the byte index of the PCR.

The default limits are set to  $\pm 500$  ns.

The Maximum PCR Accuracy Error limit can be adjusted by modifying the Max PCR accuracy error.

**PCR Arrival Interval**

The PCR Arrival Interval graph provides a display of the time interval between successive PCRs, during the last 256 PCRs. The interval is displayed on the Y-axis. The default limit (Maximum Repetition Period set in ETR 101 290 test 2.3) is 40 ms.

The PCR Maximum Repetition Interval limit can be adjusted by modifying the PCR max repetition interval.

**PCR Drift Rate (PCR\_DR)**

This Drift Rate graph shows the rate of change of PCR Frequency Offset, which is often very small. It is calculated using PCR Frequency Offset measurements.

The maximum PCR Drift Rate limit can be adjusted by modifying the Max PCR frequency drift rate parameter.

**PCR Frequency Offset  
(PCR\_FO)**

The Frequency Offset graph shows the difference between the program clock frequency and the nominal clock frequency (measured against a reference that is not PCR or transport stream derived).

PCR Frequency Offset is a measurement of the error in the PCR frequency from the specified 27 MHz; the MPEG specification sets the limits at  $\pm 810$  Hz.

The Maximum PCR Frequency Offset limit can be adjusted by modifying the “Max PCR frequency offset” parameter.

**PCR Overall Jitter  
(PCR\_OJ)**

The PCR Overall Jitter graph shows the time interval between the actual value of the PCR and its expected value based on its arrival time.

The Maximum PCR Accuracy Error limit can be adjusted by modifying the Max PCR overall jitter parameter.



## MTS400 PCR Measurements and Settling Time

**Demarcation Frequency.** The PCR measurements provided by the MTS400 Transport Stream Compliance Analyzer are defined by TR 101 290. Appendix I of TR 101 290 describes the measurements in detail, and also introduces the concept of the “demarcation frequency” at which PCR errors are separated into drift errors or jitter errors. Errors below the demarcation frequency are measured as drift, while errors above that frequency are measured as jitter.

TR 101 290 also defines three standard demarcation frequencies, MGF1 (10 mHz), MGF2 (100 mHz), and MGF3 (1000 mHz), at which the PCR measurements can be made, and provides for a user-definable demarcation frequency, MGF4.

From the menu bar, select Settings > PCR filter settings... to open the PCR Drift/Jitter Demarcation Filters dialog box (see Figure 2–42). Any PCR error below the low-pass filter cutoff frequency will be measured as drift; any error above the high-pass filter cutoff will be measured as jitter.

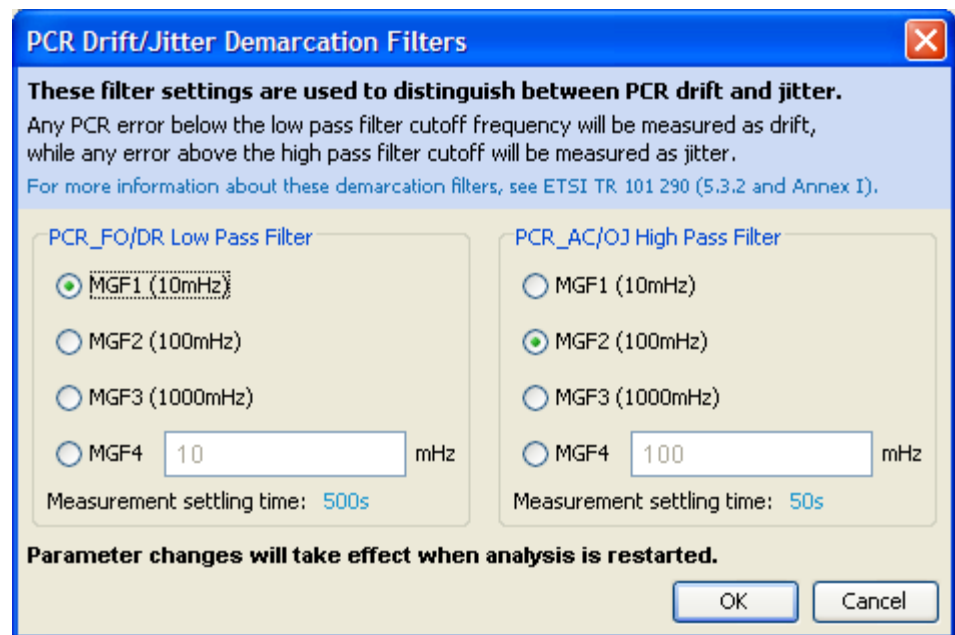

**Figure 2–42: PCR Drift/Jitter Demarcation Filters dialog box**

The filters can be set to any of the standard MGF profiles, or a user desired cut-off frequency, by selecting MGF4 and entering a value between 1 mHz and 10000 mHz (10 Hz).

Alternatively, these filter values can be changed by selecting Settings > Parameters... from the menu bar, scrolling to the appropriate parameters, and making the required changes.

Description	Value	Units	Min	Max	Nominal
PCR_FO/DR low-pass filter cutoff frequency	10	mHz	1	10000	10
PCR_OJ/AC high-pass filter cutoff (0 for same...	100	mHz	0	10000	100
PID bit rate bin count for service log	10	integer > 0	1	100	10

**Figure 2-43: PCR parameters - Filter settings**

Please note that the TR 101 290 drift limit of  $\pm 75$  mHz/s is only defined at a demarcation frequency of 10 mHz. As the low-pass filter frequency is increased above that value, more of the PCR jitter will be measured as drift, and so the measured drift values will increase. If you are attempting to check that your source PCR clock is compliant with the TR 101 290 limits, the low-pass filter cut-off frequency should be set to 10 mHz.

**Settling Time.** All of the PCR measurements that depend on demarcation filters have a settling time. The measurements will not return valid values before this time elapses. The settling time is indicated on the PCR graphs in the TSCA.

This settling time is inversely proportional to the cut-off frequency of the demarcation filter. This means that there is a trade-off between reducing the filter frequency to improve drift measurement accuracy and increasing the time it takes to obtain any drift measurements at all.

**Table 2-7: PCR settling times**

Filter cut-off	Settling time	TR101-290 profile	Comments
10 mHz	500 s	MGF1	TSCA default for PCR_FO/DR low-pass filter cut-off; drift limit of $\pm 75$ mHz/s is only applicable at this level
100 mHz	50 s	MGF2	TSCA default for PCR_OJ/AC high-pass filter cut-off.
1000 mHz (1Hz)	5 s	MGF3	-
1 mHz - 10,000 mHz	5000 s – 0.5 s	MGF4	User-defined profile

For more information about PCR measurements, please read the *PCR Measurements Primer*, available on the Tektronix Web site ([www.tektronix.com](http://www.tektronix.com)).

## PTS Graph

Presentation Time Stamps (PTS) indicate the exact moment where a video frame or an audio frame has to be decoded or presented to the user respectively. The PTS graphs show the PTS arrival intervals. (See also *Graph Management*, page 2–91.)

## Bit Rate Graphs

Bit rate graphs are available on program and PID nodes. (See also *Graph Management*, page 2–91.)

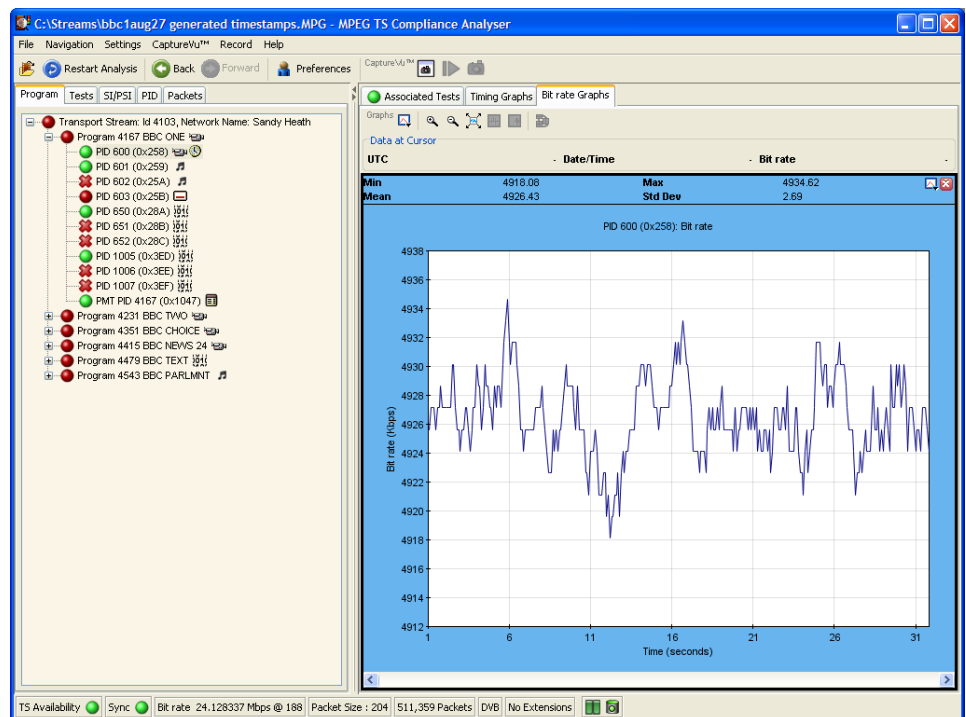

Figure 2–44: Bit rate graph

## PIT Graph

The PIT Graph displays the mean interarrival time of IP packets. This can be viewed from the Transport Stream node in the Program view. It can also be viewed alongside other timing graphs for PIDs with PTS and/or PCR information. This can help you coordinate apparent problems with PCR and PTS timing with IP packet timing.

## Now Playing Views

The Now Playing tab provides thumbnails of the video content at the transport stream and program node levels. Icons at the top right of the now playing screen provide three levels of detail and layout of the thumbnails. Thumbnails, Summary, and Details. Figure 2–45 to Figure 2–47 illustrate the level of detail provided by each icon.

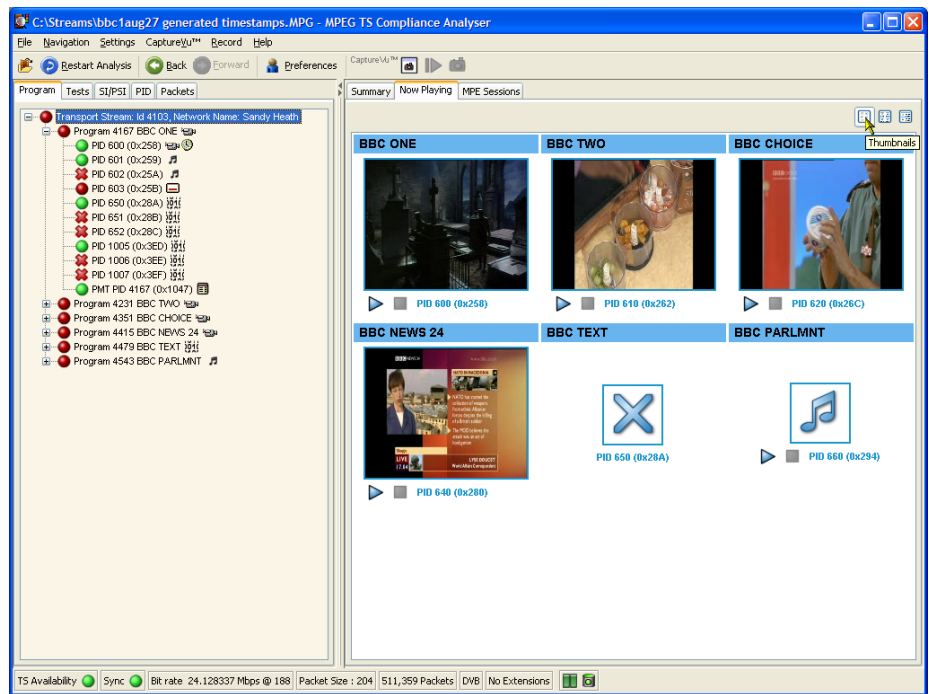

Figure 2–45: Now Playing - Thumbnail view

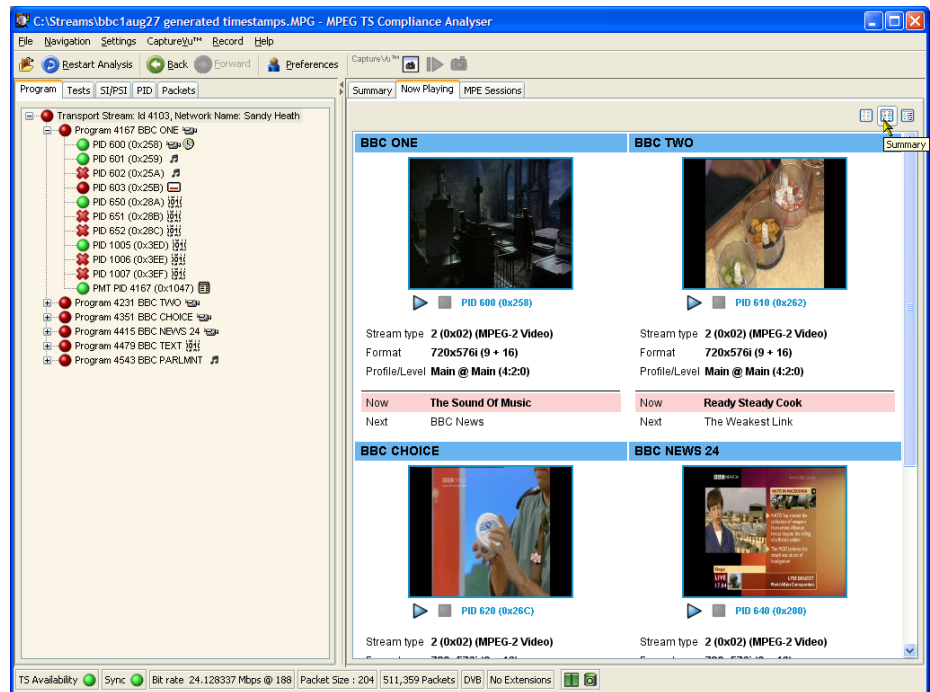

Figure 2-46: Now Playing - Summary view

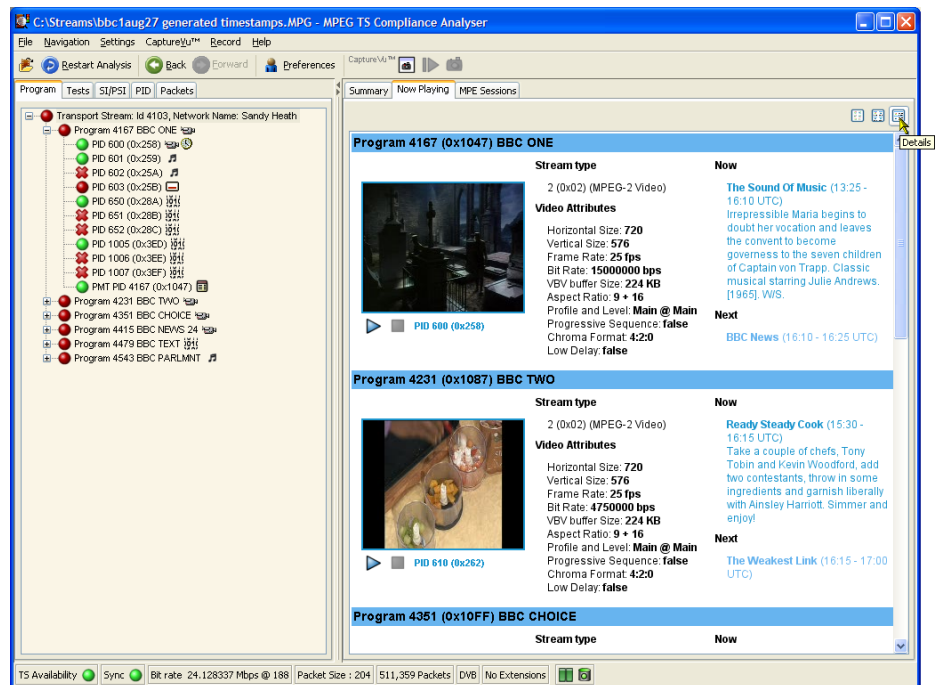

Figure 2-47: Now Playing - Detail view

## Parameter Edit

Each of the error states displayed on the user interface are the result of making one or more measurements or tests on the analyzed transport stream. The displayed tests are derived from the selected interpretation standard. Additional proprietary tests are also included.

Some measurements and tests translate directly to an error state, and others are the result of a combination of tests. For many of the tests, you can affect the result by varying parameters that influence the test result, for example, maximum and minimum bit rate values, although the test result may not then conform to the chosen interpretation standard.

Figure 2–48 shows the parameters that are available for the ETR 101 290 test 2.5. Figure 2–49 shows the parameters that are available for a single PID under ETR 101 290 test 2.5. Not all parameters applied to a test are necessarily applied to a PID.

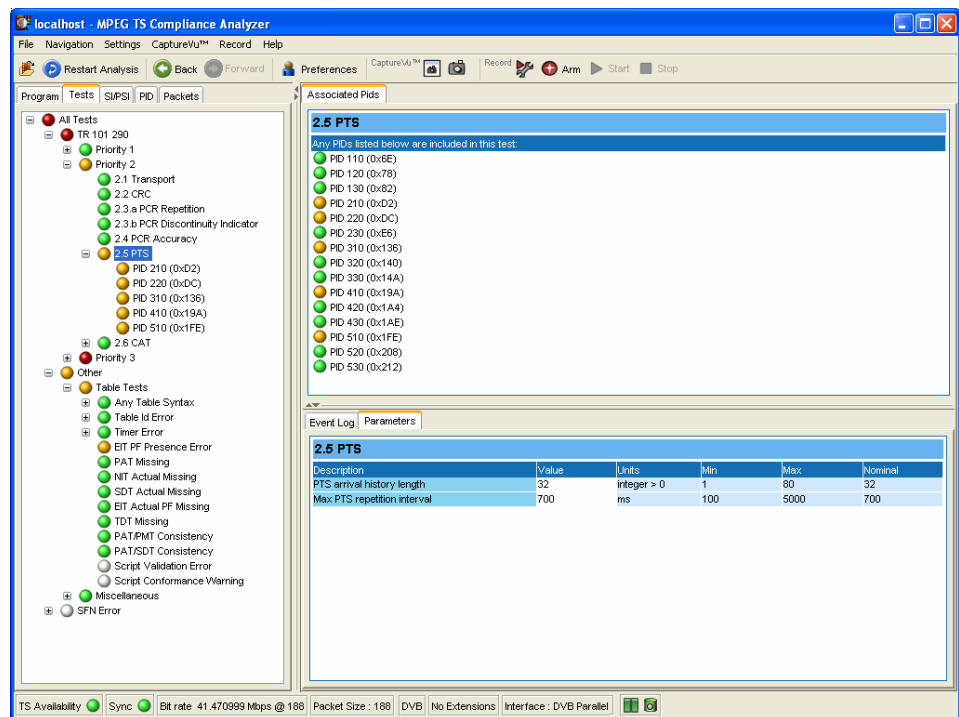
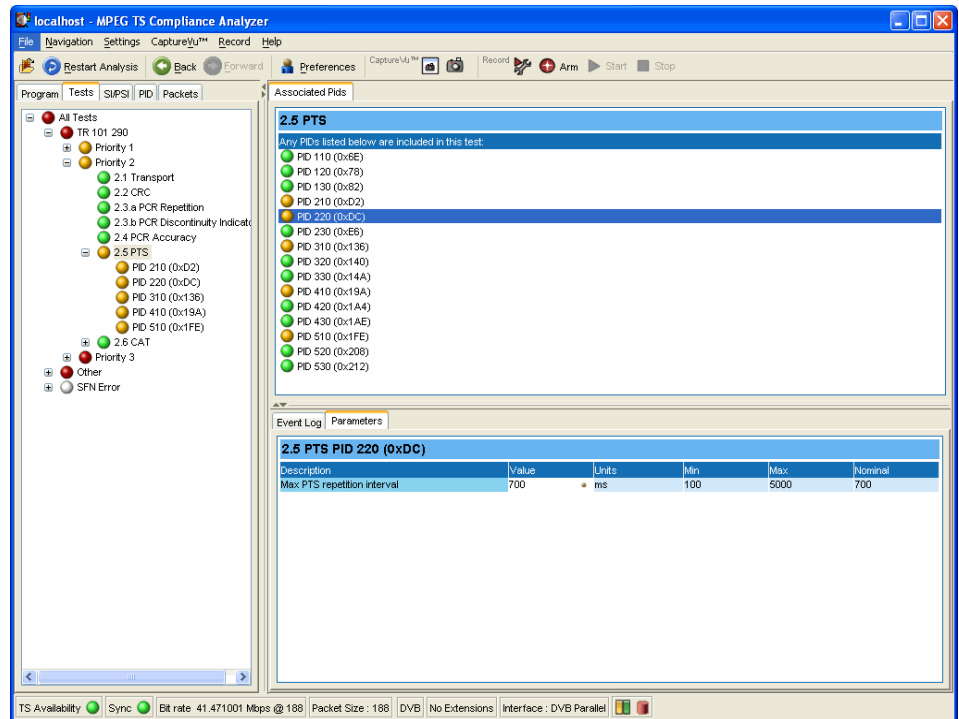

Figure 2–48: Test parameters



**Figure 2–49: PID test parameters**

Each test parameter entry includes the following fields:

- Description of the parameter.
- Value - the current setting. If the setting is the same as the nominal value, an icon will also be displayed in this field.
- Units in which the measurement is made.
- Maximum and minimum values. These are the maximum and minimum values recommended by the selected standard.
- Nominal value. This is the value or setting recommended by the selected interpretation standard.

It is important to understand the difference between default and nominal values.

If a parameter value is set for a test, it becomes the default value for the test and for all PIDs subject to that test. PIDs using the default value will have a bullet icon displayed in the Value field (see Figure 2–50).



**Figure 2–50: Parameter value - default icon**

However, you can also set individual PID parameter values. The value set is applied to only that PID, not to the other PIDs using the same test or the test default value.

The nominal value is provided by the interpretation standard; it cannot be changed using the user interface.

### **Changing a Test Parameter Value**

To change the value of a test parameter:

1. Click in the Value field.
2. Enter the required value.
3. Press Enter.

---

**NOTE.** For a new value to take effect during deferred analysis, the stream must be closed. Select Restart Analysis to open and reanalyze the stream.

---



## Access to All Parameters

All parameters are accessible from the Parameters menu option (Settings > Parameters...). Parameters are initially listed in alphabetical order. To quickly search for a parameter, enter text in the search field, for example 'BER'. Only parameters containing the entered text in their description will be displayed. You can clear search text by selecting the button adjacent to the search field.

Parameter values can be changed in the same way as individual parameters. Changes made to values in this dialog box are also applied to the individual PID parameters, since changes made here become the default value for the parameter.

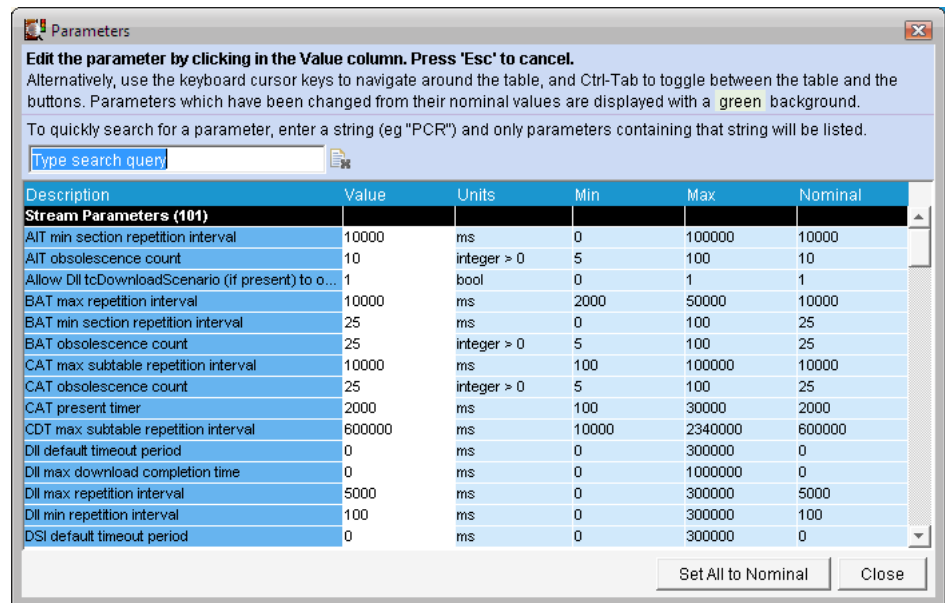

Select the Set All to Nominal button to return all parameter values to their factory settings. During deferred analysis, the current stream will need to be closed and reopened (reanalyzed) for the new parameter settings to take effect.

## Event Log

The event log displays a history of events related to a selected item. When no log is available, the message "No log entries were found" is displayed. In a log, events are placed in chronological order (with the most recent at the top).

Event log displays are context-dependent; the view and object that is currently selected will dictate the content of the associated log. For example, with the transport stream node selected in the Programs navigation view, the associated event log displays all events. Similarly, with a single PID selected, the associated event log only displays events relevant to that PID. Exported logs are similarly context-dependent; only currently displayed events will be exported.

**Event Log Control**

The event log will normally display the most recent event at the top of the log. Past events will be scrolled down the screen; not all of these event entries can be viewed on a single screen, even in a maximized Log View window.

If events are constantly being generated, an event entry may pass out of view before you have a chance to examine it.



However, if you scroll down to view a past event, the viewing window will remain fixed on that entry, even though events entries are still being added at the top of the log view. This is evident by the scroll box continuing to advance towards the bottom of the screen.

The event entry being viewed will eventually move to the bottom of the event log. At this point the entry will be lost, the view will return to the most recent entries at the top of the screen, and automatic scrolling will recommence.

**Event Log Pinning**

Another way of viewing a single event in a stream of log events is by pinning the log. By pinning the log, you are taking a snapshot of the log at a particular moment in time; you can then move up and down the pinned log as required. Newly generated events will continue to be generated but will not be displayed until the log is unpinned.

You can pin the log by selecting the Pin icon or Pin Log from the shortcut menu.

	Shows that the log is not pinned Select to pin the log
	Shows that the log is pinned Select to unpin the log

When the log is pinned, it is displayed against a blue background and the pin icon is changed.

Note that pinning the log may take a few seconds. The whole log is saved, up to 1000 entries.

The log will remain pinned until you select the Pin icon or display another TSCA view.

## Exporting the Event Log

You can export the log (pinned or unpinned) in either XML or CSV format.

You can export the log by selecting the Export icon or Export Log from the shortcut menu.



Select the format in which the log file is to be saved, either xml or csv, and a location for the file.

## Color-Coding Events

Specific event types can be color-coded in the display to allow them to be identified more easily (as shown in Figure 2–51). Color-coding can be done from any event log display. The color-coding dialog box is available from the event log shortcut menu.

The screenshot shows a window titled "Event Log" with a tab for "TR 101 290". Below the tab is a header "Transport Stream: Id 1, Network Name: ADHERENT NETWORK". The main area contains a table with columns: Status, Date, Time, Packet, and Description. The table lists several events, with three rows highlighted in blue to indicate color-coding.

Status	Date	Time	Packet	Description
●	28-Feb-2005	14:42:49.784	14607847	TR 101 290 error 2.5 (PTS_error): Timer pid 220 end, duration 48ms
●	28-Feb-2005	14:42:49.736	14606523	TR 101 290 error 2.5 (PTS_error): Timer pid 220 start
●	28-Feb-2005	14:42:45.000	-	TR 101 290 error 3.6.c (EIT_PF_error): Id: 0x4e, Extended Id: 0x1
●	28-Feb-2005	14:41:54.000	-	TR 101 290 error 3.6.c (EIT_PF_error): Id: 0x4e, Extended Id: 0x1
●	28-Feb-2005	14:41:50.376	12969738	TR 101 290 error 2.5 (PTS_error): Timer pid 310 end, duration 40ms
●	28-Feb-2005	14:41:50.336	12968636	TR 101 290 error 2.5 (PTS_error): Timer pid 310 start
●	28-Feb-2005	14:41:50.261	12966569	TR 101 290 error 2.5 (PTS_error): Timer pid 410 end, duration 40ms
●	28-Feb-2005	14:41:50.251	12966294	TR 101 290 error 2.5 (PTS_error): Timer pid 210 end, duration 40ms
●	28-Feb-2005	14:41:50.221	12965466	TR 101 290 error 2.5 (PTS_error): Timer pid 410 start
●	28-Feb-2005	14:41:50.211	12965192	TR 101 290 error 2.5 (PTS_error): Timer pid 210 start
●	28-Feb-2005	14:41:50.146	12963399	TR 101 290 error 2.5 (PTS_error): Timer pid 510 end, duration 40ms
●	28-Feb-2005	14:41:50.106	12962296	TR 101 290 error 2.5 (PTS_error): Timer pid 510 start

Figure 2–51: Event log - color coding

1. Highlight the event type and select Color from the shortcut menu (see Figure 2–52). Figure 2–53 shows the Color dialog box.

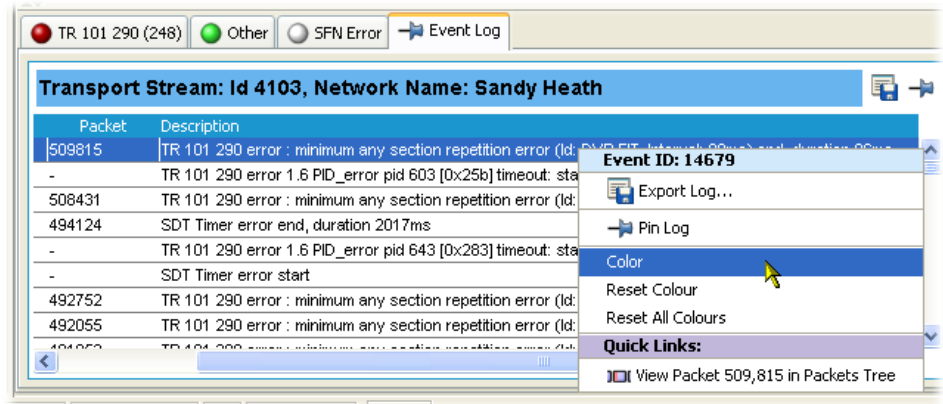

Figure 2–52: Event log - shortcut menu - color

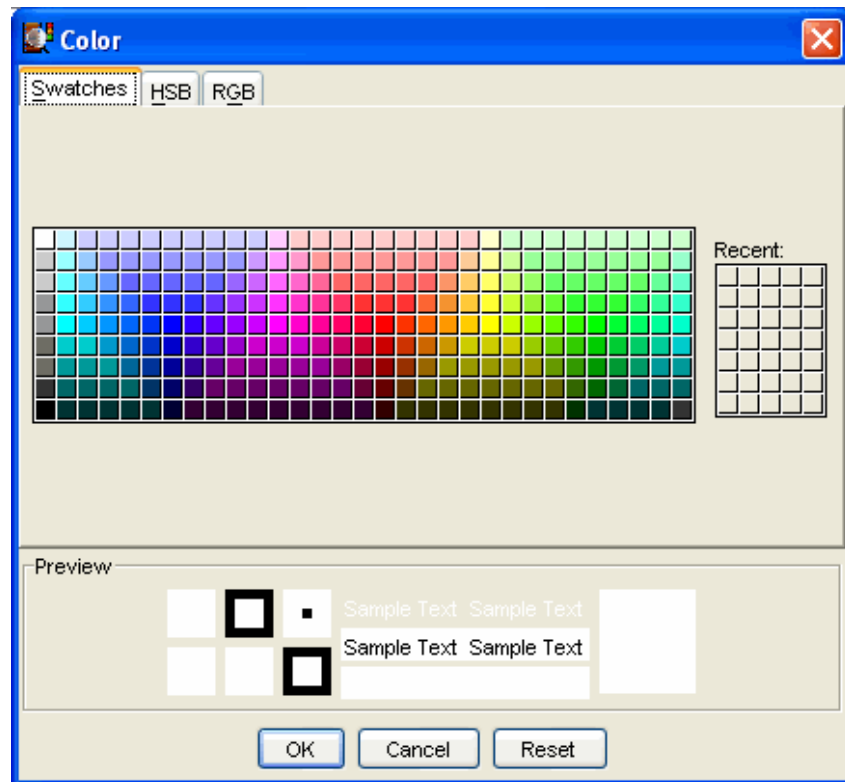

Figure 2–53: Event log - color dialog boxes

2. Select the primary display color.

The color can be specified from the Swatches tab. It can also be specified in HSB (Hue, Saturation, Brightness) or RGB (Red, Green, Blue) terms by selecting the appropriate tab and entering the required values.

3. Select OK. All events of the same type are now highlighted in the selected color.

The color-coding on a single event type can be removed by selecting Reset Color from the Event Log shortcut menu. Color-coding can be removed from all event types by selecting Reset All Colors from the shortcut menu.

## Bit Rates

In a stream, bit rates are calculated and displayed for the following:

- Transport stream
- Programs
- PIDs

The display choices (bar chart or pie chart) and management of the display are similar for each type.

Select the appropriate icon to switch charts:



**Figure 2-54: Bit Rate display selection**

### Bar Charts

The following information is included with the bit rate bar charts:

- Error status (LED)
- Object name (Program or PID name)
- Stream type (PIDs only)
- Bit rate bar including change bars and limit markers, where relevant
- Bit rate statistics (including the current bit rate, the bit rate expressed as a percentage of the overall bit rate, and the maximum and minimum values reached during analysis).

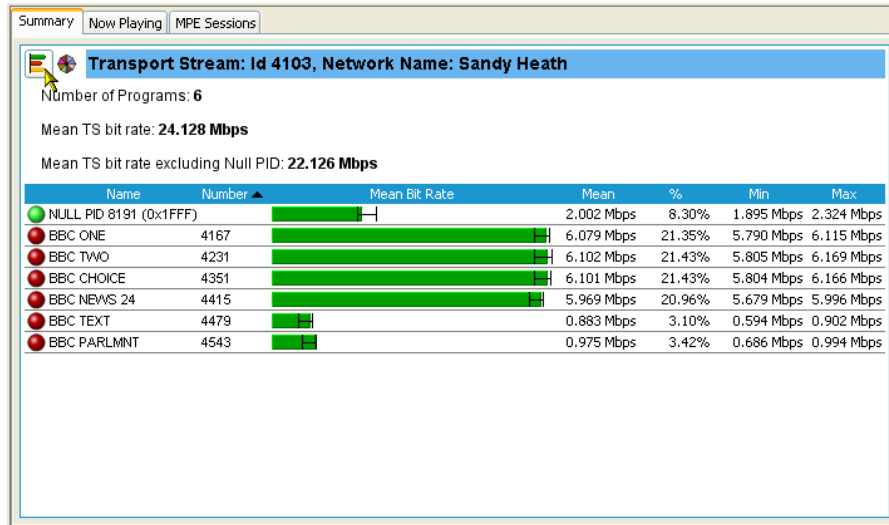

Figure 2-55: Bar chart

The bit rate bars are scaled so that all bars are displayed relative to the one with the highest bit rate.

Column widths can be adjusted by dragging the line dividing the title bar to the left or right with the mouse.

**Error Indication**

Two levels of error status are displayed in each row. The error status LED shows the test status of the element, for example, a program. The color of the bit rate bar indicates the bit rate status and whether the rate has exceeded the limits set.

**Range Bar**

A range bar indicates the variation of bit rate in each program or PID. The ends of the bar show the maximum and minimum values of the bit rate since monitoring started.

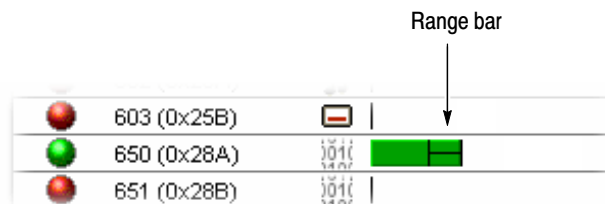

## Bit Rate Limits

Bit rate limits can be set on a program or PID bar. An error will be indicated when the bit rate exceeds the limits set.

You can highlight the program or PID and select Set Bit Rate Limits... from the shortcut menu.

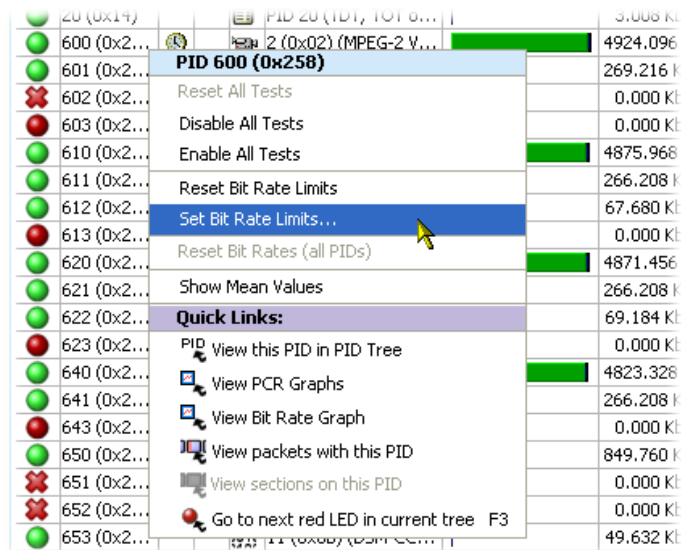

The Set Bit Rate Limits dialog box is opened:

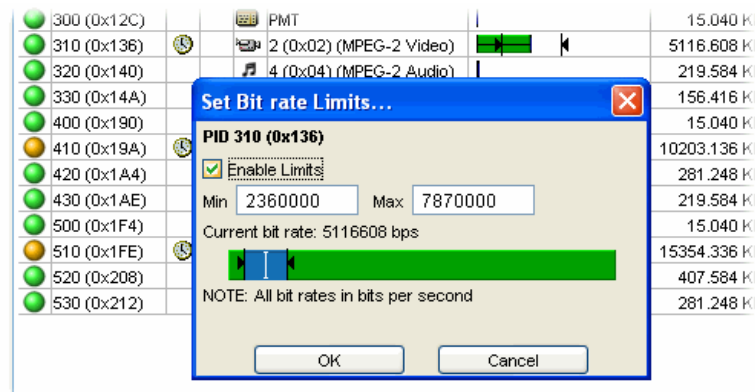

You can enable the limits by selecting the Enable Limits checkbox and enter the required values. The cursor in the bar indicates the current bit rate. The limits can also be changed by dragging the limit icons in the dialog box to the required positions. The color of the overall bar in the limits dialog box indicates whether the current bit rate is within the proposed limits. Select OK to close the dialog box. The limit icons will now be displayed on the bit rate bar. The scaling of all bars is recalculated to ensure that the maximum limit is displayed.

During deferred analysis, the stream must be closed and reopened to reanalyze it and view the effects of the limits. Real-time limits take effect immediately. Limit values are retained when the application is closed. Limits set for specific PIDs will be applied (to a PID with the same number) irrespective of the stream being analyzed.

Setting (and resetting) the bit rate limits for programs and PIDs will automatically update the Program Occupancy and PID Occupancy tests. To change the transport stream bit rate limits, the parameters must be altered directly in the Transport Stream Occupancy test. This can be found under the Other tab in the Tests view.

The Bit Rate Limits of *all* programs in a stream can be disabled and reset by selecting the Clear Limits button at the top of the Programs screen.

### Pie Charts

The pie chart shows similar information as the bar chart.

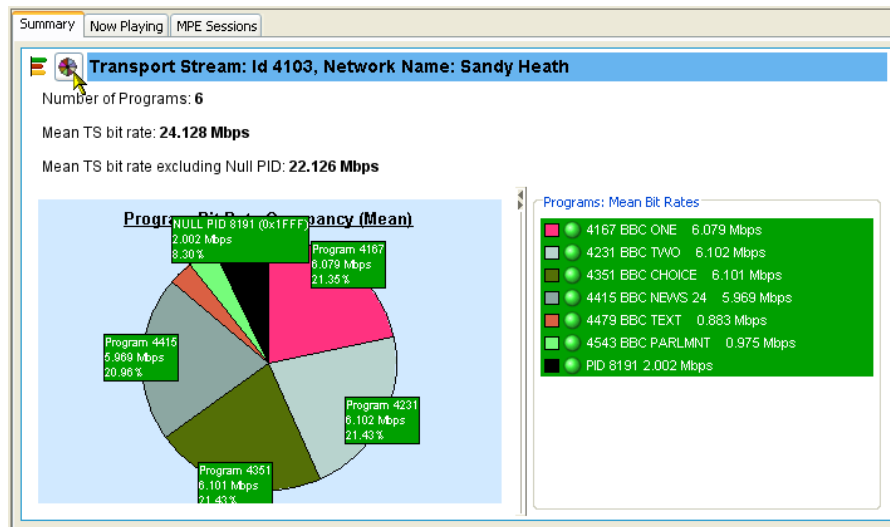

Figure 2-56: Pie chart

The pie chart view is divided into two panes. The left pane shows the pie chart, and the right pane provides a list of the component programs. Each program is color-coded. Related information given includes the overall program status (icon), the program name and number, and the bit rate (bps). The bit rate expressed as a percentage of the overall bit rate is displayed in the segment labels. The maximum and minimum values are not shown.

If a segment label is hidden at the edge of the window, click on a segment to display the label in full.



## EPG View

An electronic program guide (EPG), where present, is a schedule of events, and programs, that are or will be available on each service. A short summary or commentary for each event may also be included. Events for services which are actually carried in the stream are referred to as “actual” and as “present” or as “following” (labeled as “EIT actual p/f” in the navigation view).

A transport stream may also carry EPG information for other network services, referred to as “other” (labeled as “EIT other p/f” in the navigation view).

---

**NOTE.** *The examples shown in the figures in this section are of DVB transport streams. The construction of SI and node names in ATSC and ISDB streams differ.*

---

The EPG node in the navigation view contains and displays all of the program information carried in the transport stream.

The content of the Detail view will depend on the currently highlighted EPG table node. Nodes representing an individual table or subtable will offer the usual Summary, Section, and SI Repetition graph detail views. However, the higher nodes will display the programming information graphically as shown in Figure 2–57.

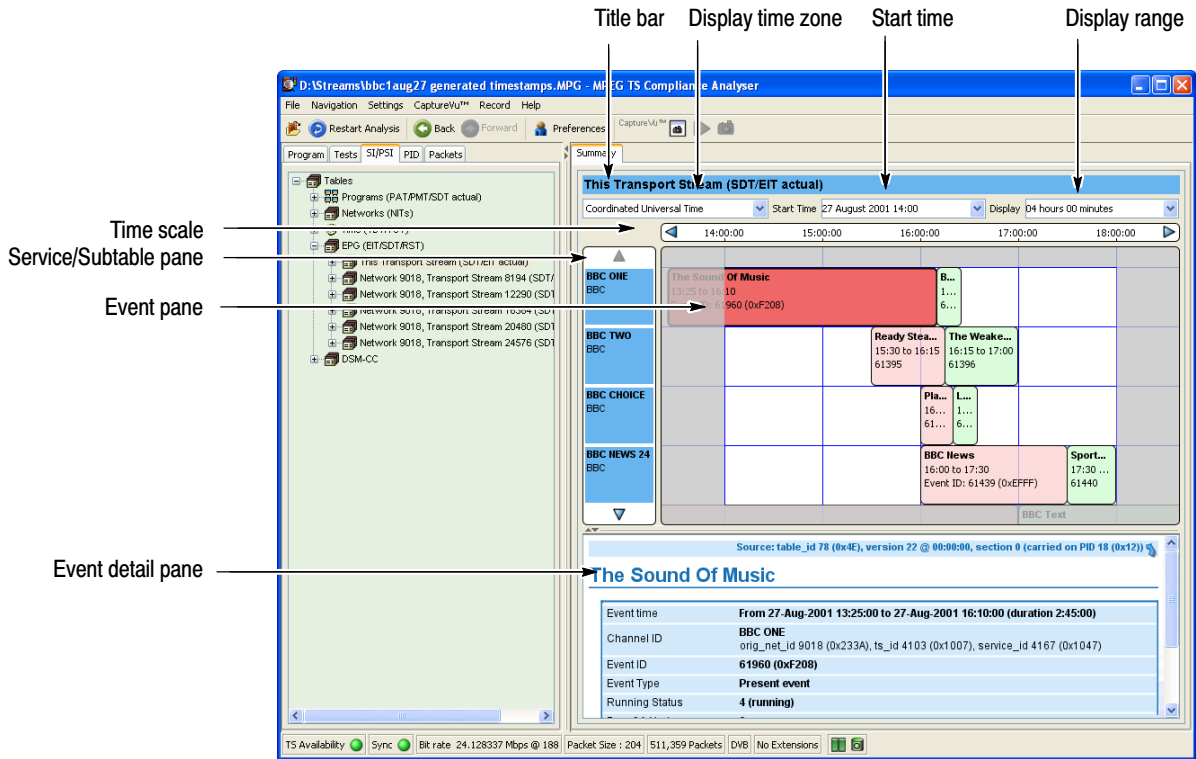

Figure 2-57: EPG Summary view

## EPG Node Summary



**Figure 2–58: EPG nodes**

For each node type, the detail view shows the following information:

<b>EPG node:</b>	Links to the EPG information for all the transport streams described in this stream.
<b>Transport stream summary nodes:</b>	Graphical view of the events identified in the service(s) belonging to a specific transport stream.
<b>SDT nodes (Service Description Table):</b>	Links to services identified in the SI for a specific transport stream.
<b>Service summary nodes:</b>	Graphical view of the events identified in the service.
<b>EIT nodes:</b>	Detailed view of event information for a single EIT subtable.

**EPG Summary View**

The screen elements highlighted in Figure 2–57 are described below:

**Title bar:** Displays the title of the currently highlighted service or transport stream.

**Displayed Time Zone:** Select the required time zone from the drop-down list. The time scale will change accordingly. The time zone may be derived either from the transport stream, UTC (Co-ordinated Universal Time), or local time (as set on the host computer).

**Start Time:** Shows the event panel start time and date. Other dates can be selected from the drop-down calendar, and the display will scroll to the selected date.

In deferred mode, the initial date and time will be dictated by the information found in the stream. If the selected date is beyond that held in the EPG information, the date will be automatically set to the last date held in the information.

Note that in real-time mode, this information is updated regularly.

**Display:** Shows the extent of the event panel. More detail can be displayed by choosing a shorter time period. Select the required range from the drop-down list.

**Timescale:** Shows the start and end time of the current event panel. The range is dictated by the Display field selection.

**Service/Subtable panel:** When a transport stream EPG is selected, this panel shows the names of the services currently displayed in the event panel. The displayed services will vary depending on which node is selected in the navigation view.

**Event panel:** This panel shows the events for one or more services, depending on the selected node. Individual events are color-coded and shown as blocks; each block (and its associated tooltip) displays event information that is extracted from the EIT. When a block is selected, the complete event information is shown in the event detail panel, including a link to the section carrying the information.

Events are color-coded as follows:

- Red: Present event
- Green: Following event
- Blue: Schedule event
- Yellow: (ISDB only) After event

**Event detail panel:** Shows details of the selected event. The details are contained in the EIT (event information table).

## MPE Views

Multi-Protocol Encapsulation (MPE) provides a mechanism for transporting data network protocols on top of the MPEG-2 transport streams in DVB networks. MPE data has been optimized to carry the internet protocol (IP). MPE covers unicast (datagrams targeted to a single receiver), multicast (datagrams targeted to a group of receivers), and broadcast (datagrams targeted to all receivers). The 48 bit MAC (Media Access Control) addresses are used for addressing receivers.

The MPE views display the MPE data flow currently available in the stream.

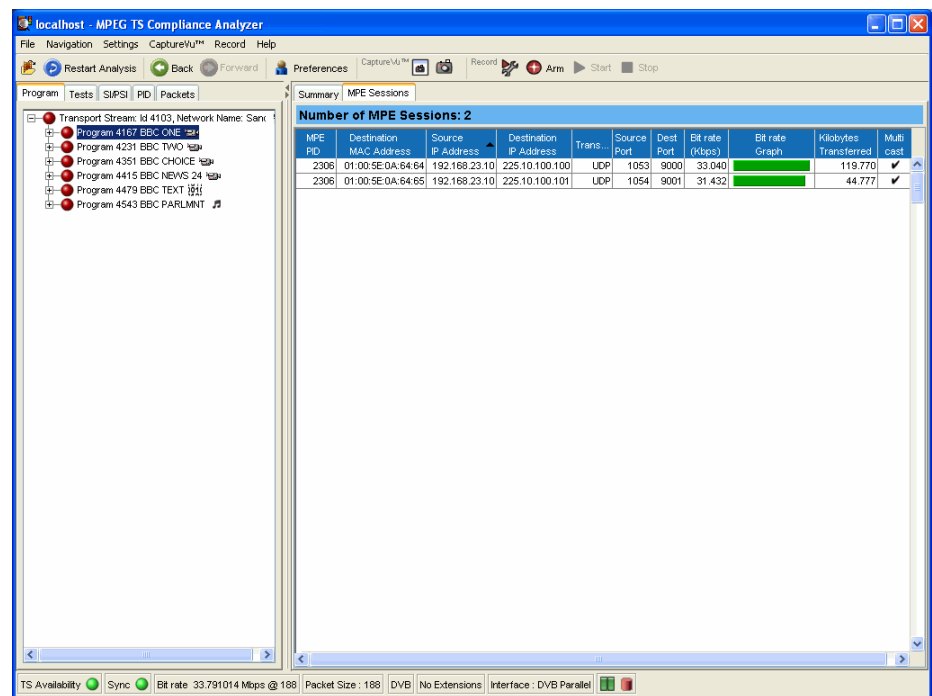

**Figure 2-59: MPE view**

## CaptureVu Feature

The CaptureVu feature allows you to capture and analyze system events during deferred or real-time analysis to debug the intermittent and complex problems that traditional analyzers miss.

The feature can be activated either manually by selecting the Capture button during analysis or automatically by a CaptureVu breakpoint preset on a test. For deferred analysis, a packet number can be identified at which analysis will stop. Any of these actions freezes the analysis and allows details of the analysis up to that moment to be examined.

Links to the packet and the test (where applicable) at the point at which the Capture button was pressed or a designated test failed are displayed in the CaptureVu Settings dialog box.

---

**NOTE.** *If a recurring test failure needs to be examined in its true context, it is advisable to make a triggered recording. With pretriggering set, it is then possible to examine the events surrounding a test failure. See Triggered Recording, page 2–126*

---

## Setting Up the CaptureVu Feature

The feature can be activated when a test flagged with a CaptureVu breakpoint does not fall within the parameters set for the test. Breakpoints can be set at any time. They will be activated during real-time analysis as soon as the flagged test fails. To operate successfully in a deferred analysis stream, the stream may need to be reanalyzed.

You can set a CaptureVu breakpoint as follows:

1. In either the Program or Tests view, locate and highlight the required test.
2. From the shortcut menu, select CaptureVu Breakpoint.

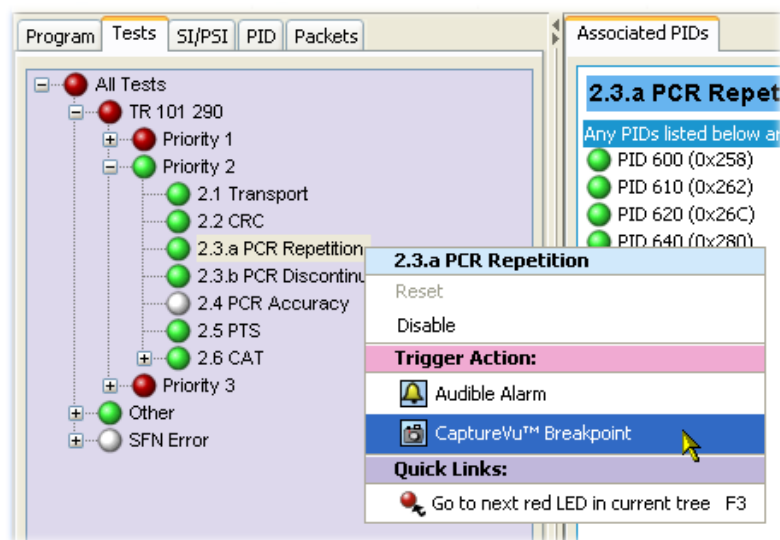

Note the addition of the breakpoint icon beside the test entry.

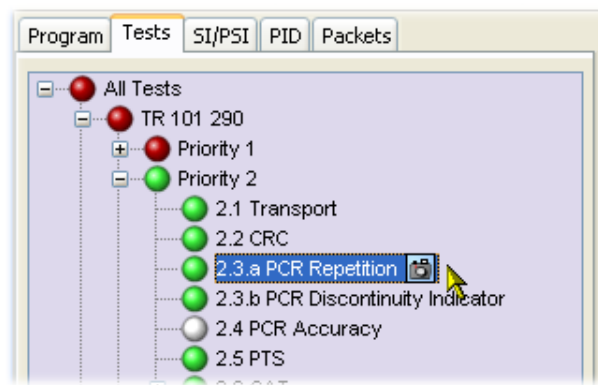

The CaptureVu breakpoint is now set. You can set as many breakpoints as you require. The next time an error is detected on any breakpoint test, analysis (real-time or deferred) will stop and the test will be identified.

### CaptureVu Analysis

The CaptureVu breakpoint will operate during real-time and during deferred analysis. The CaptureVu Settings dialog box is displayed as soon as a breakpoint is reached or the CaptureVu feature is activated from the toolbar.

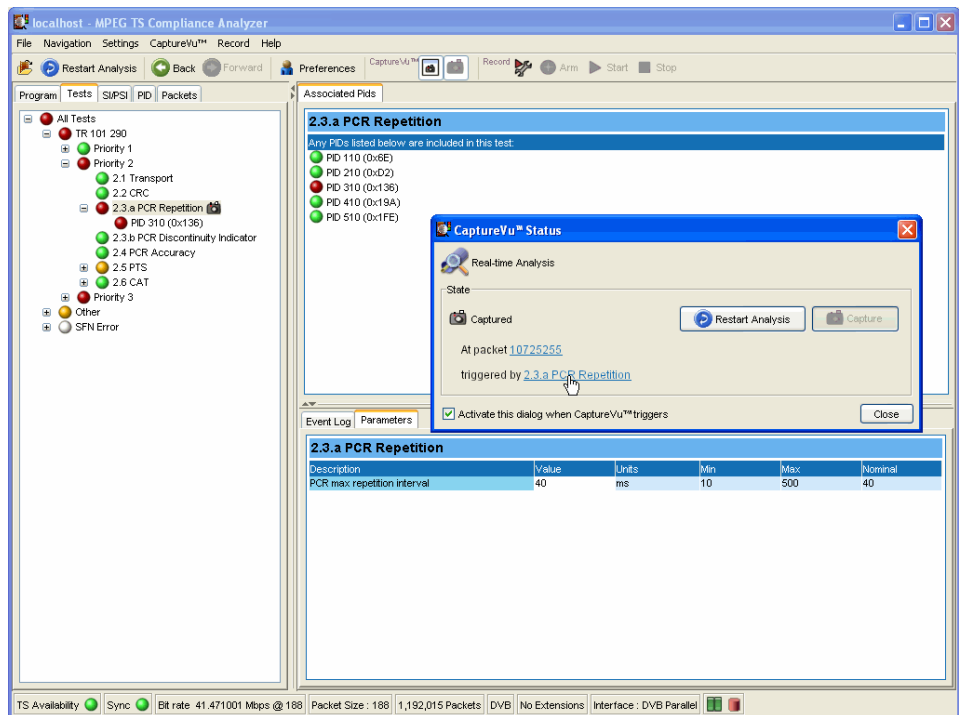

The dialog box contains the following fields:

**State:**

This panel displays the test and packet in which the test has failed. Clicking either the test or the packet identity will open the related view (Tests or Packets) and highlight the test or packet (see Figure 2–60 and Figure 2–61).



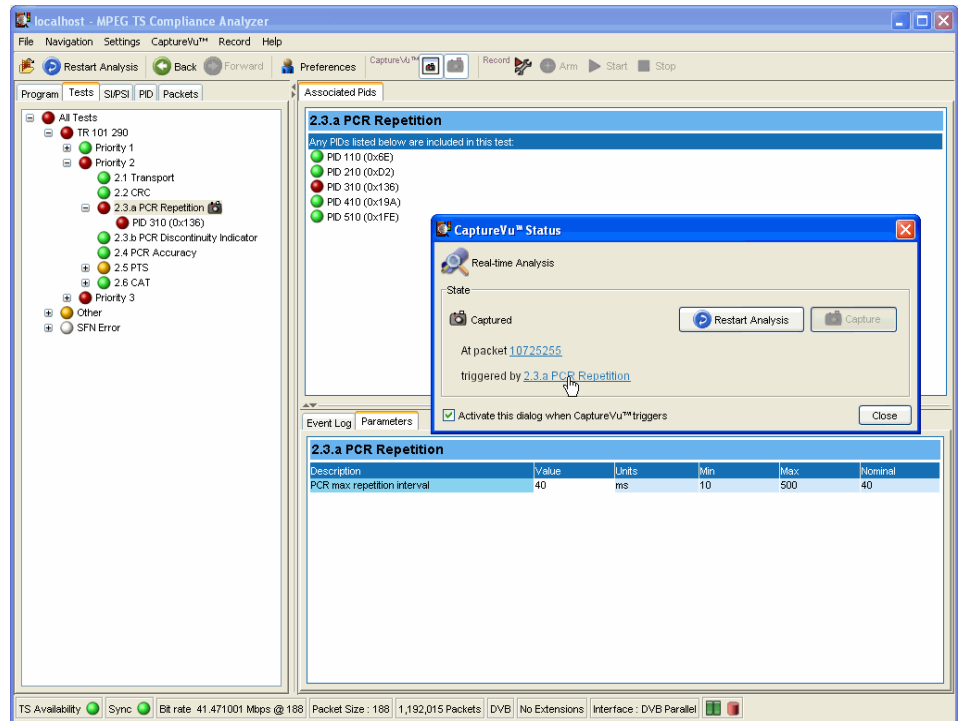
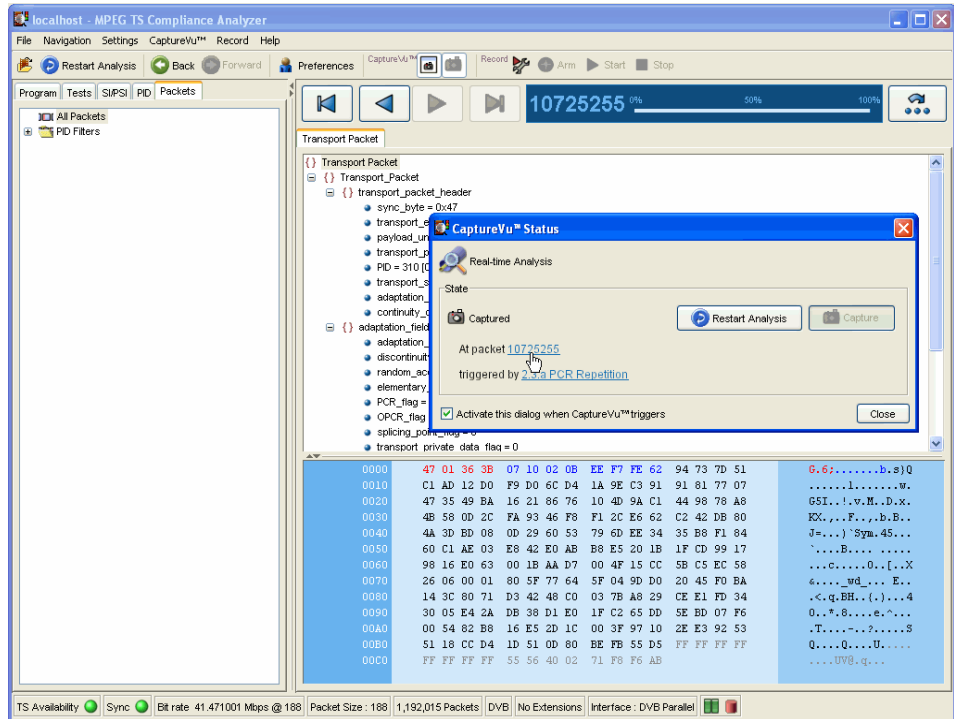

Figure 2-60: CaptureVu breakpoint - Test view



**Figure 2-61: CaptureVu breakpoint - Packet view**

You can activate this dialog when the breakpoint triggers. When enabled, the CaptureVu setting dialog box is opened automatically when a breakpoint occurs.

The CaptureVu Settings dialog box can also be viewed at any time by selecting the CaptureVu Settings button on the toolbar.

With the CaptureVu feature activated, all of the TSCA tools are available for you to analyze and inspect the saved information.

---

**NOTE.** In Packets view, only the packets contained in the last 200 MB are available for analysis.

---

### **Resuming Analysis**

You can resume deferred analysis by selecting the Resume Analysis button from the dialog box or the toolbar.

---

**NOTE.** *When you select the Resume Analysis button, analysis will continue from the point at which analysis was paused.*

---

Similarly, you can resume real-time analysis by selecting the Restart Analysis button from the dialog box or the toolbar.

---

**NOTE.** *While real-time analysis is paused, further analysis is stopped. When the Restart Analysis button is pressed, analysis is restarted at the current time.*

---

## Triggered Recording

During real-time analysis, stream information can only be held for a finite time. Eventually, the stream will be overwritten by more up-to-date information.

To examine events that occur in real-time mode more closely, recordings can be made manually or automatically. Recordings are saved to hard disk and can be subsequently analyzed and examined in more detail.

The Triggered Recording setup is accessed by the Record Setting button on the toolbar or Record > Record Settings... on the menu bar; the Recording Settings dialog box is displayed. The dialog fields are described below:

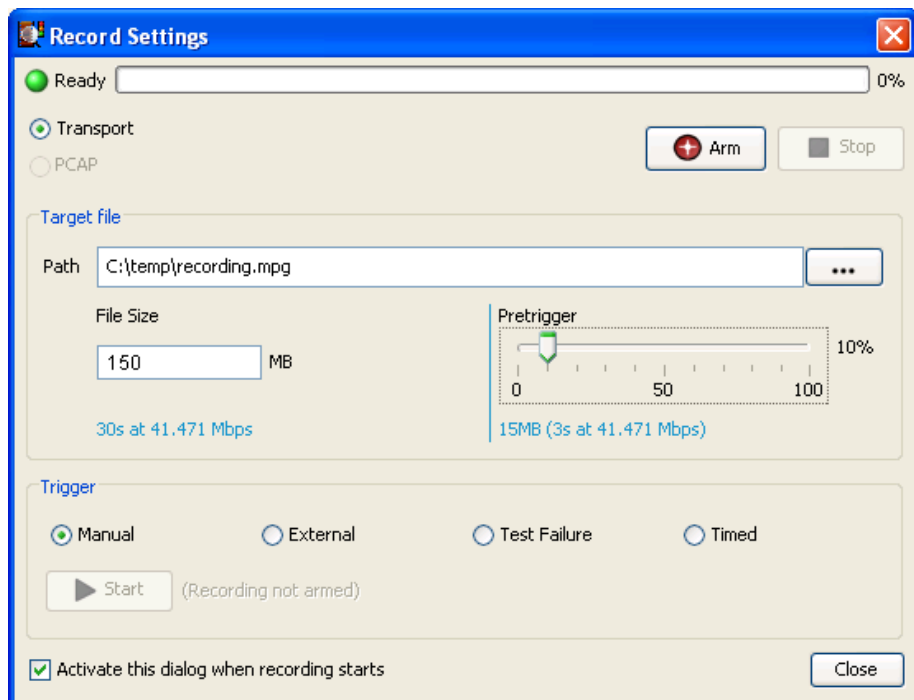
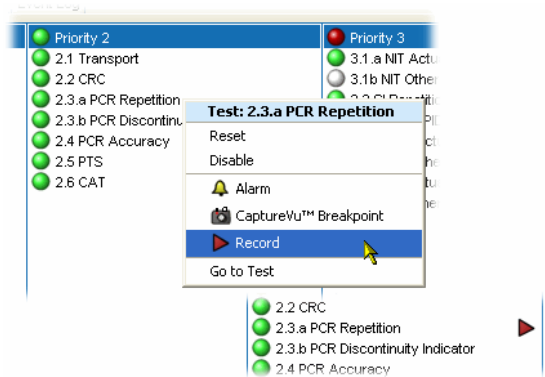

**Figure 2-62: Record Settings dialog box**

- Source selection:** Transport: Default selection.  
PCAP: Only available when Enhanced performance IP card is fitted.
- Status bar:** Indicates the trigger status (Ready, Armed, Recording, or Complete) and the pretrigger/recording progress. The status and progress are also displayed on the toolbar in the main window.

**Target file**

- Path:** Enter the file name and path for the recording or use the browse button to find and select an existing file name. If this file name already exists, you must approve the overwriting of the old file when recording is initiated.
- File Size:** Enter the file size required in megabytes. For example, for a stream at 30 Mbps, a file size of 600 MB would record approximately 160 seconds of stream information.
- Pretrigger:** A proportion of a stream can be recorded before a trigger event occurs. (See *Pretrigger Recording*, page 2–129.) Enter the pretrigger size (as a percentage of file size) that is to be recorded.
- Trigger Type:** The event that triggers the recording can be one of four types, selected from the drop-down list. In each case, the trigger is set and pretrigger recording starts when Arm is selected. Pretrigger recording must be complete before triggered recording will start.
- Manual: Recording will start when the Start button is pressed. IP analysis supports only manual recording.
- External: Recording will start when a rising or falling signal edge is detected at the external trigger input connector. (Refer to the *MTS400 Series Technical Reference*, 071-1724-xx for specifications.)
- Test Failure: Recording will start when an error occurs on a flagged test.
- Tests are flagged by highlighting a test in the Program or Tests view and selecting Record from the shortcut menu. The record icon is displayed next to the test.



You can set the Record flag on as many tests as you require; recording will be triggered by the first flagged test that is encountered.

**Timed:** Recording will start when the time and date set in the Start recording at field is reached.

You can enter the date and time manually (in the format displayed). The date can be selected from the drop-down calendar.

For all trigger types, except manual, when recording is complete, the starting packet is indicated in the Record Settings dialog box. Click on the packet number to display it in the Packets view.

**Arm button:**

Places the recording function into an armed state. If a pretrigger value has been specified, the pretrigger recording will start (as shown by the progress bar). Full recording will start when any trigger requirements are met.

**Stop button:**

Only active during recording, this button either disarms the previously armed trigger or stops recording immediately. Any recording made up to the point when the button is pressed will be lost.

**Start button:**

For manual recording, this button becomes active after arming and any pretrigger conditions have been met; when pressed, recording will start immediately.

The Recording Settings dialog can be left open while waiting for a recording to take place. If, after setting up the recording, the dialog is closed, the recording can be controlled from the toolbar.

## Pretrigger Recording

Setting a pretrigger size allows the condition of the final recording to be examined both before and after a trigger event. Pretriggering a recording allows a section of a recording to be recorded before the trigger event. The pretriggered portion of the file is filled and written over repeatedly until the trigger event occurs.

Pretrigger recording starts when the trigger is armed by pressing Arm.

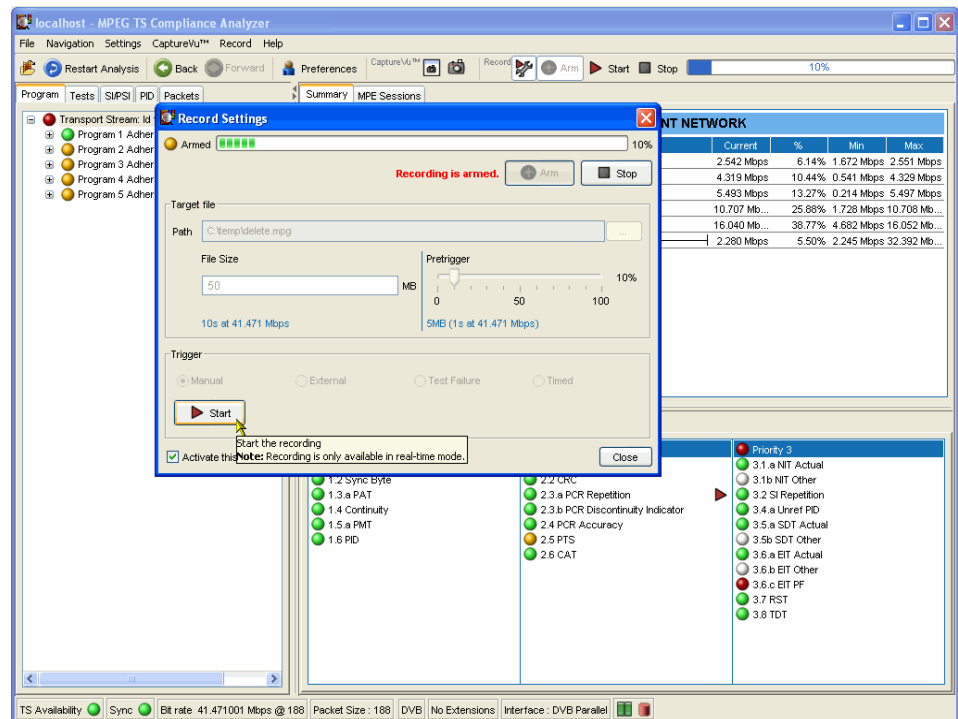

Figure 2-63: Record Settings dialog box - Armed state



**CAUTION.** Recording may fail if the hard disk is unable to match the data rate of the stream. This can be caused by a fragmented hard disk. Regular defragmentation of the hard disk is recommended (refer to your Windows documentation or on-line help).

**NOTE.** No timestamps are stored when performing a recording through an IP interface

## Menu Bar and Options

The Menu Bar provides access to a selection of major system options using drop-down menus.

The menus and their options are described in the following paragraphs.

### File Menu

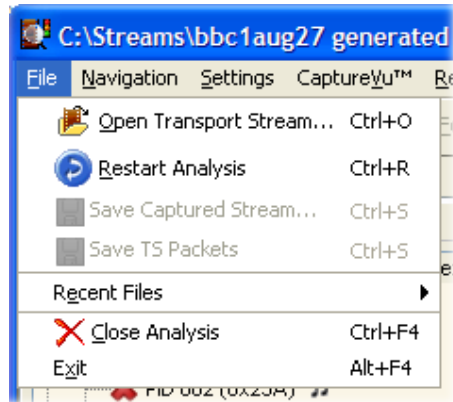
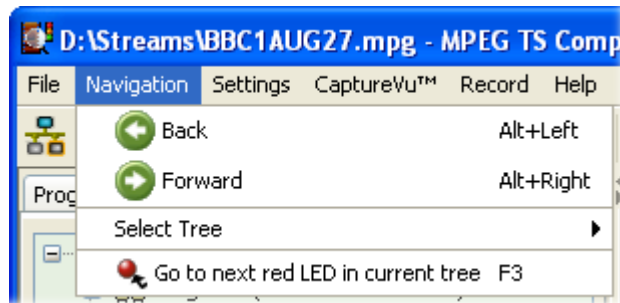

**Table 2-8: File menu options**

Command	Function
Open Transport Stream...	Opens the Open Transport Stream dialog box from which a stream source (file or real-time) and the interpretation standard can be selected.
Restart Analysis	Restarts the current analysis.
Save Captured Stream...	Saves the captured stream (200 MB maximum). Only available in real-time mode.
Save TS Packets	Saves the transport packets from a pcap file with the current IP filtering. Only available in deferred mode.
Recent Files	Lists the most recently analyzed files. Select a file name to reanalyze the file.
Close	Stop and close the current analysis, leaving the TSCA open.
Exit	Exits the TSCA.



## Navigation Menu



**Table 2-9: Navigation menu options**

Command	Function
Back	Returns to previous view.
Forward	Goes to next view.
Select Tree	Allows selection of a navigation view (Programs, Tests, SI/PSI, PIDs, Packets).
Go to next red LED in current tree	Goes to and highlights the next leaf node with an error; parent nodes are passed over since they only indicate lower level errors.

## Settings Menu

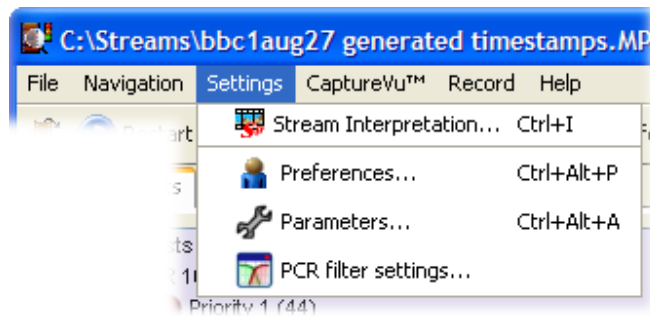

**Table 2-10: Settings menu options**

Command	Function
Stream Interpretation...	Opens the Stream Interpretation dialog box (see page 2-7); the current settings can be changed; analysis will be restarted when the new settings are accepted.
Preferences...	Opens the Preferences dialog box which enables interface management (see <i>Preferences</i> , page 2-133).

**Table 2-10: Settings menu options (Cont.)**

Command	Function
Parameters...	Opens the Parameters dialog box which allows all stream parameters to be viewed and edited.
PCR filter settings...	Opens the PCR Drift/Jitter Demarcation Filters dialog box which allows PCR drift and PCR jitter to be differentiated.

### CaptureVu Menu

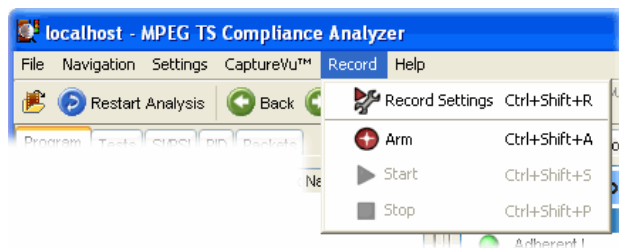

**Table 2-11: CaptureVu menu options**

Command	Function
CaptureVu Status...	Opens the CaptureVu status dialog box.
Capture	Pauses the current analysis to allow detailed inspection.
Resume	Resumes analysis (only available in deferred analysis mode.)

### Record Menu

The Record menu is only available during real-time analysis.



**Table 2-12: Record menu options**

Command	Function
Record Settings	Opens the Record Settings dialog box.
Arm	Arms the record function.
Start	Starts recording.
Stop	Stops recording.

## Help Menu

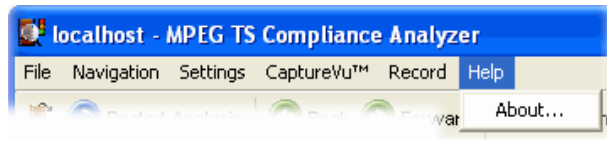

**Table 2-13: Help menu options**

Command	Function
About...	Displays application and system information.

## Preferences

Three options are offered when the Preferences dialog box is opened (Settings > Preferences...): General, Font, and Decode.

### General

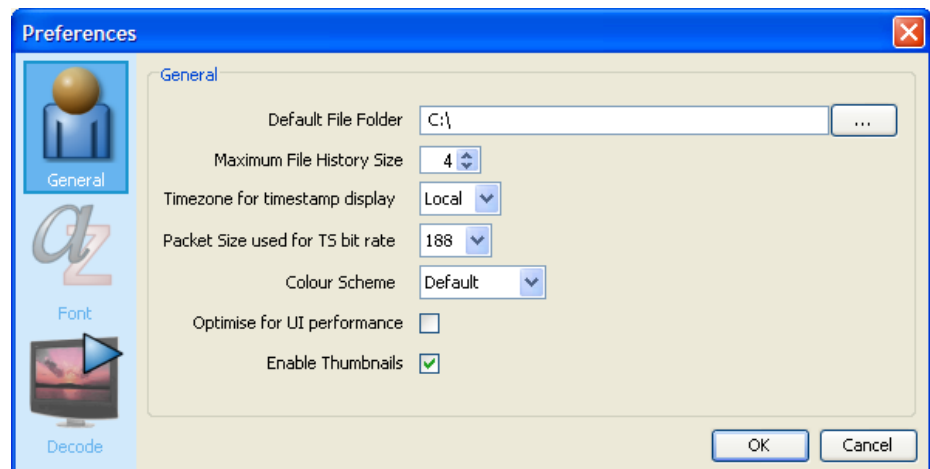

**Figure 2-64: Preferences - General**

The General preferences option allows you to specify a default folder for loading and saving files. Either enter the path required or use the browse button to locate the folder. Select OK to save the setting and close the dialog box.

**Default File Folder:** Specify the default folder for loading and saving files.

**Maximum File History Size:**

Specify the maximum number of file names to be shown in the File > Recent Files list.

**Timezone for timestamp display:**

This selection is not currently used. Ensure that it is set to **Local**.

**Packet Size used for TS bit rate:**

Specify the packet size (188 or 204) to be used to calculate the transport stream bit rate. This is displayed in the status bar.

**Color Scheme:**

Select the background color for all graphs. When Default is selected, the graphs are based on a white background. When Instrument is selected, the graphs are based on a black backgrounds.

**Optimize for UI performance:**

Under some circumstances when analyzing large files or using low specification instruments, the user interface may appear to freeze until the deferred analysis is complete. Enabling this feature will cause the user interface to refresh at more regular intervals, thus reassuring you that the analysis is progressing.

**Enable thumbnails:**

Thumbnail views of program content will be displayed when this option is enabled.

**Font**

The Font preferences option allows you to specify the display font and size for log entries and stream content. Place the cursor in the field to be changed and select the font name or font size required from the displayed drop-down list.

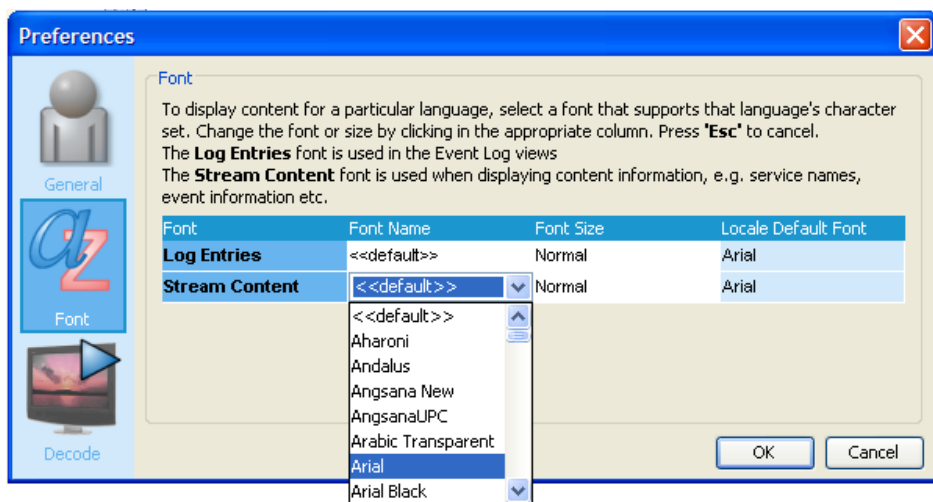

**Figure 2-65: Preferences - Font**

**Decode** The decode preferences relate to the VLC Media Player that can be used to play elementary stream video and audio content.

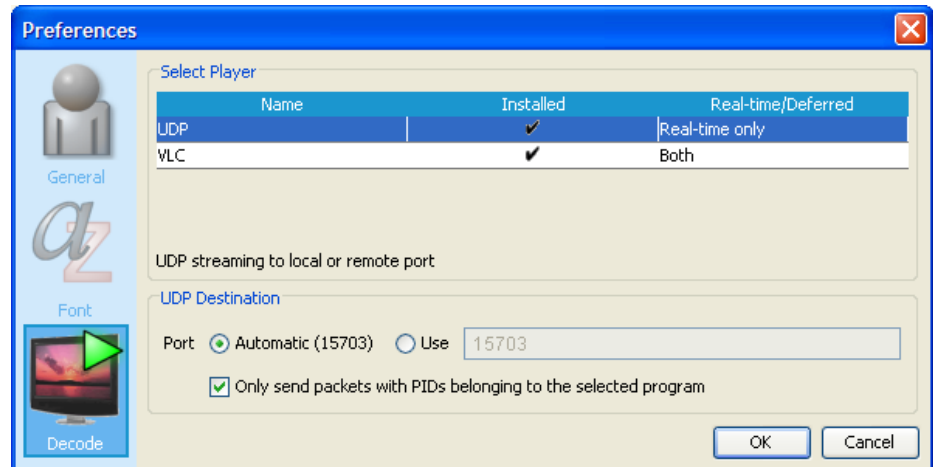

**Figure 2–66: Preferences - Decode**

**VLC.** Selecting the VLC setting indicates that a stream should be sent to the VLC Media Player.

**UDP.** The UDP setting, which is only available for real time systems, is used to designate the port over which streams should be sent to external players, for example, the MPlayer. The UDP Destination can be set either automatically or manually.

## Script Files

In the TSCA, scripts provide a method of interpreting and displaying standards during analysis. Scripts provide templates, which determine how the SI information found during stream analysis will be displayed. The scripts must cater for all the information that may be found in a stream, including the various table types found in all of the identified standards. To this end, it has been found that the best approach is to make the scripts modular; each script module deals with different aspects of the SI and standards.

For example, when DVB is identified as the standard against which to analyze, the scripting dialog box displays a list of Script modules. Additionally, when it is known that tables or descriptors not commonly carried in the identified base standard and region are likely to be included, extra scripts can be written and added to the Script Files list to be used for the analysis.

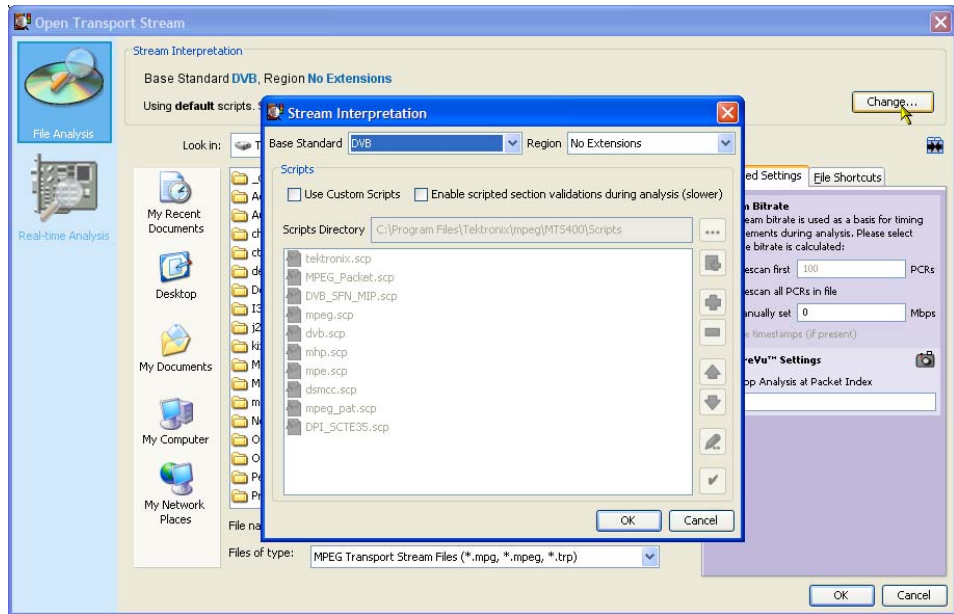

**Figure 2-67: Stream Interpretation dialog box**

Essential scripts are installed and enabled using the Stream Interpretation dialog box. In the absence of any enabled scripts, only the PAT table will be analyzed, and all other data will be presented as private data.

Scripts can be customized or new scripts can be written to analyze private data. With the Custom Scripts checkbox enabled, if a suitably configured script is selected and enabled before a stream is analyzed, custom data will also be analyzed when the stream is opened.

Scripts can be selected and enabled when files are open; analysis will restart as soon as any changes are accepted.

A script file will not be used for analysis until it is present in the Script Files panel of the Open Transport Stream dialog box.

## Setting Stream Interpretation

Set the stream interpretation as follows:

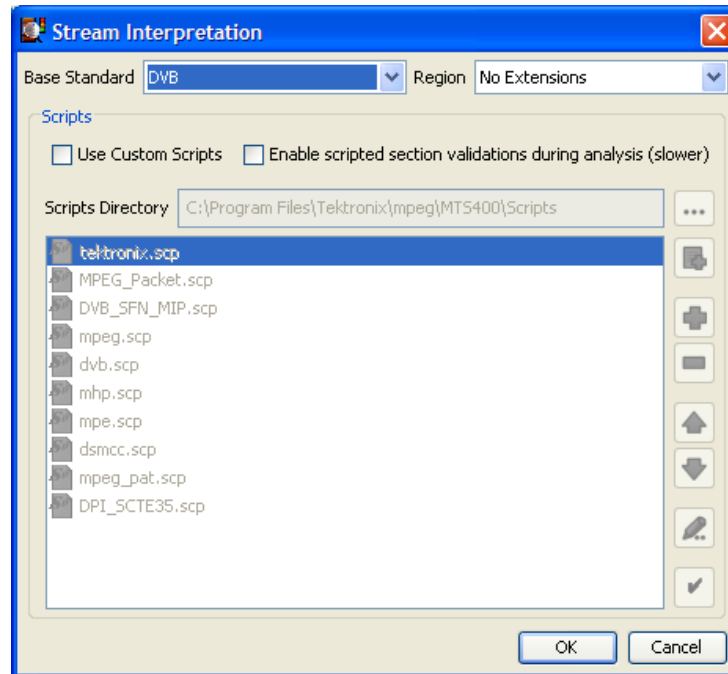

1. From the Base Standard drop-down list, select the required base standard.

The selected standard will dictate the availability of options that are available in the Regions drop-down list.

2. From the Region drop-down list, select the required region.

The regions list allows country-specific extensions to be added to the base standard scripts. If No Extensions is selected, only the standard scripts are listed in the script list. The remaining country-specific extensions add extra scripts to the current listing. Scripts that will be used are listed in the main pane.

Scripts listed by default are resident in the default installation directory (program files\tektronix\mpeg\mts400\scripts). Other directory locations can be specified in the custom script selection mode. All selections will be retained between TSCA sessions.

3. Select OK to confirm changes.

Scripts are syntactically analyzed when the OK button is selected. A fault in the syntax of a script will not necessarily prevent a stream from being analyzed, but it may result in an incomplete analysis of the stream. Errors in the script syntax will be noted in the stream log.

### Custom Script Selection

When the Custom Scripts checkbox is enabled, the buttons beside the script listing become active and custom scripts can be selected in addition to the standard scripts. Some script names in the listing are dimmed; these are considered to be essential and cannot be removed.

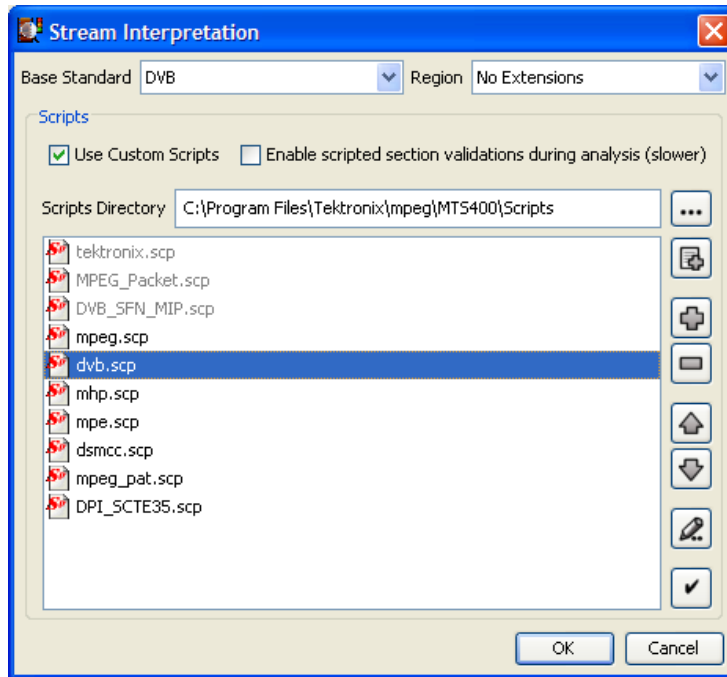



The buttons operate as follows:

- 

Resets the script list to the default list for the standard and region.
- 

Opens the script selection dialog box. You can highlight the required script and select OK. Note that the script name is added to the Script Files list.
- 

Removes any script name highlighted in the Script Files list.
- 

Scripts are applied to streams in the order that they are listed in the Script Files list. Use these buttons to move a highlighted script up and down in the list.
- 

Opens the highlighted script in ScriptPad (the Tektronix script editor).
- 

Verifies the syntax of the scripts listed in the Script Files pane. A message window lists any errors found.



If the standard script list has been changed and you want to return to the default list of scripts, highlight the Base Standard and Region required, and select the default script button. The list will be overwritten with the default list.

(More information about ScriptPad can be found in the *MTS400 MPEG Test System User Manual*.)

### **Scripts Directory**

The Scripts Directory field indicates the root directory for scripts named in the Script Files list when analysis starts. If scripts are not present in the scripts directory, the interpretation and validation of the SI will be incomplete.

---

**NOTE.** *If the script list is modified in any way, always use the ✓ button to verify the changes.*

---

Scripts can be selected from any directory (using the + button). If the directory is not the same as that identified in the Scripts Directory field, the path (either relative or absolute) will be displayed with the script name in the Script Files list.

---

**NOTE.** *The Scripts Directory browse button allows you to specify a default directory for script selection. The browse window does not display the scripts available. If you need to see the scripts available, use the Windows Explorer.*

---

If the standard script list has been customized and you want to return to the default list of scripts, highlight the required Base Standard and Region and select the default script button. The list will be overwritten with the default list.

---

**NOTE.** *Each Base Standard and Region combination can be individually customized.*

---

### **Script Validation**

Validating scripts checks the syntax of the listed scripts.

If the “Enable scripted section validations during analysis” check box is enabled, the scripts are checked during analysis to ensure that the data as defined by the scripts is as expected (for example, values are within specified ranges). A fault in the syntax of a script will not necessarily prevent a stream from being analyzed, but it may result in incomplete analysis of the stream. Errors in script validation will be logged in the stream error log. Enabling this check box may have an impact on real-time analysis.



# Task Examples

The examples in this section describe how to locate a fault or information using the analyzer.









The examples assume a basic understanding of the analyzer user interface and that you are familiar with the more important aspects of digital television transport stream structure and interpretation standards.

The MPEG Test System is a tool which allows you to analyze a transport stream and then examine it in detail. Errors in the content can be identified and examined to byte level.

Because of the comprehensive nature of the analyzer, there are a number of ways of achieving your objective. In these examples, one or more ways are described to achieve the objective.

## Error Status

LED icons are used throughout the analyzer interface to represent the status of the tests applied to associated items, for example, programs. Colors used are as follows:

-  (Red) Error; test failed
-  (Yellow) Transient error (error not currently being detected but has been seen since last reset)
-  (Green) No error; test passed
-  (Dark Blue) Warning (Interface tab only)
-  (Light Blue) Transient warning (warning not current, but has been detected since last reset) (Interface tab only)
-  (Gray): Test disabled
-  (White) Test not applicable or unknown state
-  (Red) PID referenced but not found in the stream
-  (Green) PID referenced but not found in the stream; applicable test disabled.

When an LED represents a parent node in a tree (for example, a program node is the parent of elementary stream nodes) or a navigation tab, the color represents the worst case of all of its tests and the worst case of all of the tests represented by its child nodes.

Similarly, when an LED representing a parent node in a tree is disabled or enabled, all subsidiary (or child) nodes are also disabled or enabled to reflect the state of the parent node. When an LED representing a parent node is reset, all the child nodes are also reset.

## Which tests have failed in an analyzed stream?

In this example, the analyzer has just finished analyzing a stream. The Program navigation view is initially displayed with the transport stream tree collapsed. The transport stream error LED is red, indicating that one or more tests have failed (see also page 2–27).

**Method** With the Program tab still selected, view the tests summary view (bottom right).

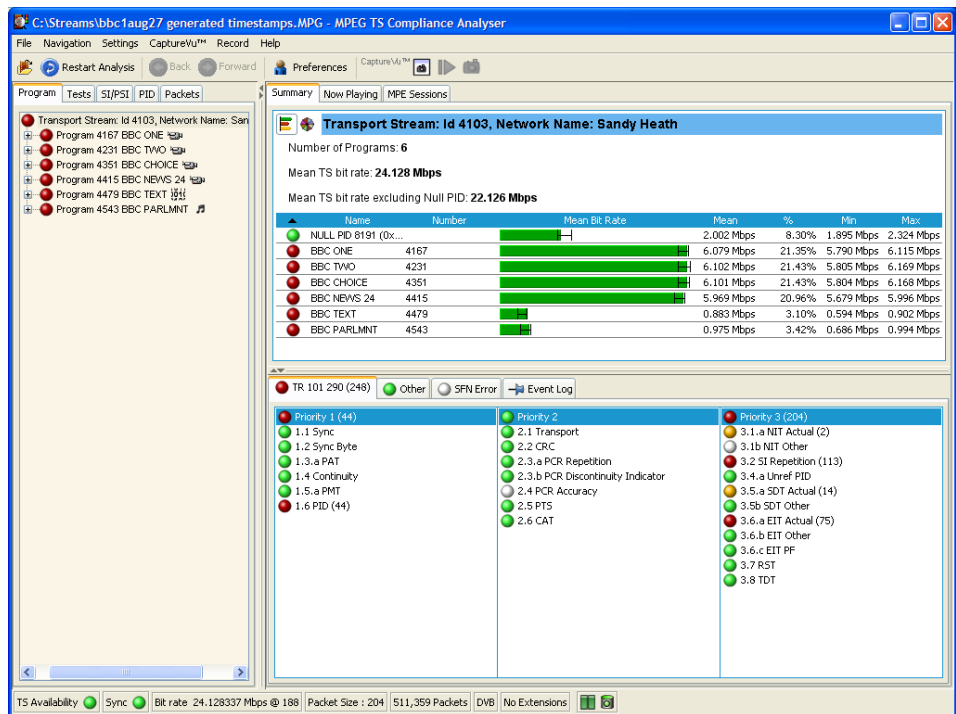

Figure 2–68: Failed tests - example

Identify the tests that have failed (red LED). As shown in Figure 2–68, in test summary view (TR 101 290 tab), the following tests have failed:

- First Priority: 1.6 PID

- Third Priority: 3.1a NIT Actual; 3.2 SI Repetition; 3.5a SDT Actual; 3.6a EIT Actual

Remember that the tests may be distributed over more than one tab in the test summary view; the color of the LED on the tab helps you locate the failed tests (for example, the Other tab in Figure 2–68).

You can view a test (and see other PIDs that it has failed on) by highlighting a test and selecting “View this Test in Tests Tree” from the shortcut menu:

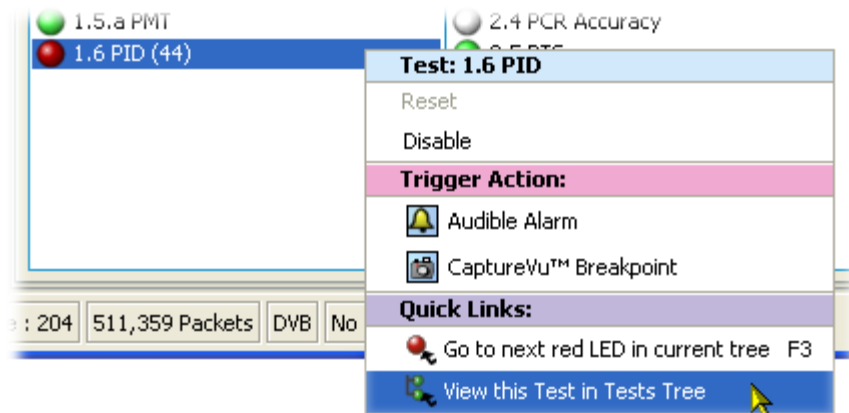

You can also display the fault by expanding the tree in the Tests navigation view until the fault is revealed.

Expanding the test itself reveals the PIDs that have failed the test.

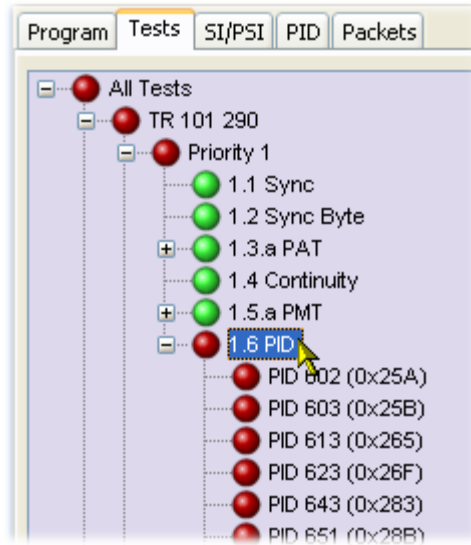

## How many PIDs are there in a stream?

## How many PIDs are referenced?

## How many are unreferenced?

For this task, the PID navigation view is used to view information about individual PIDs in the transport stream. Under the All PIDs node, which displays all of the PIDs in the summary view, there are four subgroup nodes: Reserved PIDs, Referenced PIDs, Unreferenced PIDs, and User PIDs. The number (in parenthesis) in each node gives the number of PIDs found during analysis.

- Method**
1. Select the PID navigation view.

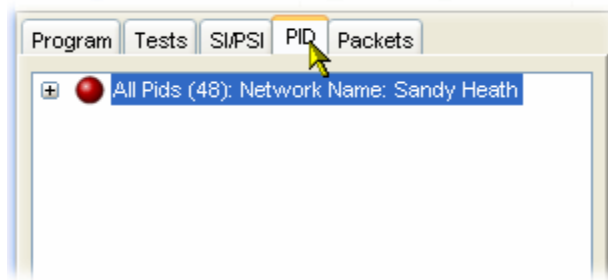

2. Expand the All PIDs node to display the subgroups (and their quantities).

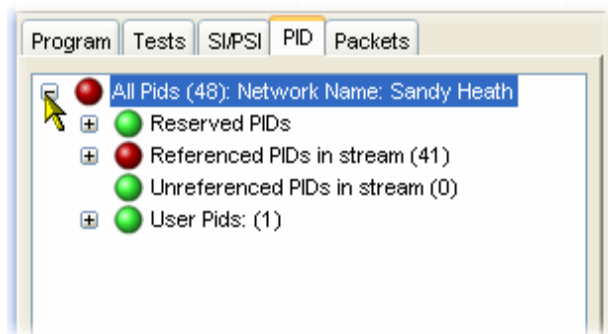

## What tests have been applied to a program PID?

1. Select the Program navigation view.

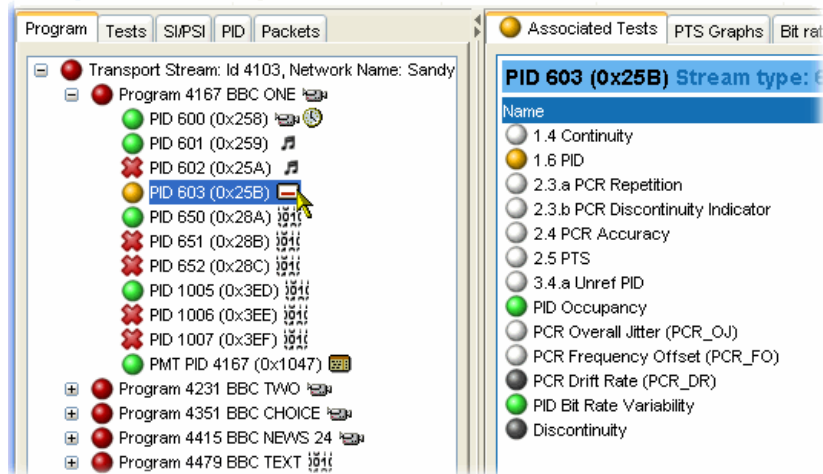

2. Expand the Transport Stream tree until the required PID can be highlighted.

In the Associated Tests view, note the tests that are enabled. Gray LEDs indicate tests that have been disabled, and white LEDs indicate tests that are not applicable to the selected PID.



## Establish the stream type of a PID

- Method 1** 1. Select the Program navigation view.

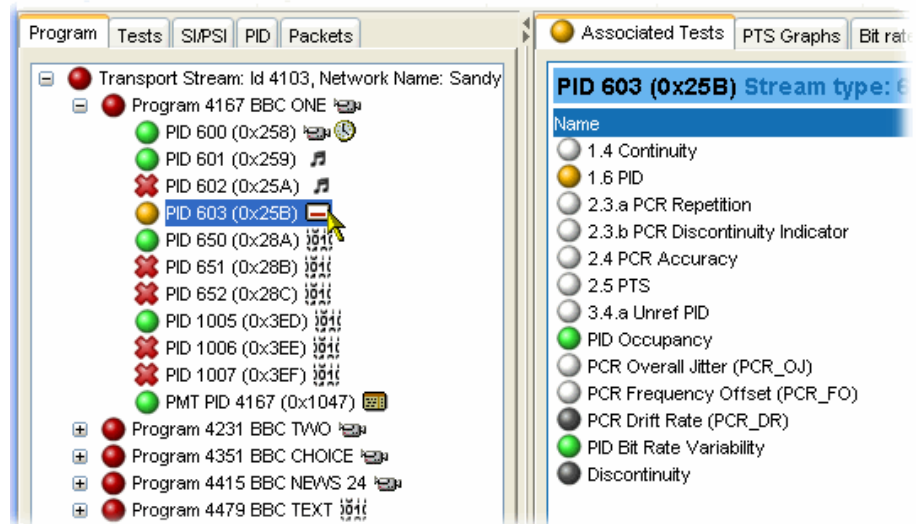

2. Expand the Transport Stream tree until the required PID can be highlighted.
3. Keep the cursor over the PID. A tooltip will display the stream type.

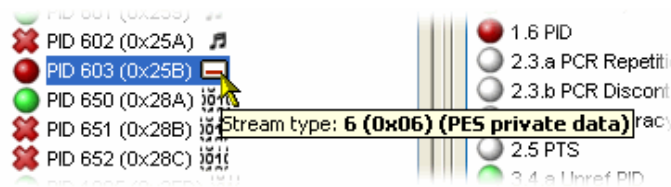

The tooltip is available wherever the selected PID node is displayed (for example, in the PID navigation view).

- Method 2**
1. Select the Program navigation view.
  2. Select the program node.
  3. In the summary view, select the Summary tab.

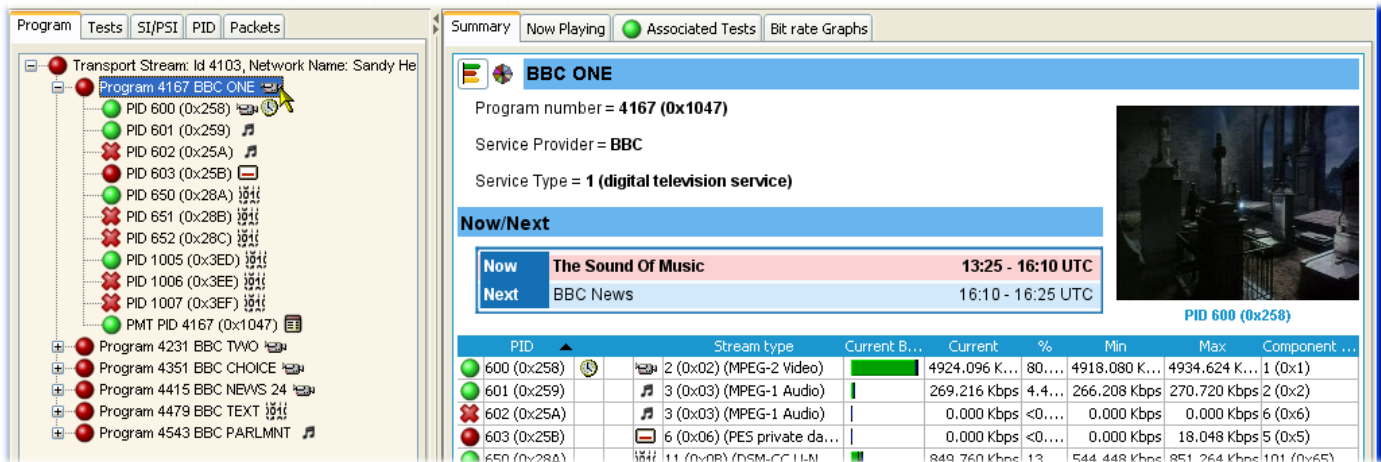

Note the Stream Type column in the display. The stream type is given for each PID in the selected program.

## How many programs are there in the stream?

1. Select the Program navigation view.
2. Expand the Transport Stream tree and note the number of program nodes (see Figure 2–69).
3. The Summary view (bar chart or pie chart) also displays a program count.

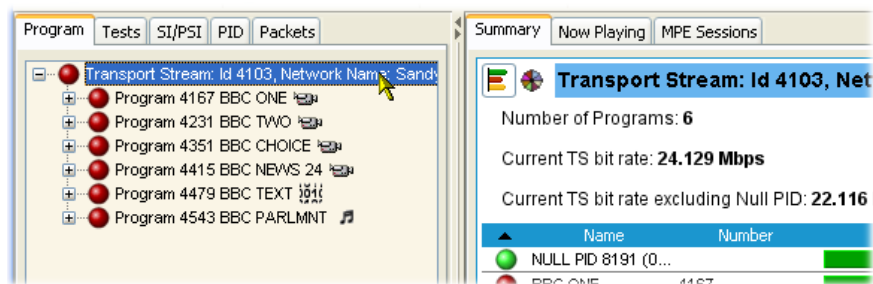

Figure 2–69: Program count

## What are the contents of the programs? And what PIDs are they on?

1. Select the Program navigation view.
2. Expand the Transport Stream tree and a program node (see Figure 2–70).
3. Note the number of program PIDs. Note also that each PID is accompanied by an icon indicating the stream type. Hover the cursor over a PID node to display more information.
4. The Summary and the PID Information views also display the program PIDs.

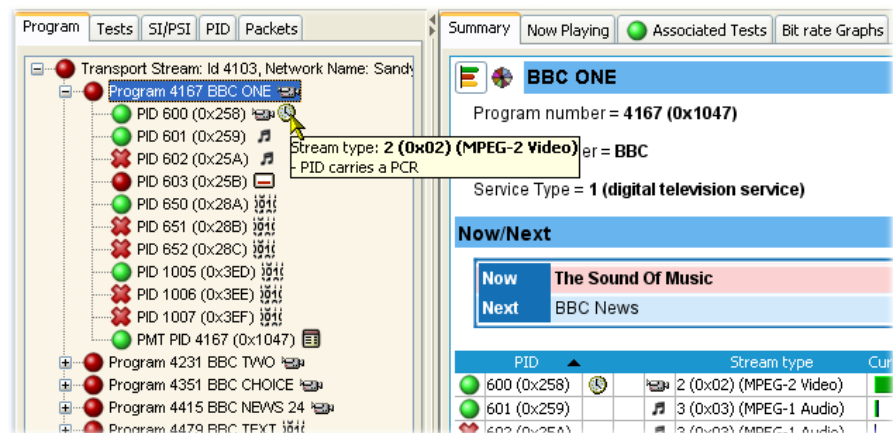

Figure 2–70: PID count

## What is the bit rate of each PID in a program?

Bit rates are displayed in the Program and PID summary views. The bit rates displayed depend on the node highlighted in the navigation view.

**Table 2-14: Bit rate views**

Navigation View	Node	Bit rates displayed in Summary view
Program	Transport Stream	All programs
Program	Program	Program PIDs
PID	All PIDs	All PIDs
PID	Secondary nodes (Reserved, Referenced, Unreferenced, and User)	PIDs in secondary groups PIDs

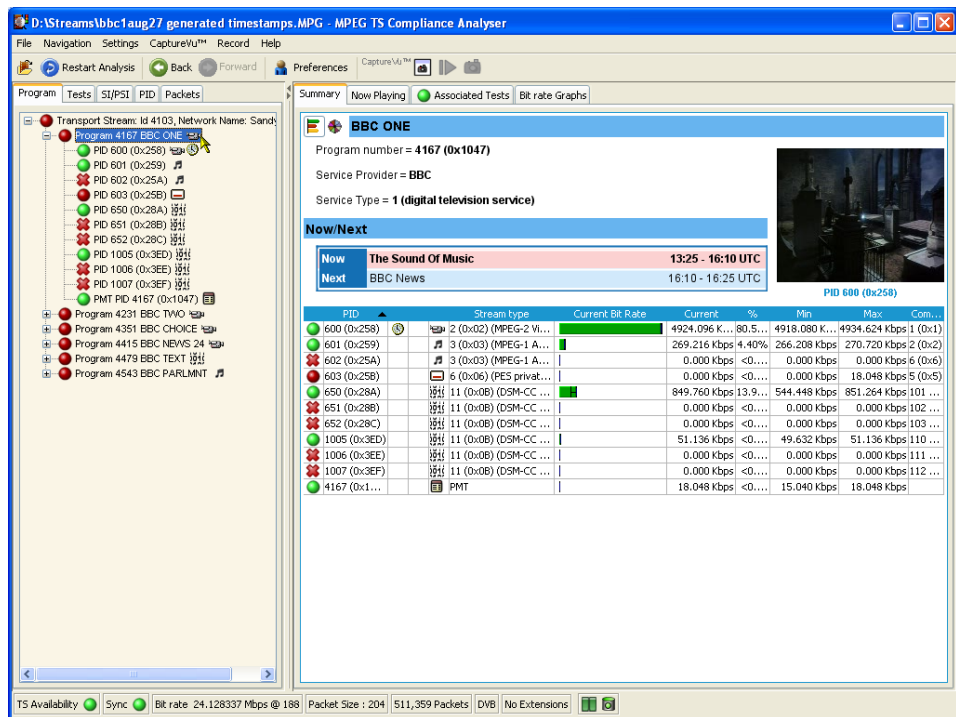

**Figure 2-71: Program PID bit rate - bar chart**

The PID bit rate summaries can be displayed as either bar charts or pie charts by selecting the appropriate icon at the top left of the Summary view.

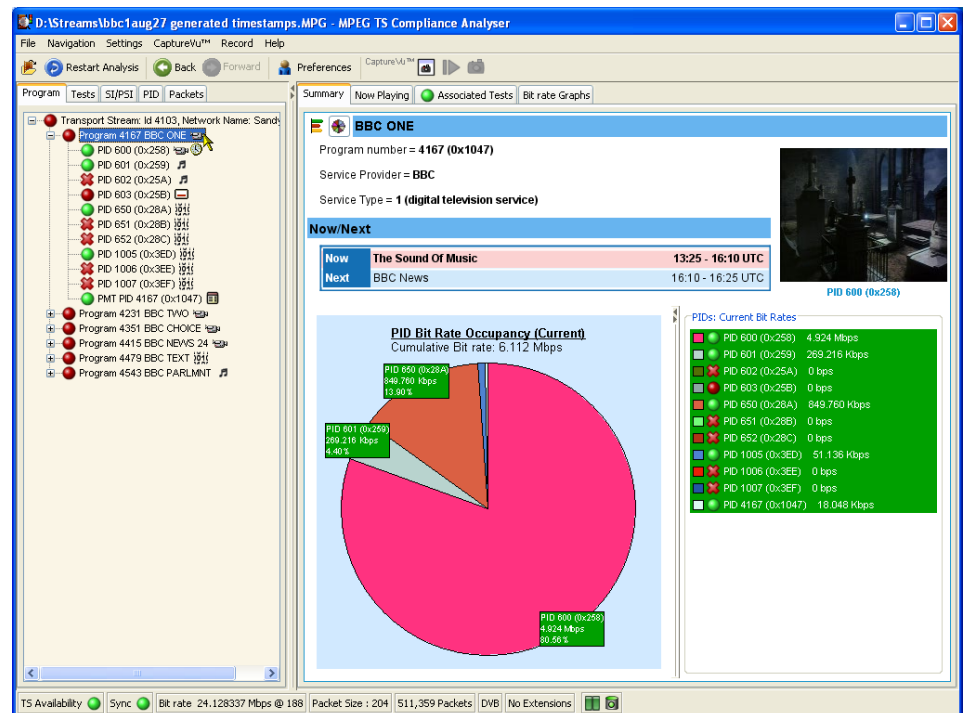

**Figure 2-72: Program PID bit rate - pie chart**

A selection of statistics for each program or PID is shown in the charts. Either current or mean bit rates can be shown by selecting the Show Mean Values option from the Summary view shortcut menu. For deferred analysis, the current bit rate is the final bit rate.

You can also display a bit rate graph for the highlighted node by selecting the Bit Rate Graphs tab.

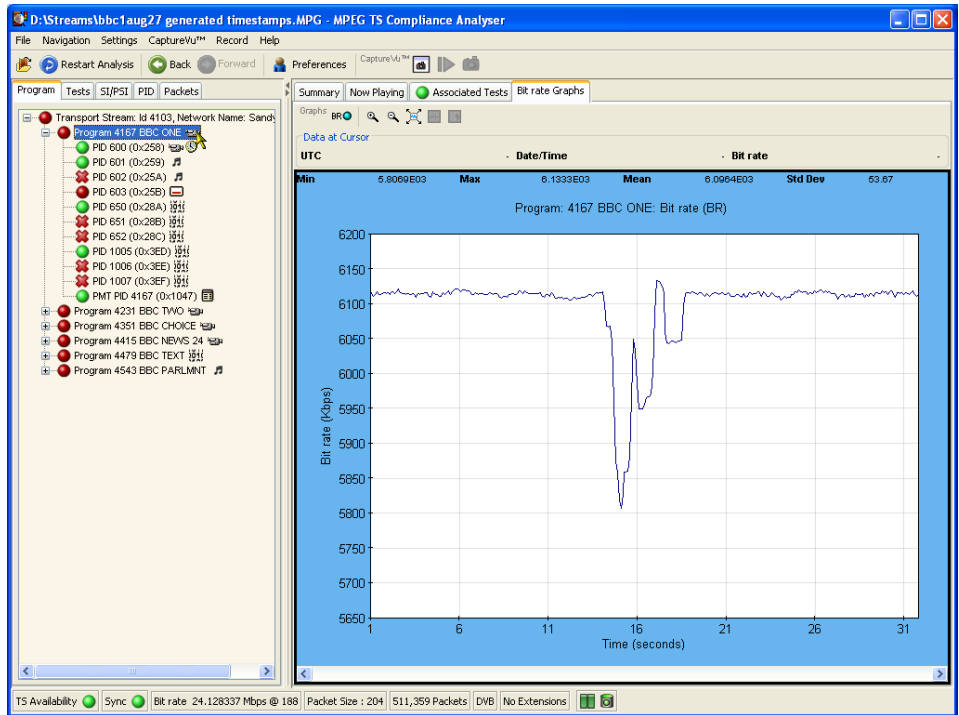

Figure 2-73: Bit rate graph

## What is the latest version number of the Program Association Table (PAT) in the SI?

Tables and their versions can be found in the Tables (SI/PSI) view. When a node representing a table is selected in the navigation view, the table identity and the version are displayed in summary view (top right) as shown in Figure 2–74.

The screenshot shows the MPEG TS Compliance Analyzer interface. The navigation tree on the left is expanded to show 'Tables' > 'Programs (PAT/PMT/SDT actual)' > 'PAT'. The main summary area displays the following information:

Table ID 0, Version 0 @ 00:00:00 (carried on PID 0)

**PAT**

**Attributes**

Transport Stream ID = 1 (0x1)

**5 Programs**

Program Number	PMT PID
1 (0x1)	PID 100 (0x64)
2 (0x2)	PID 200 (0xC8)
3 (0x3)	PID 300 (0x12C)
4 (0x4)	PID 400 (0x190)
5 (0x5)	PID 500 (0x1F4)

The status bar at the bottom shows: TS Availability (green), Sync (green), Bit rate 41.470997 Mbps @ 188, Packet Size: 188, 1,650,000 Packets, DVB, DTG, and signal quality indicators.

**Figure 2–74: Table Identity and Version (summary view)**

The table identity and version can also be seen in the table header using the Tables (SI/PSI) section view as shown in Figure 2–75.

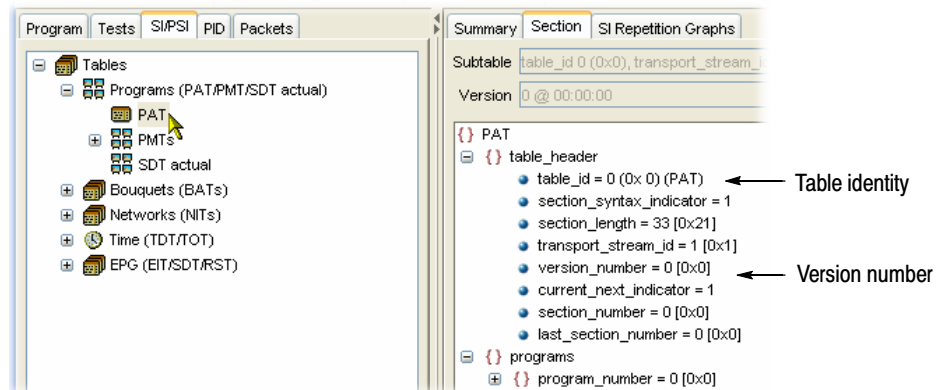

Figure 2-75: Table Identity and Version (section view)

## Examine a Transport Packet

A transport stream packet is a unit of data that contains a header and a payload. The Packets view allows individual transport stream packets to be identified and examined.

### Navigating around the packets



The navigation bar at the top of the Packet summary view is used to move between packets. How the controls work depends on the selection in the Packets navigation view. If All Packets is highlighted, the controls will operate on all packets. If a PID has been identified, added to the PIDs node and highlighted, the controls will operate only on packets carrying the selected PID.



Current packet position



The packet position bar shows the position of the selected packet in the stream.

The controls work as follows:

	Selects the first available packet (in the stream or carrying the selected PID).
	Selects the previous available packet (in the stream or carrying the selected PID).
	Selects the next available packet (in the stream or carrying the selected PID).



---

	Selects the last available packet (in the stream or carrying the selected PID).
	Opens the Go to packet... dialog box.

---

The packet position bar can also be used to navigate through the stream. You can use the cursor to point to and click the next packet to be displayed. Similarly, double-click the packet number in the bar and enter the required packet number in the Go to packet... dialog box.

### Looking at the packet

Having identified and selected a packet, the Packets summary view displays the interpreted code and the raw data in hexadecimal and ASCII format.



# SI/PSI Nodes

The Tables view (SI/PSI tab) displays the service information in tree form. The tree represents all of the service information tables found in the analyzed stream that comply with the selected digital video standard (including MPEG program specific information, DVB service information, and ATSC and ISDB program and system information protocol). The tree contains nodes for each table found; tables and nodes are grouped together functionally.

This section identifies the nodes that may be present for each standard.

Figure 2–76 shows an example of Table navigation view with DVB stream interpretation selected.

Tables 2–15 to 2–19 show the nodes that may be displayed in the SI/PSI navigation view depending on the selected interpretation standard and the content of the stream.

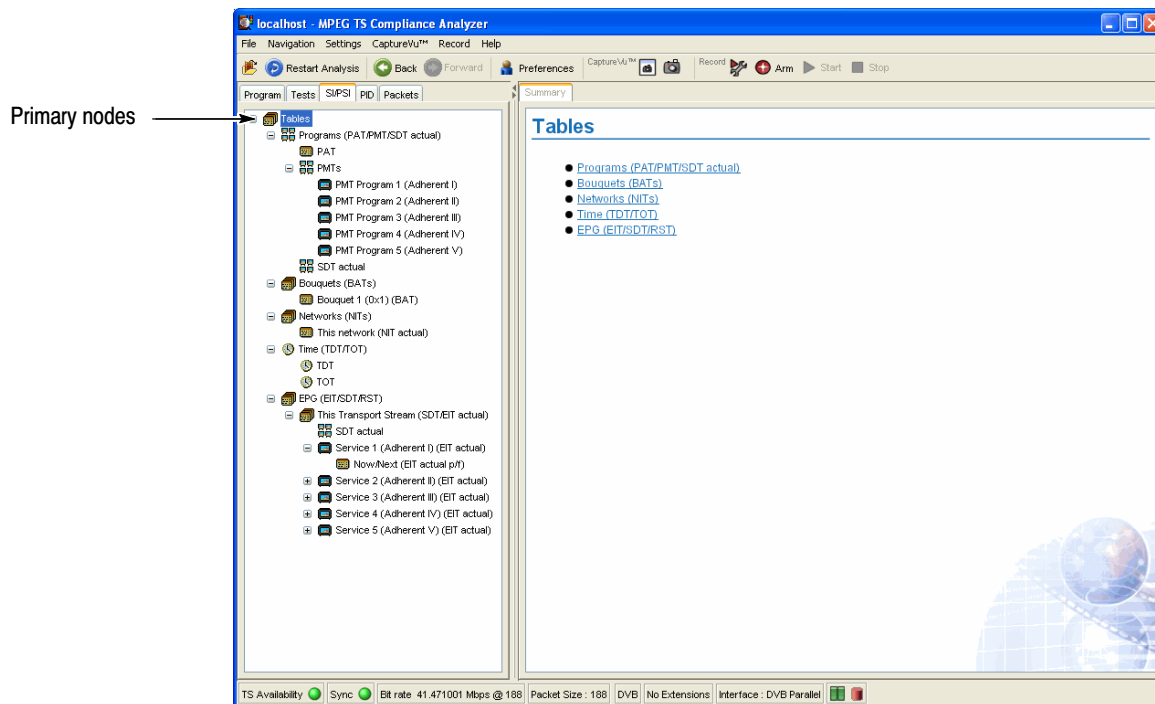

Figure 2–76: Primary SI/PSI nodes (DVB example)

**Table 2-15: MPEG SI/PSI**

Primary node	Subsidiary node
<b>TS info</b>	
	TSDT
<b>Programs</b>	
	PAT
	PMT PIDs
<b>Conditional access</b>	
	CAT
<b>Other Tables</b>	

**Table 2-16: DVB SI/PSI**

Primary node	Subsidiary node 1	Subsidiary node 2	Subsidiary node 3
<b>TS info</b>			
	Partial TS		
		DIT	
		SIT	
	BIT		
<b>Programs</b>			
	PAT		
	PMT PIDs		
		PMT PID +	
	SDT		
<b>Bouquets</b>			
	BAT		
<b>Conditional access</b>			
	CAT		
<b>Networks</b>			
	NIT - This		
	NIT - Other		
<b>Time</b>			
	TOT		

Table 2-16: DVB SI/PSI (Cont.)

Primary node	Subsidiary node 1	Subsidiary node 2	Subsidiary node 3
	TDT		
<b>EPG</b>			
	This TS		
		SDT Actual	
		Service (number, name)	
			Now/Next (EIT P/F)
			Schedule (EIT schedule)
	Other TS		
		SDT Other	
		Service (number, name)	
			Now/Next (EIT P/F)
	RST		
<b>MHP apps</b>			
<b>Other tables</b>			

Table 2-17: ATSC SI/PSI

Primary node	Subsidiary node 1	Subsidiary node 2	Subsidiary node 3	Subsidiary node 4
<b>TS info</b>				
	MGT			
<b>Programs</b>				
	PAT			
	PMT PIDs			
	VCT C/T			
	ETT-V			
<b>Conditional access</b>				
	CAT			
<b>Ratings</b>				
	RRT+			
<b>Time</b>				

**Table 2-17: ATSC SI/PSI (Cont.)**

Primary node	Subsidiary node 1	Subsidiary node 2	Subsidiary node 3	Subsidiary node 4
	STT			
<b>EPG</b>				
	Source/Services			
		EIT0 > EIT127		
<b>Directed channel change</b>				
	DCCT id +			
	DCCSCT			
<b>Other tables</b>				

**Table 2-18: ISDB-S SI/PSI nodes**

Primary node	Subsidiary node 1	Subsidiary node 2	Subsidiary node 3	Subsidiary node 4
<b>TS info</b>				
	Partial TS			
		DIT		
		SIT		
	BIT			
<b>Programs</b>				
	PAT			
	PMT PIDs			
	SDT			
<b>Conditional access</b>				
	CAT			
<b>Networks</b>				
	NIT - This			
	NIT - Other			
<b>Time</b>				
	TOT			
<b>EPG</b>				
	This TS			
		SDT Actual		
		Service (number, name)		

Table 2-18: ISDB-S SI/PSI nodes (Cont.)

Primary node	Subsidiary node 1	Subsidiary node 2	Subsidiary node 3	Subsidiary node 4
			Now/Next (EIT P/F)	
			Basic Schedule (EIT schedule)	
			Extended Schedule (EIT schedule)	
	Other TS			
		SDT Other		
		Service (number, name)		
			Now/Next (EIT P/F)	
			Basic Schedule (EIT schedule)	
			Extended Schedule (EIT schedule)	
	Maker id/model id +			
<b>Other tables</b>				

Table 2-19: ISDB-T SI/PSI nodes

Primary node	Subsidiary node 1	Subsidiary node 2	Subsidiary node 3	Subsidiary node 4
<b>TS info</b>				
	Partial TS			
		DIT		
		SIT		
	BIT			
<b>Programs</b>				
	PAT			
	PMT PIDs			
	SDT			
<b>Conditional access</b>				
	CAT			
<b>Networks</b>				
	NIT - This			
	NIT - Other			
<b>Time</b>				

**Table 2-19: ISDB-T SI/PSI nodes (Cont.)**

Primary node	Subsidiary node 1	Subsidiary node 2	Subsidiary node 3	Subsidiary node 4
	TOT			
<b>EPG</b>				
	This TS			
		SDT Actual		
		H		
			Service (number, name)	
				Now/Next (EIT P/F)
				Basic Schedule (EIT schedule)
				Extended Schedule (EIT schedule)
		M		
			Service (number, name)	
				Now/Next (EIT P/F)
				Basic Schedule (EIT schedule)
				Extended Schedule (EIT schedule)
		L		
			Service (number, name)	
				Now/Next (EIT P/F)
				Basic Schedule (EIT schedule)
				Extended Schedule (EIT schedule)
<b>SDTT</b>				
	SDTT(H)			
		Maker id/model id +		
	SDTT(L)			
		Maker id/model id +		
<b>Other tables</b>				





# **Packetized Elementary Stream Analyzer**



# Table of Contents

<b>Getting Started</b> .....	<b>3-1</b>
Starting the Program .....	3-2
Options .....	3-5
Opening a File .....	3-8
<b>Menus and Controls</b> .....	<b>3-11</b>
Toolbar .....	3-11
Status Bar .....	3-13
Slider Bar .....	3-14
Menus and Options .....	3-17
<b>Packet Hex View</b> .....	<b>3-21</b>
Packet Header .....	3-22
<b>Event Log</b> .....	<b>3-25</b>
Packet Selection .....	3-25
<b>Packet Header Interpretation</b> .....	<b>3-29</b>
<b>Program Structure</b> .....	<b>3-33</b>
The Diagram .....	3-34
Selecting a Packet Type .....	3-35
<b>PTS/DTS Timing Analysis</b> .....	<b>3-37</b>
Access Unit Selection .....	3-40
Scrolling the View .....	3-40
Video Streams .....	3-41
Audio Streams .....	3-43
AC-3 Audio Streams .....	3-45
AAC Audio Streams .....	3-46

## List of Tables

<b>Table 3-1: File menu options</b> .....	<b>3-3</b>
<b>Table 3-2: View menu options</b> .....	<b>3-4</b>
<b>Table 3-3: Settings menu options</b> .....	<b>3-4</b>
<b>Table 3-4: Options menu options</b> .....	<b>3-4</b>
<b>Table 3-5: File menu options</b> .....	<b>3-17</b>
<b>Table 3-6: Edit menu options</b> .....	<b>3-17</b>
<b>Table 3-7: View menu options</b> .....	<b>3-18</b>
<b>Table 3-8: Options menu options</b> .....	<b>3-18</b>
<b>Table 3-9: Window menu options</b> .....	<b>3-18</b>
<b>Table 3-10: Help menu options</b> .....	<b>3-19</b>

# Getting Started

The Packetized Elementary Stream (PES) Analyzer performs a series of user selectable conformance tests on a previously recorded file. Files can be interpreted according to either the ATSC or DVB standards. Once the file is analyzed analyzed users can view the results of the selected tests and browse through the content of the PES packets.

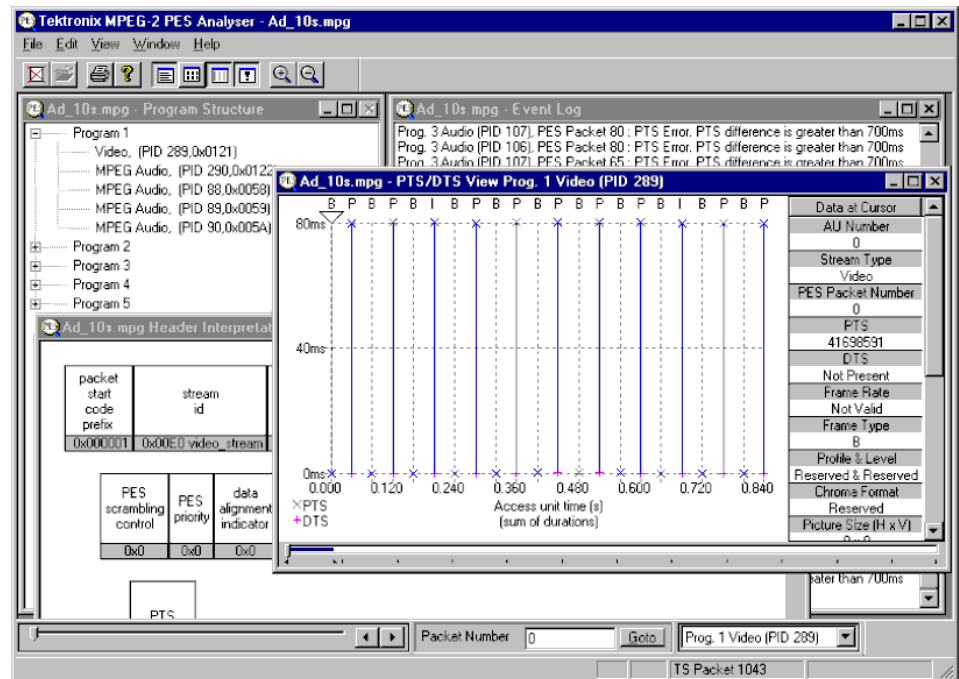

Information can be viewed in graphical and textual formats. To analyze and view the Transport Stream packets, use the companion program TS Analyzer, which can be run at the same time as this PES Analyzer.

The functionality provided includes:

- Display of program structure showing the programs contained within the transport multiplex and the PES streams which make up each program.
- Display an interpretation of PES packet for individual packets.
- Hexadecimal representation of PES packet.
- Extraction and display of Presentation Time Stamp (PTS) and Decoding Time Stamp (DTS) information from the PES packet header.

- Display of access unit information for video and audio access units.

---

**NOTE.** The examples shown in this chapter are taken from both ATSC and DVB compliant transport streams. An example of each type is sometimes shown as a reminder that both standards are supported or where a difference needs explanation.

---

## Starting the Program

Start the program by selecting the Tektronix PES Analyzer option from the Start > Programs menu or by double clicking on the Tektronix PES Analyzer shortcut on the desktop.

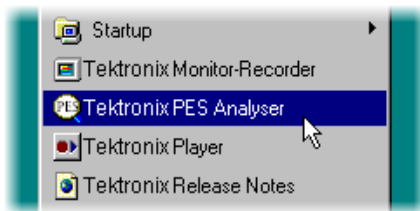

## Initial Appearance

Once the program has started and is ready for use it will open a Main Window. When the program first starts it looks as follows:



The Toolbar (row of buttons above the dark gray area of the empty window) may be hidden from view, moved to a separate window or moved to either side or the bottom of the main window.

The Status Line at the very bottom of the window may be hidden from view. Because no file is open, it is displaying a message that the TS packet number is Not Valid.

Above the Status line is the Slider Bar. This has three groups of controls for selecting streams and packets within a file. This may be moved to the top of the window.

### Initial Menu Options

PES Analyzer presents different menus and options, depending on whether or not a file is open for analysis. The menu options available when no file is open, are as follows:

---

**NOTE.** A check mark next to an option indicates that the window or toolbar is currently visible or enabled, no check mark means that it is hidden or disabled.

---

**File Menu Options.** The File menu contains the menu options listed in Table 3–1.

**Table 3–1: File menu options**

Command	Function
Open...	Opens an MPEG file for analysis. The program opens the file selection dialog allowing the user to choose the required file.
Print Setup ...	Opens a dialog for selecting which printer and associated options to use.
1 <filename> 2 <filename> 3 <filename> 4 <filename>	A list of the four most recently analyzed files. If the program has recently been installed the list may be empty or hold less than four files.  Selecting a filename opens that file for analysis.
Exit	Finishes running the program.

**View Menu Options.** The View menu contains the menu options listed in Table 3–2.

**Table 3–2: View menu options**

Command	Function
Toolbar	Displays or hides the toolbar.
Status Bar	Displays or hides the status bar.

**Settings Menu Options.** The Settings menu contains the menu options listed in Table 3–3.

**Table 3–3: Settings menu options**

Command	Function
Test Options	Opens a dialog for setting the Conformance Test Options for analyzing and interpreting the PES information in stream files.

**Options Menu Options.** The Options menu contains the menu options listed in Table 3–4.

**Table 3–4: Options menu options**

Command	Function
Limit Repeat Errors	Lists the first 20 occurrences of each error type in the event log.



## Options

The MPEG and ATSC Conformance Test Options for MPEG and ATSC may not be modified when a file is open. To change them, all files must be closed, the test options modified, and the file opened again.

Select Test Options from the Settings menu to open the Conformance Tests dialog.

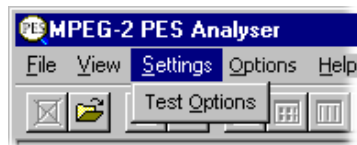

---

**NOTE.** *The Settings Menu is only available when there is no file open. It is hidden when a file is opened and redisplayed when the file is closed.*

---

### Conformance Tests

The dialog box contains two tabbed pages containing tests relating to MPEG and ATSC files, respectively. Note that the MPEG tests are sufficient for DVB streams.

**Test of PES Header Syntax (MPEG).** The tests of PES header Syntax are based on the conformance requirements laid down in the standards document ISO/IEC 13818-4 for Packetized Elementary Streams. Each check box uses the same name for a particular test as the standard. For example, to test conformance to the standard for the length of PES packets select the PES\_packet\_length option.

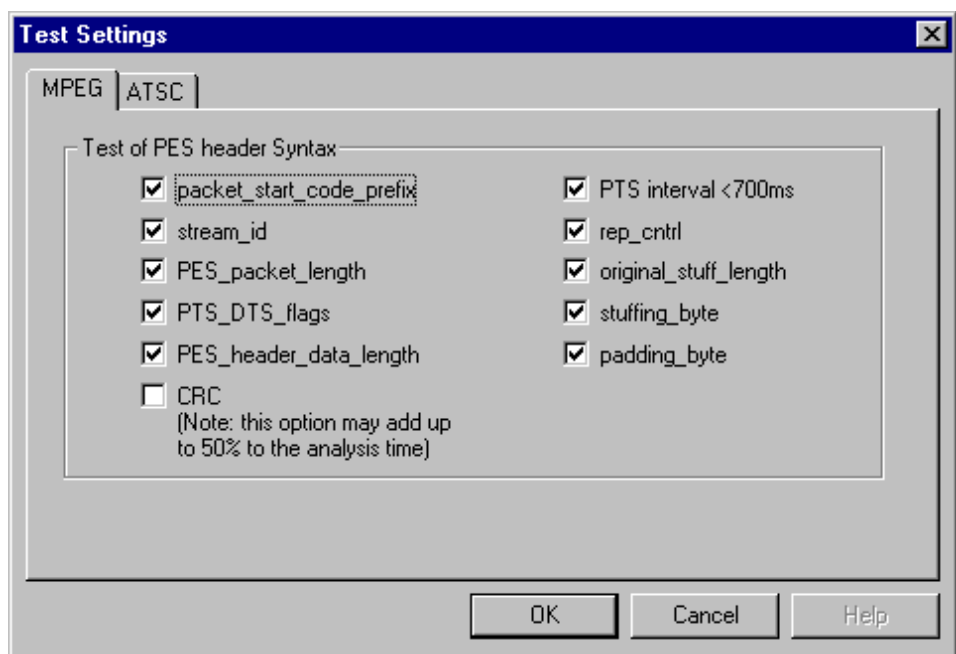

A check mark shows that a test is selected and an empty check box indicates that the test will not be performed.

**Test of PES Header Syntax (ATSC).** When the ATSC Stream box is checked, selected streams are interpreted according to the ATSC standards, A/52 and A/53.

A check mark shows that a test is selected and an empty check box indicates that the test will not be performed.

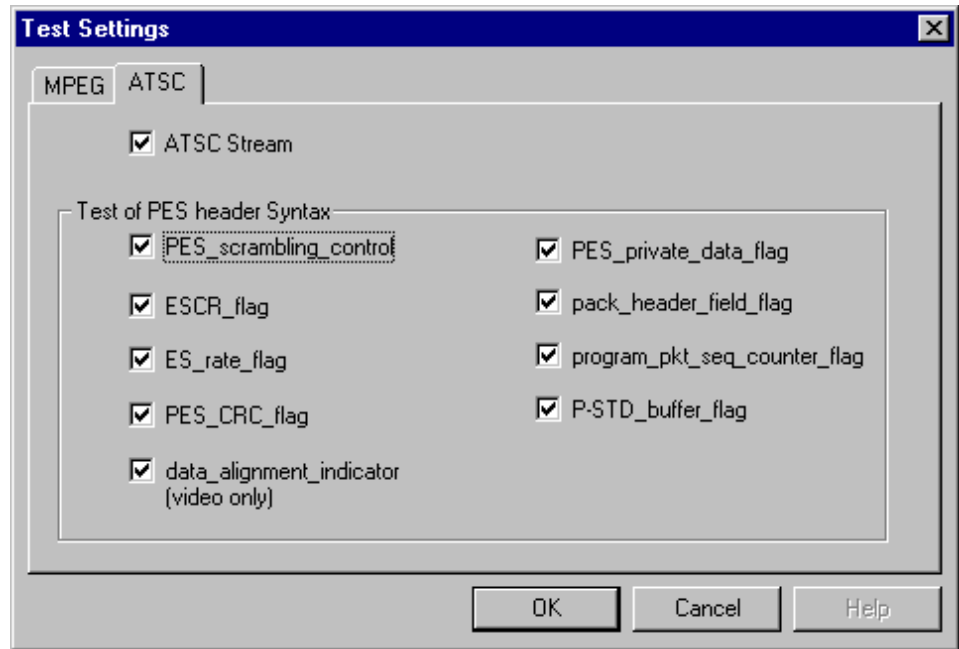

For streams in a DVB standard stream, leave the ATSC Stream option unchecked. The ATSC Stream option is disabled (grayed out) if the software license is only for the DVB standard.

## Opening a File

Any file holding a recorded or synthesized sample of a stream can be opened for PES Analysis by this program. To analyze the Transport Stream packets, open the file in the TS Analyzer. A file can be opened by both the TS and PES Analyzers at the same time.

### Opening a File from the Menus and Toolbar

To open a file select the Open... option from the file menu. If the required file is in the list of recently analyzed files then it can be opened from the list to save using the Open file dialog. Alternatively, use the Ctrl+O keyboard shortcut.

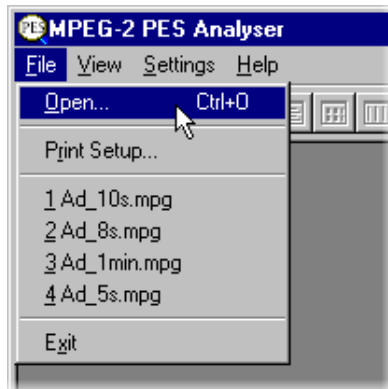

There is also a shortcut button available on the Toolbar for opening a file, which has the standard file open symbol:



Once a file is open this button will be disabled, which is shown by being “grayed out”.

## Window Layout

Program Structure and Event Log windows are opened as soon as the file is opened. The layout of the windows will have been saved from the last time the program was used. If the program has just been installed, the windows will be in the application default Cascade arrangement, which looks like this:

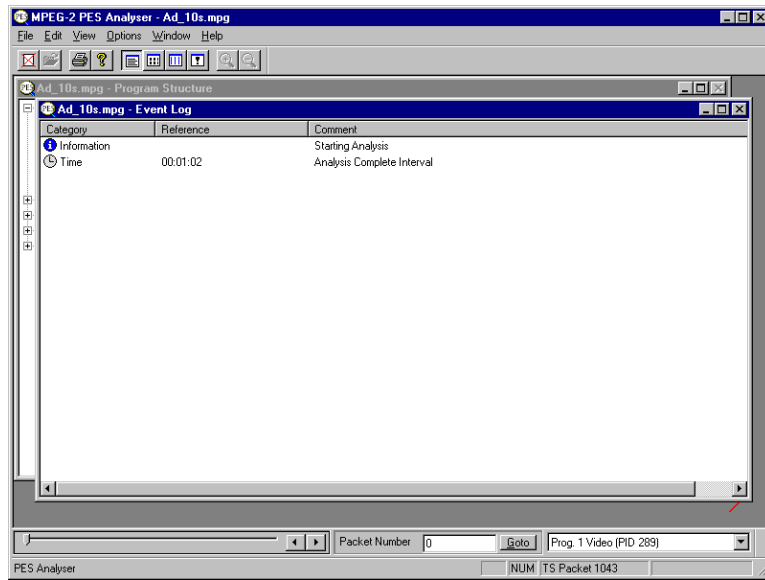

Many users rearrange the windows so that the Program Structure and Event Log windows do not overlap. The examples in this manual often use this arrangement:

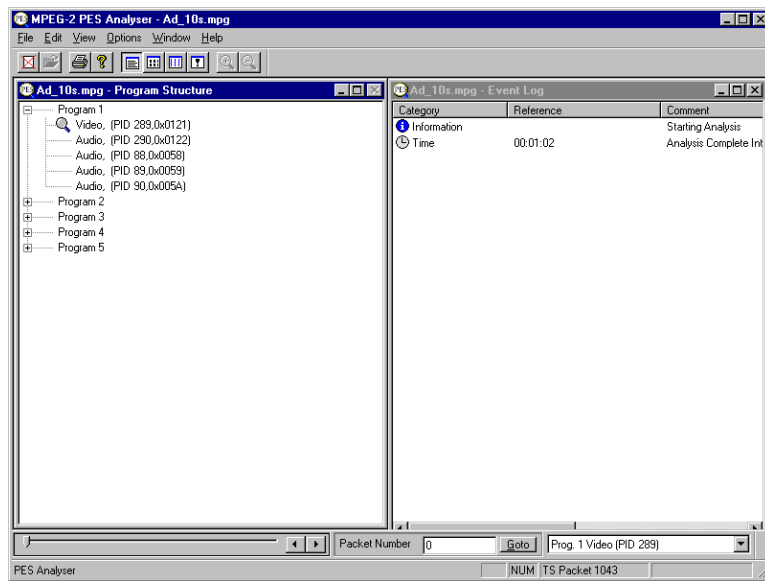

**NOTE.** The above example is from a transport stream interpreted and labeled according to the DVB standard. If the ATSC Stream option is set the elementary streams will be interpreted and labeled according to the ATSC standard. For example: audio streams would be labeled AC-3 Audio, instead of Audio or AAC Audio.

### PES Analysis

The PES Analyzer program now starts to analyze the file for conformance to the selected tests. Due to the very efficient algorithms used by the program, it will analyze large files in a few minutes. Other algorithms have been seen to take much longer. The rightmost pane in the Status Bar shows a progress indicator during Analysis.

As the file is analyzed messages are written in the Event Log and the structure diagram is drawn in the Program Structure window. When the processing is done an “Analysis Complete” message is written in the Event Log.

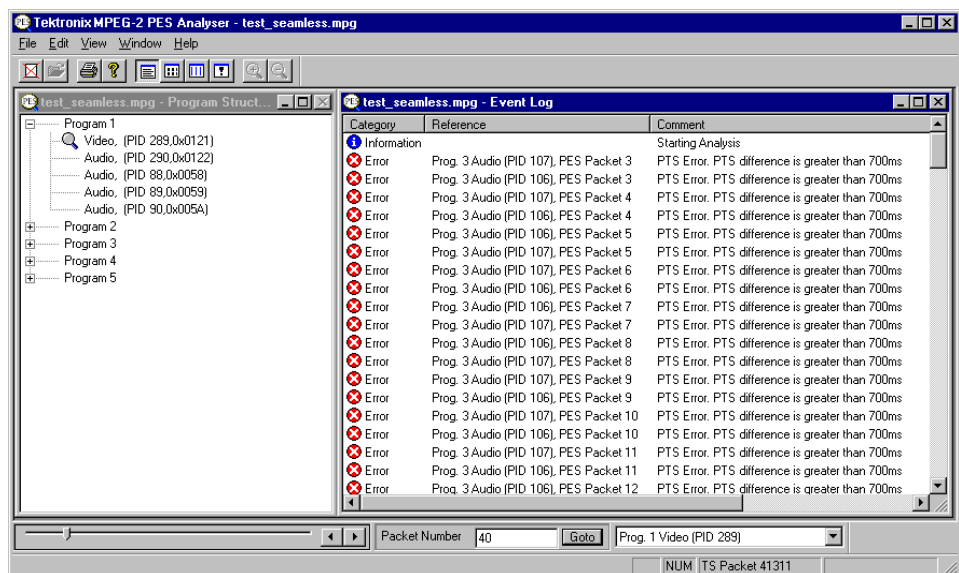









# Menus and Controls

When a file is open the program presents a different set of menus and options. They change as soon as the Program Structure and Event Log windows appear. For example, the Open file commands are replaced by Close file commands.

## Toolbar



The Toolbar provides a set of convenient shortcuts for the more frequently used menu options. The available commands are:

-  Closes the current file. This button becomes enabled the moment a file is opened and analysis starts. If the wrong file is being opened, or the wrong options are selected, clicking on the button will abandon the analysis and close the file.
-  Open a file. This button is disabled when a file is open.
-  Print the contents of the current window.
-  Opens a dialog which displays the program version number.
-  Toggles the Event Log window. When the button is in this state the window is not visible and clicking on the button will open the Event Log.
-  Toggles the Packet Hex View window. When the button is in this state the window is not visible and clicking on the button will open the Hex View.
-  Toggles the PTS/DTS View window. When the button is in this state the window is not visible and clicking on the button will open the PTS/DTS View.
-  Toggles the Header Interpretation window. When the button is in this state the window is not visible and clicking on the button will open the Header Interpretation.



Zoom In on data in the PTS/DTS View. This button is only enabled when the PTS/DTS View is the current window.



Zoom Out from the data in the PTS/DTS View. This button is only enabled when the PTS/DTS View is the current window.

The Toolbar can be dragged off the edge of the main window into a floating pallet. To do this click on the background inside the Toolbar, that is, not on one of the buttons, and drag into the main window area. The result is a self-contained window which looks like this:



To replace the Toolbar on the window border drag it over the border until the outline changes shape. It can be placed on the top, bottom, left or right edges.



## Status Bar



The Status Bar may be hidden from view, but if visible is always at the bottom of the main window. It displays the following information about the program and keyboard states:

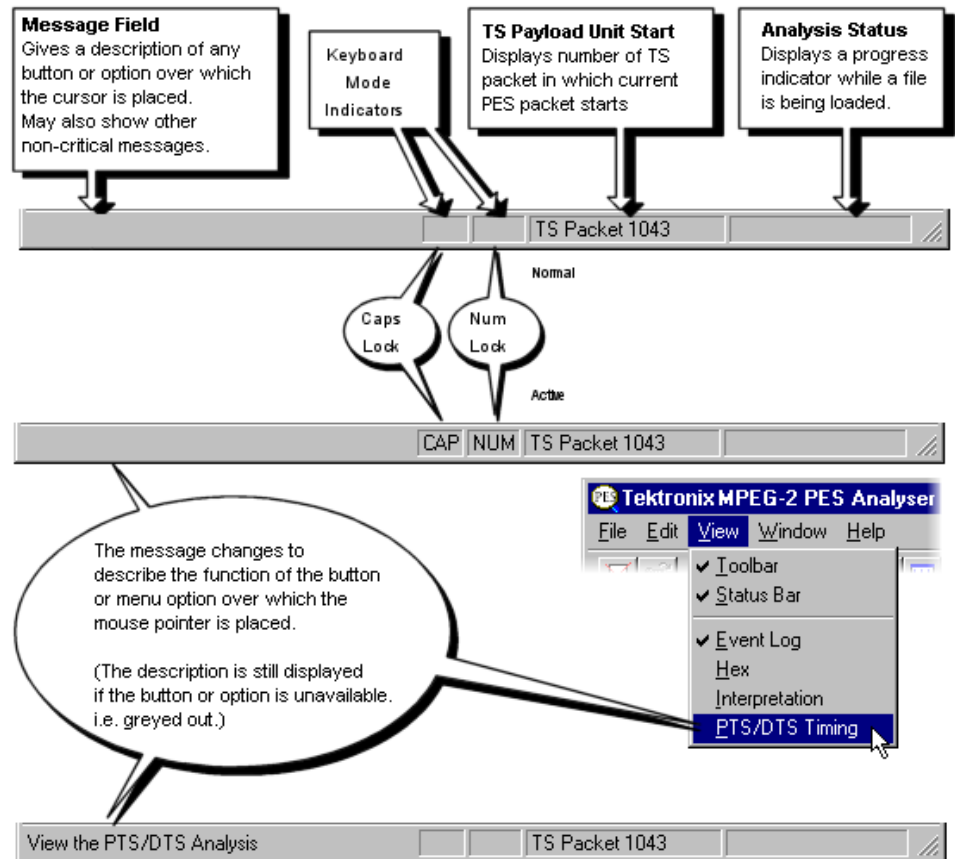

## Slider Bar

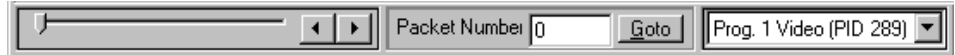

The Analyzer can display the contents of any PES packet in the currently loaded file. Packets are numbered, within a PID, according to their position in the file; the first PES packet of each PID being PES packet 0 (zero). The Slider Bar displays the packet number and the PID for the current packet.

The slider bar controls are as follows:

### Slider

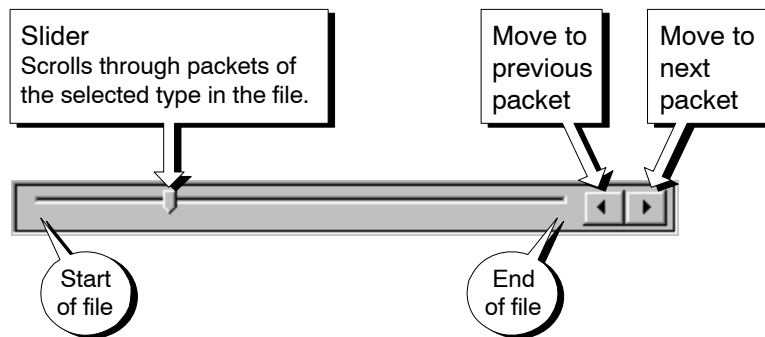

### Packet number

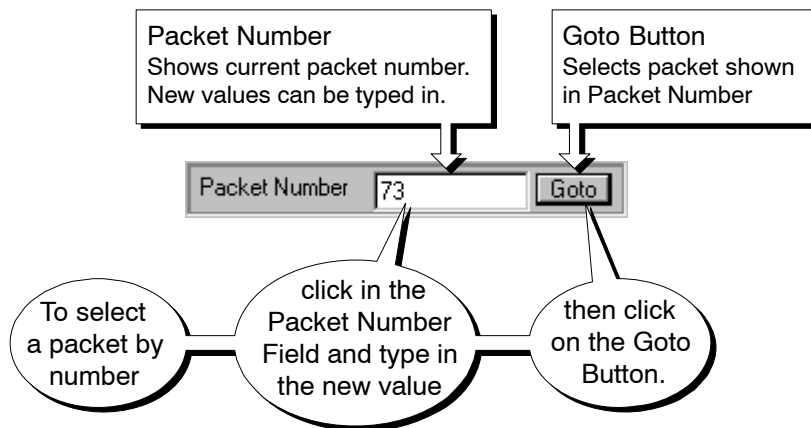

**Packet Type - Elementary Stream**

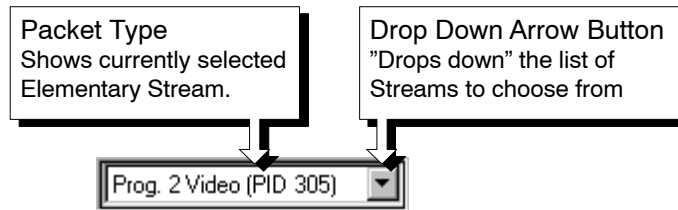

Like the Toolbar the Slider Bar can be dragged from the edge of the main window into a floating pallet; to do this click on the background inside the Slider Bar and drag it into the main window area. The result is a self contained window which looks like this:

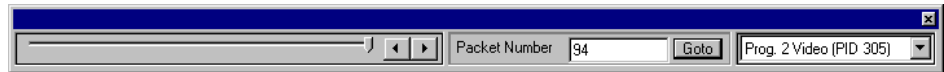

To replace the Slider Bar on the window border drag it over the border until the outline changes shape. Unlike the Toolbar it can only be placed on either the top or bottom edges.

### Selecting Packet Type

The Slider and Packet Number can only select packets in the currently selected program stream. The stream is indicated in the Packet Type drop-down list and by the magnifying glass symbol, , in the Program Structure window. A new stream may be selected from either the list box or the window.

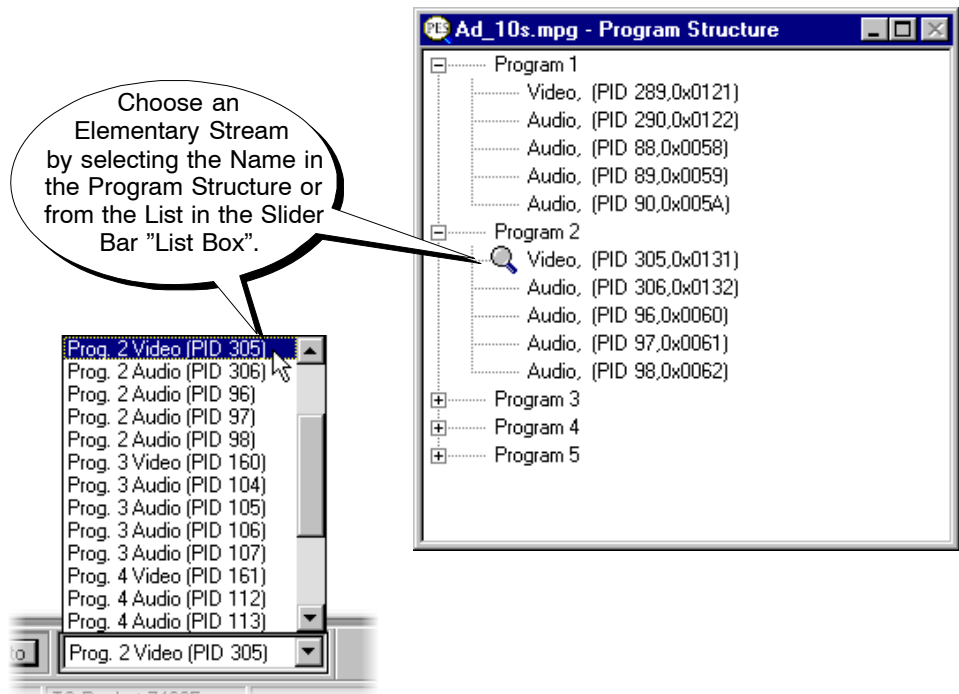

## Menus and Options

---

**NOTE.** A check mark next to an option indicates that the window or toolbar is currently visible or enabled, no check mark means that it is hidden or disabled.

---

**File Menu options**      The File menu contains the menu options listed in Table 3–5.

**Table 3–5: File menu options**

Command	Function
Close	Closes the current file. This option is available as soon as analysis starts. If the wrong file is being opened, or the wrong Conformance Tests are being run, selecting this option will abandon the analysis and close the file.
Print	Prints contents of the current window.
Print Setup	Selects printer and configuration.
Exit	Closes any file that is open and terminates execution the program.

**Edit Menu options**      The Edit menu contains the menu options listed in Table 3–6.

**Table 3–6: Edit menu options**

Command	Function
Copy	Copies the contents of the current window to the MS Windows™ Clipboard, from which it can be pasted into a document in another application.
Copy TS Packet	Allows the user to select an AU (access unit) within the PES Analyzer, and then copy the TS packet number onto the Windows clipboard. The Stream Analyzer may then be started and Paste TS packet selected to go to the packet number retrieved from the clipboard.

**View Menu options**     The View menu contains the menu options listed in Table 3–7.

**Table 3–7: View menu options**

Command	Function
Toolbar	Shows or hides the Toolbar, which provides a set of convenient shortcuts for the more frequently used menu options.
Status Bar	Shows or hides the Status Bar.
Event Log	Shows or Hides the Event Log.
Hex	Shows or Hides the Hex View.
Interpretation	Shows or Hides the Packet Interpretation view.
PTS/DTS Timing	Shows or Hides the PTS/DTS Timing Analysis window.

**Options Menu options**     The Options menu contains the menu options listed in Table 3–8.

**Table 3–8: Options menu options**

Command	Function
Limit Repeat Errors	Only lists the first 20 occurrences of each error type in the event log.

**Window Menu options**     The Window menu contains the menu options listed in Table 3–9.

**Table 3–9: Window menu options**

Command	Function
Cascade	Arranges all the windows so that they are neatly stacked; only the title bars show behind the active window.
Tile	Reduces and moves windows so that they can all be seen at once.
Arrange Icons	Aligns icons of any minimized windows at the bottom of the program’s main window.
1 <window title> 2 <window title> 3 ... etc.	Makes the named window active, putting it on top of any windows which had been hiding all or part of it.

**Help Menu options**     The Help menu contains the menu options listed in Table 3–10.

**Table 3–10: Help menu options**

<b>Command</b>	<b>Function</b>
About PES Analyzer...	Opens a dialog that displays the program version number.





# Packet Hex View

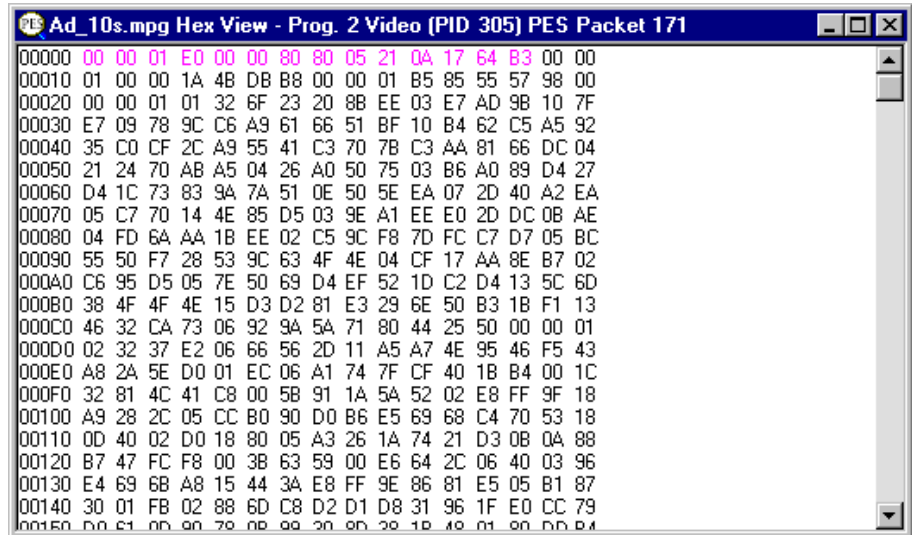

This is the lowest level view of the PES Packet data. It displays the contents of every byte in hexadecimal. Each byte is represented as a pair of hexadecimal digits. The window may be resized to display 16, 32, 48, ... bytes of information on each row.

The four digit numbers in the left most column are the addresses of the first (that is, leftmost) byte in the row. The addresses are shown in hexadecimal.

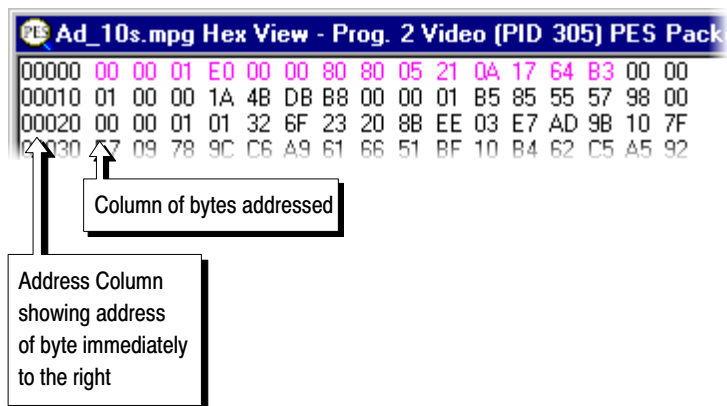

## Packet Header

The Hex View displays the bytes holding PES Packet header information in magenta color text. For example here is a packet containing a PTS field, from a video stream:

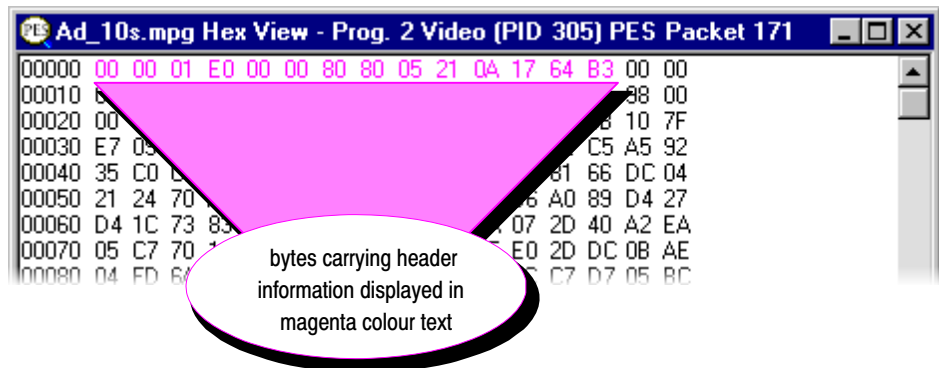

The most significant two bits of the eighth byte (that is, the byte at address 0x0007) contain the PTS\_DTS\_flags. The ninth byte (address 0x0008) contains the PES\_header\_data\_length, which specifies how many additional bytes are present. In the above example:

PTS\_DTS\_flag = 2

PES\_header\_data\_length = 5

These specify that there is a 5 byte Presentation Time Stamp (PTS) field in the header. The contents of the PTS are 21 0A 17 64 B3 and they follow the PES\_header\_data\_length.

The preceding packet, from the same stream, carried both a PTS and DTS field:

PTS\_DTS\_flag = 3

PES\_header\_data\_length = 10 (shown as 0A in hexadecimal)

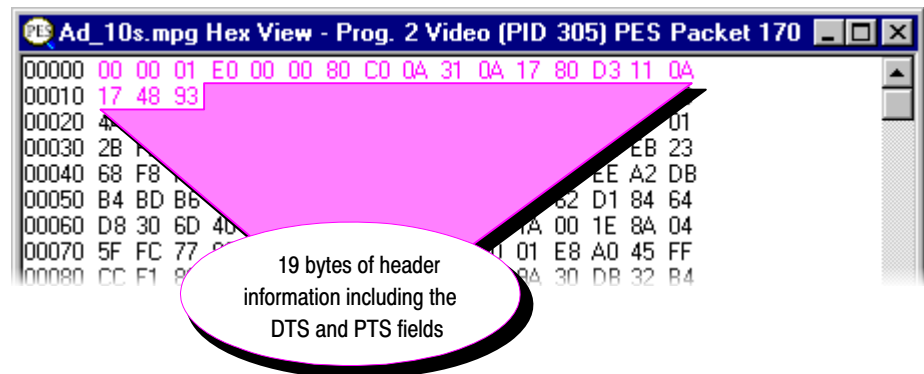

Instead of having to interpret header information from the Hex View, the PES Analyzer provides the Header Interpretation window. This interprets the header and displays the contents, in table form, according to the MPEG-2 standards.



# Event Log

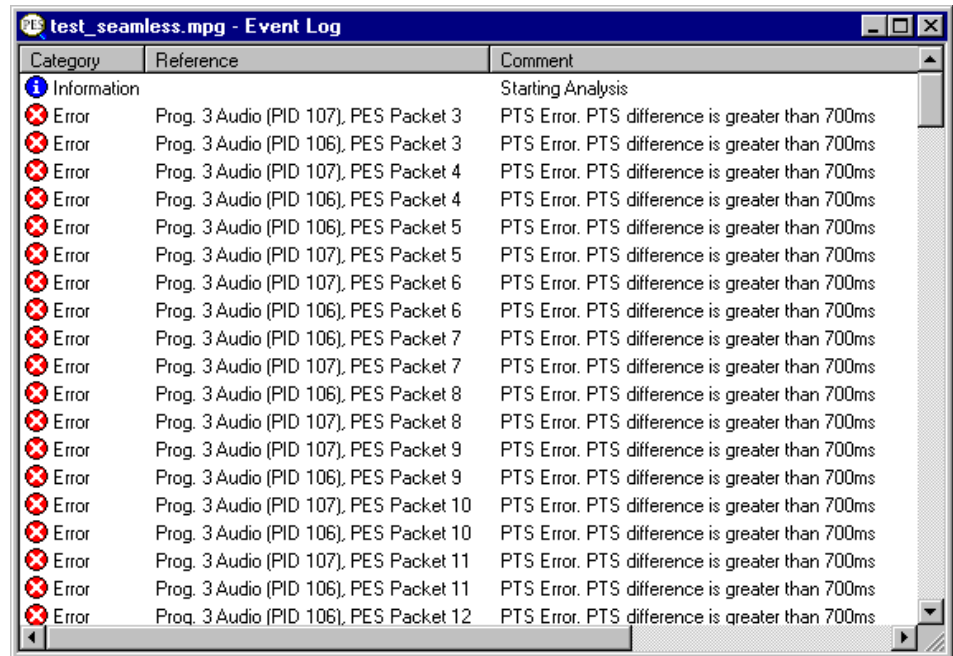

The program always opens the Event Log window when it starts to analyze a file. As the file is analyzed the program writes the results to the window as they are produced. When processing finishes an “Analysis Complete” message is appended to the report.

## Packet Selection

If a warning or error message gives a packet number, that packet may be inspected by selecting the message. For example, here is an extract from a file with PTS errors on two of the Audio streams:

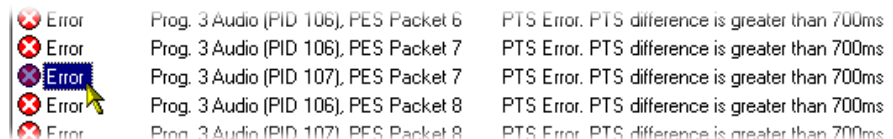

Clicking on the message for Prog. 3 Audio (PID 106), PES Packet 78 selects both the program stream and the packet. This is reflected by the Slider Bar, in the Program Structure, Hex View, Header interpretation and PTS/DTS Views.

The Slider bar will look like this:



In the program structure view, the magnifying glass icon, , appears on the selected stream:

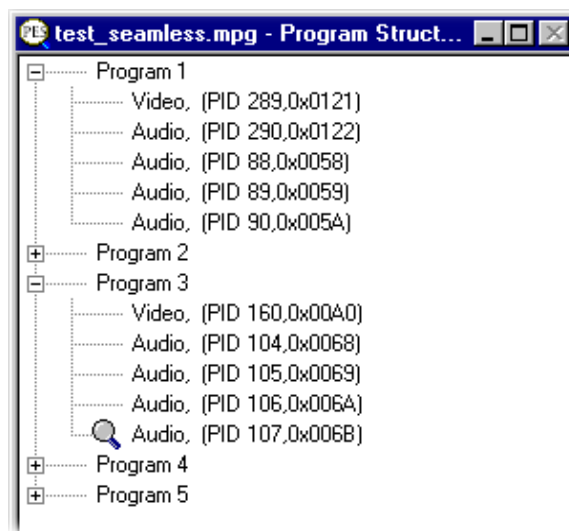

If the Hex View and/or Header Interpretation windows are open they will be updated to show the contents of the selected packet. If the PTS/DTS View window is open the cursor is placed on the packet and the panel showing the Data at Cursor is updated.

Having selected the packet it can now be inspected with other tools. The information in the Header Inspection and Hex View windows will look like this:

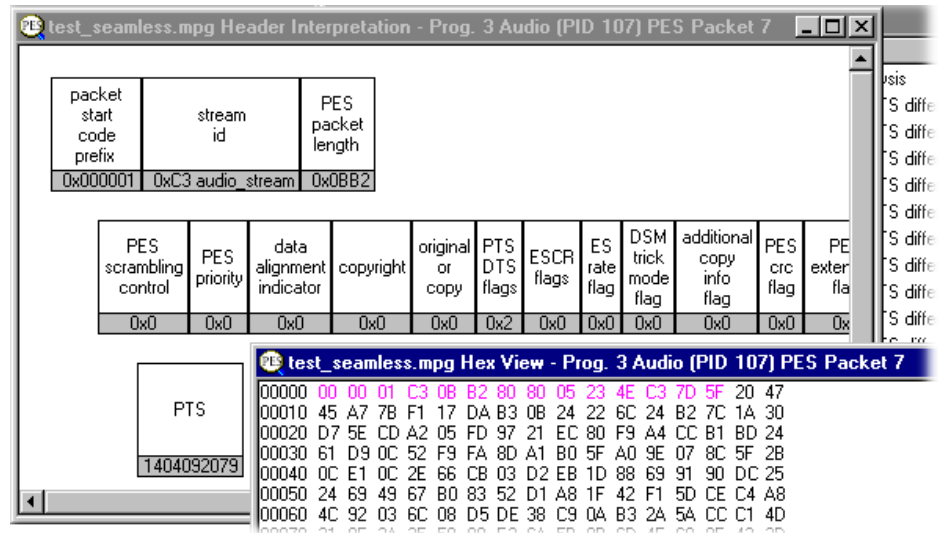

To look at the timing of all the PTS carrying packets, open the PTS/DTS View:

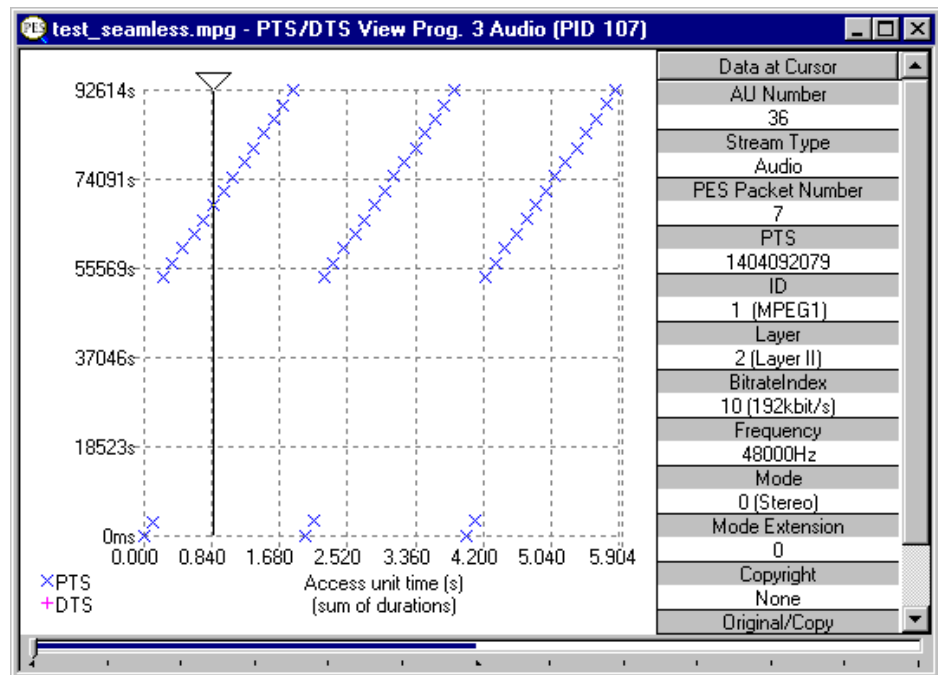

This shows all the PES packets for the selected PID. See the section on the PTS/DTS View for more information on selecting a particular packet.





# Packet Header Interpretation

packet start code prefix	stream id	PES packet length
0x000001	0x00E0 video_stream	0x00

PES scrambling control	PES priority	data alignment indicator	copyright	original or copy	PTS DTS flags	ESCR flags	ES rate flag	DSM trick mode flag	additional copy info flag	PES crc flag	PES extension flag	PES header data length
0x0	0x0	0x0	0x0	0x0	0x2	0x0	0x0	0x0	0x0	0x0	0x0	0x5

PTS

42316377

PES packet data bytes

This window interprets and displays the header of the currently selected packet. The above example shows a packet which carries a Presentation Time Stamp (PTS).

The relationship between the top row of information displayed in the Header Interpretation, for this packet, and the Hex View is:

packet start code prefix	stream id	PES packet length
0x000001	0x00E0 video_stream	0x00

Ad\_10s.mpg Hex View - Prog. 2 Video (PID 305) PES Packet 171

```

00000 00 00 01 E0 00 00 80 80 05 21 0A 17 64 B3 00 00
00010 01 00 00 1A 4B D8 B8 00 00 01 B5 85 55 57 98 00
  
```

The diagram shows a pink trapezoidal shape pointing downwards from the header fields to the corresponding hex values in the Hex View window. The top row of the Hex View (00000 00 00 01 E0 00 00 80 80 05 21 0A 17 64 B3 00 00) is highlighted in pink, indicating its correspondence to the header fields above it.

The next row completes the compulsory header information. The mapping between the Header Interpretation and Hex View is:

PES scrambling control	PES priority	data alignment indicator	copyright	original or copy	PTS DTS flags	ESCR flags	ES rate flag	DSM trick mode flag	additional copy info flag	PES crc flag	PES extension flag	PES header data length
0x0	0x0	0x0	0x0	0x0	0x2	0x0	0x0	0x0	0x0	0x0	0x0	0x5

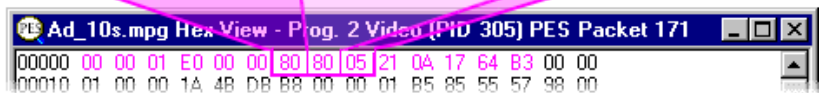

The last row is a reminder that after the header comes the packet data. Any other rows represent additional fields, such as the Presentation Time Stamp (PTS) carried in this example. The relationship of these rows to the Hex view is:

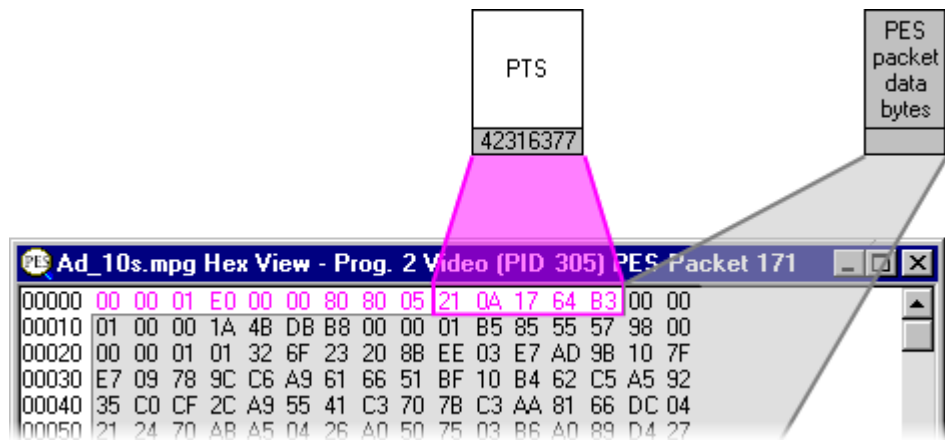

The size of the header depends on the fields it carries. Here is the Header Information view of the preceding packet which carries PTS and DTS fields:

packet start code prefix	stream id	PES packet length
0x000001	0x00E0 video stream	0x00

PES scrambling control	PES priority	data alignment indicator	copyright	original or copy	PTS DTS flags	ESCR flags	ES rate flag	DSM trick mode flag	additional copy info flag	PES crc flag	PES extension flag	PES header data length
0x0	0x0	0x0	0x0	0x0	0x3	0x0	0x0	0x0	0x0	0x0	0x0	0xA

PTS	DTS
42319977	42312777



# Program Structure

The Program Structure window displays a list of all available programs and the elementary streams that they contain. It shows which stream is currently selected for inspection and may be used to select a different stream.

The example below shows a program structure from a file conforming to the ATSC standard.

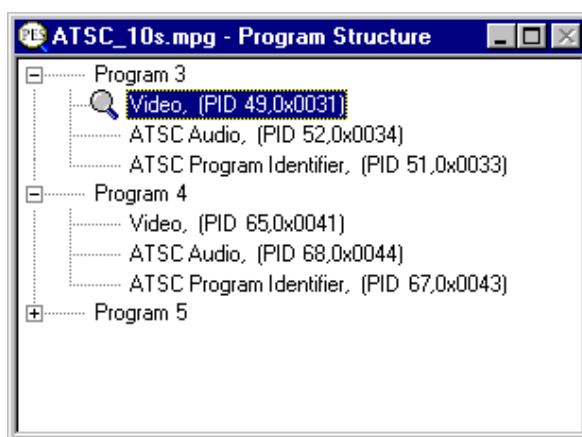

The example below is a program structure from a file that is compliant to the DVB standard.

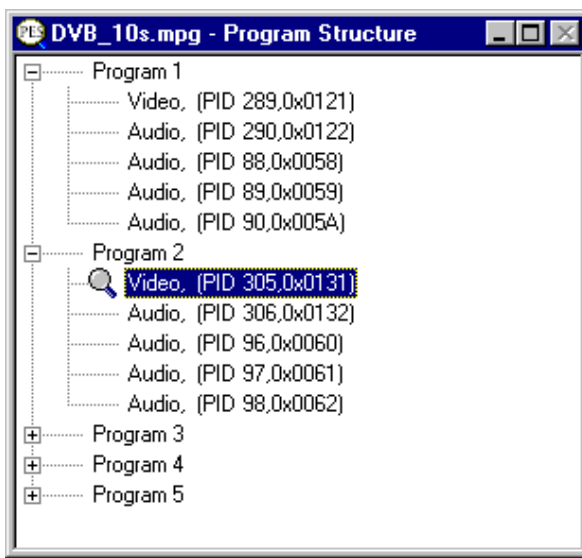

## The Diagram

The Program Structure is displayed by the program as soon as a file is opened. As the file is analyzed, the top levels of a structure diagram are drawn in the window:

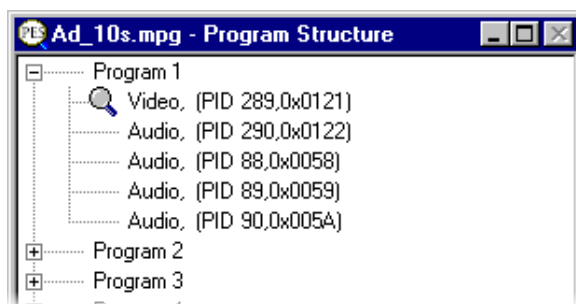

An Elementary Stream is selected by default. The Program Structure view shows the selected stream and other streams in the same program. The first program is expanded to show the streams in the next level.

Streams in the other programs are initially hidden from view.

The structure is represented by a tree diagram, with the “root node” or highest level component at the top. Components which contain more information beneath them in the structure are indicated by a square box.

Components that are connected to a branch of the tree without a square box are leaf nodes. In this case the Video and Audio elementary streams are leaf nodes. They display the lowest and finest level of detail.

Nodes can be expanded and contracted by clicking on the square box.

## Selecting a Packet Type

When a file is first opened and analyzed a stream will be selected by default. The type is indicated by the magnifying glass symbol, , in the Program Structure. It is also displayed in the Packet Type “list Box” on the Slider Bar. A new stream may be selected from either the list box or the window.

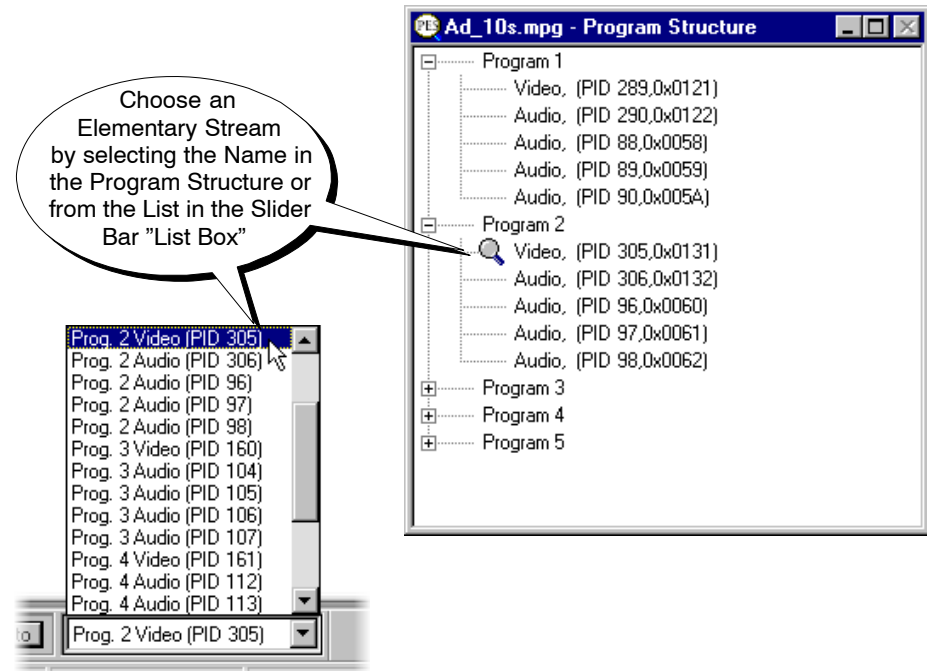





# PTS/DTS Timing Analysis

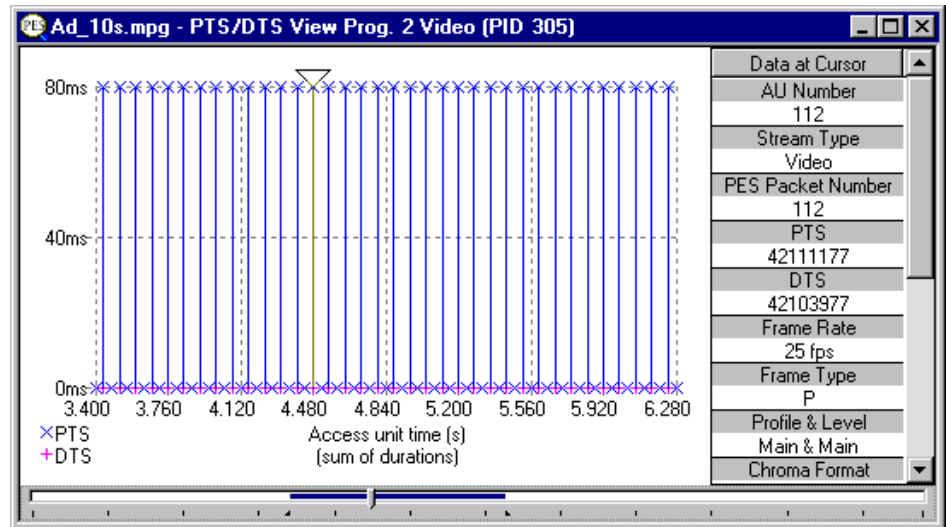

The PTS/DTS View shows timing analysis of the selected stream. The x-axis shows the duration of the stream in seconds. The y-axis shows the differences between the expected and actual DTS values. A vertical blue line is used to show the difference between the PTS and DTS for each Access Unit (AU). Therefore, a compliant stream will exhibit each DTS on the 0ms y-axis. Streams with errors usually exhibit a “stepped” graphical effect.

Any AU in the stream may be selected to view additional information in the panel on the right. If the panel is not tall enough to show all of the information a scroll bar appears.

When first opened the entire stream is shown. Even a small file may display data points packed too closely together to be read; for example, here is just under 12 seconds of video:

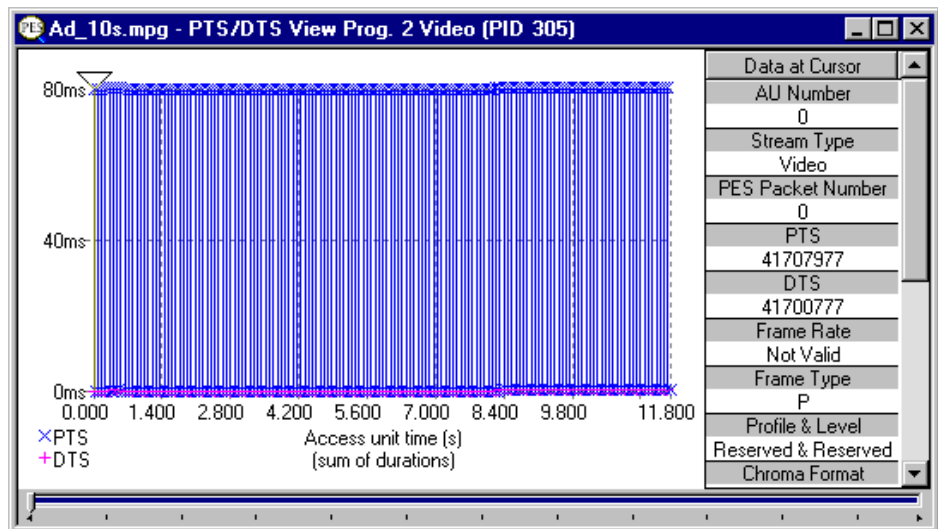

A longer sample may appear as a solid band of blue.

To see the individual packets or access units click on the Zoom In button on the Toolbar:



In this example, clicking the on the Zoom In button four times gave a much clearer view:

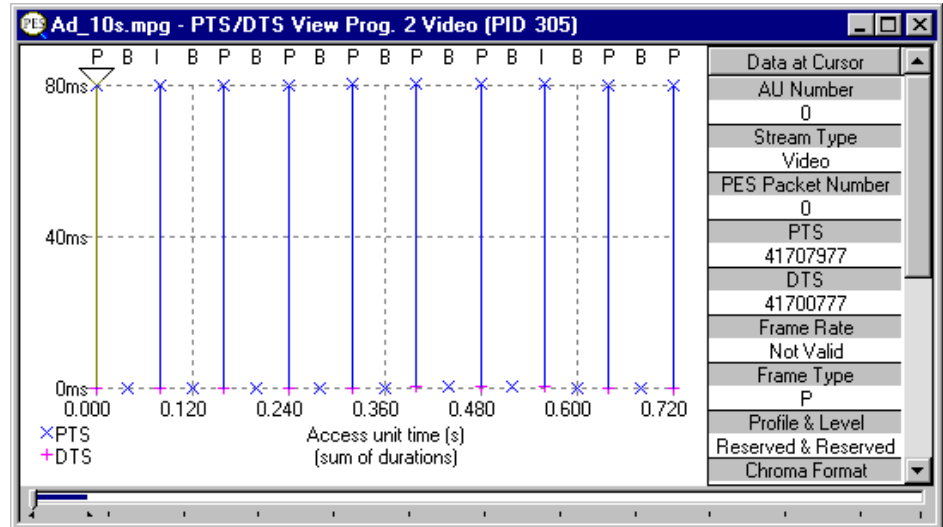

The blue X crosses of Presentation Time Stamps and the magenta + crosses of Decoding Time Stamps can now be differentiated.

To Zoom back out click on the Zoom Out button as many times as required:



## Access Unit Selection

The triangular cursor above the graph indicates the selected access unit. Extra information about that access unit is displayed in the Panel on the right of the Graph.

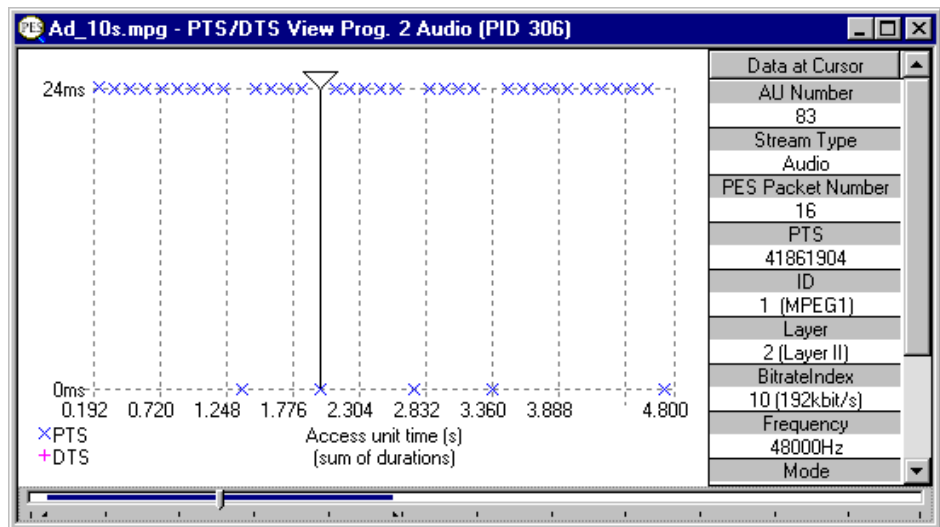

## Scrolling the View

The Slider at the bottom of the window indicates where the displayed packets / access units are in relation to the rest of the file. It can be used to scroll the display through the data in the same way as a standard window scroll bar.

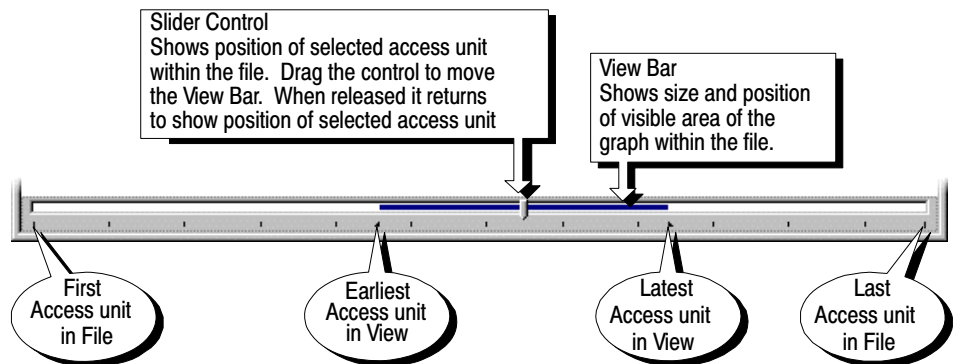

To scroll the stream through the view drag the Slider Control left or right with the mouse. After dragging the Slider Control it returns to the previous position showing the location of the selected access unit.

Click the mouse pointer on the white space either side of the View Bar to center the displayed graph about the currently selected access unit.

When an access unit is selected on the graph, the Slider Control is automatically repositioned within the View Bar. The placement of the Slider Control reflects the position of the selected packet in the field of view.

Selecting an Access Unit on the graph also changes the selection for all of the other views to the packet containing that Access Unit.

## Video Streams

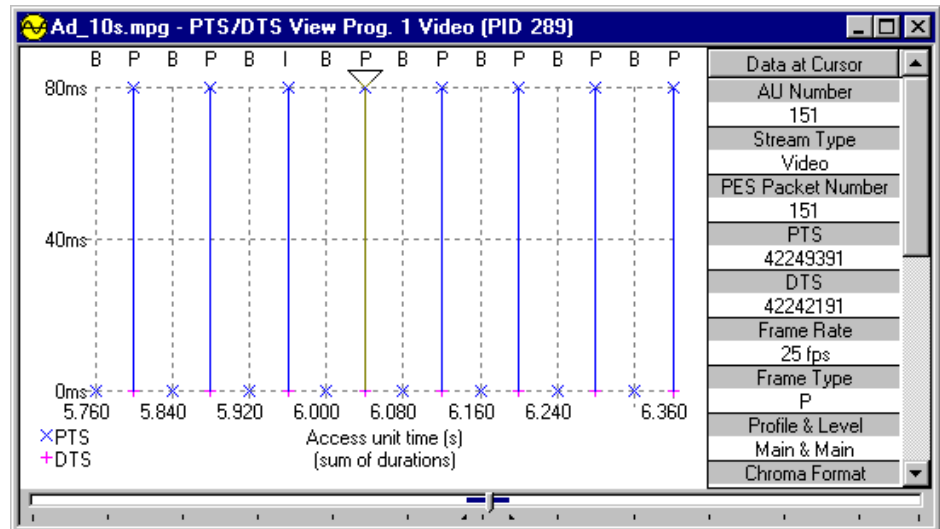

The panel on the right shows information about the selected access unit. For video streams these are always complete packets. Some of the information shown in the panel is specific to video streams, that is, frame rate and frame type.

The graph shows the frames of video in transmission order analysis and, when "Zoomed In" close enough, the type of each packet plotted along the x-axis. The graph scale is drawn in gray dashed lines. It is the equivalent of the scale or graticule on an oscilloscope or logic analyzer.

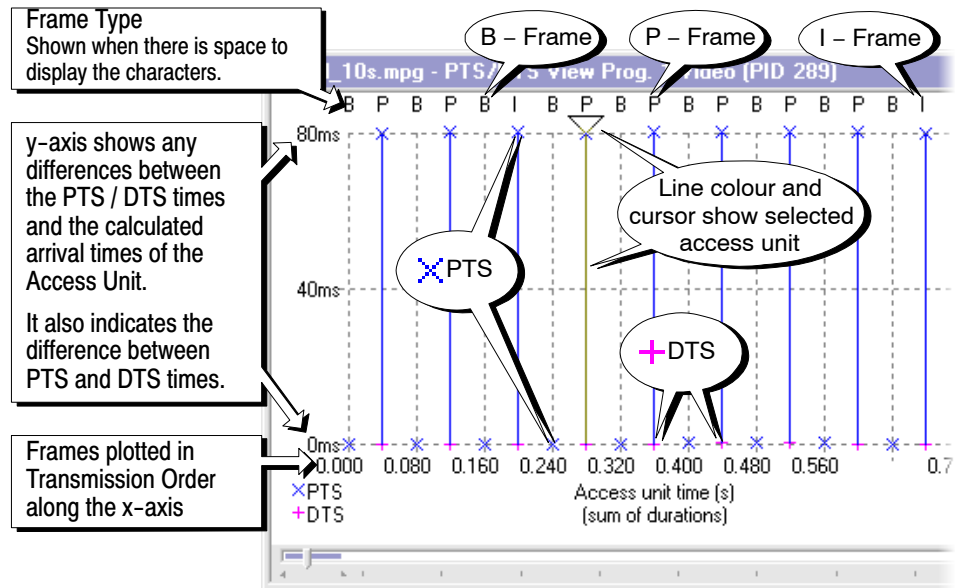

**X-Axis** The x-axis shows the nominal time of an access unit. The first access unit displayed is taken to have a nominal time of zero. Each access unit has a nominal duration, calculated from parameters within the elementary stream. These parameters include “low\_delay” and “repeat\_first\_field”, which allow analysis of effects such as 3:2 pulldown. These effects alter the access unit duration, which is nominally equal to a video frame period.

**Y-Axis** The position on the y-axis of a PTS or DTS shows the relative timing of the timestamps. The first timestamp (PTS, or DTS) is taken to have a y-value of zero. Each Subsequent timestamp has a y-value given by the difference between their timestamp and the first timestamp, less the difference in nominal time of their access unit and the first access unit.

The solid blue vertical lines show the time difference between the PTS and DTS from the same Access Unit.

## Audio Streams

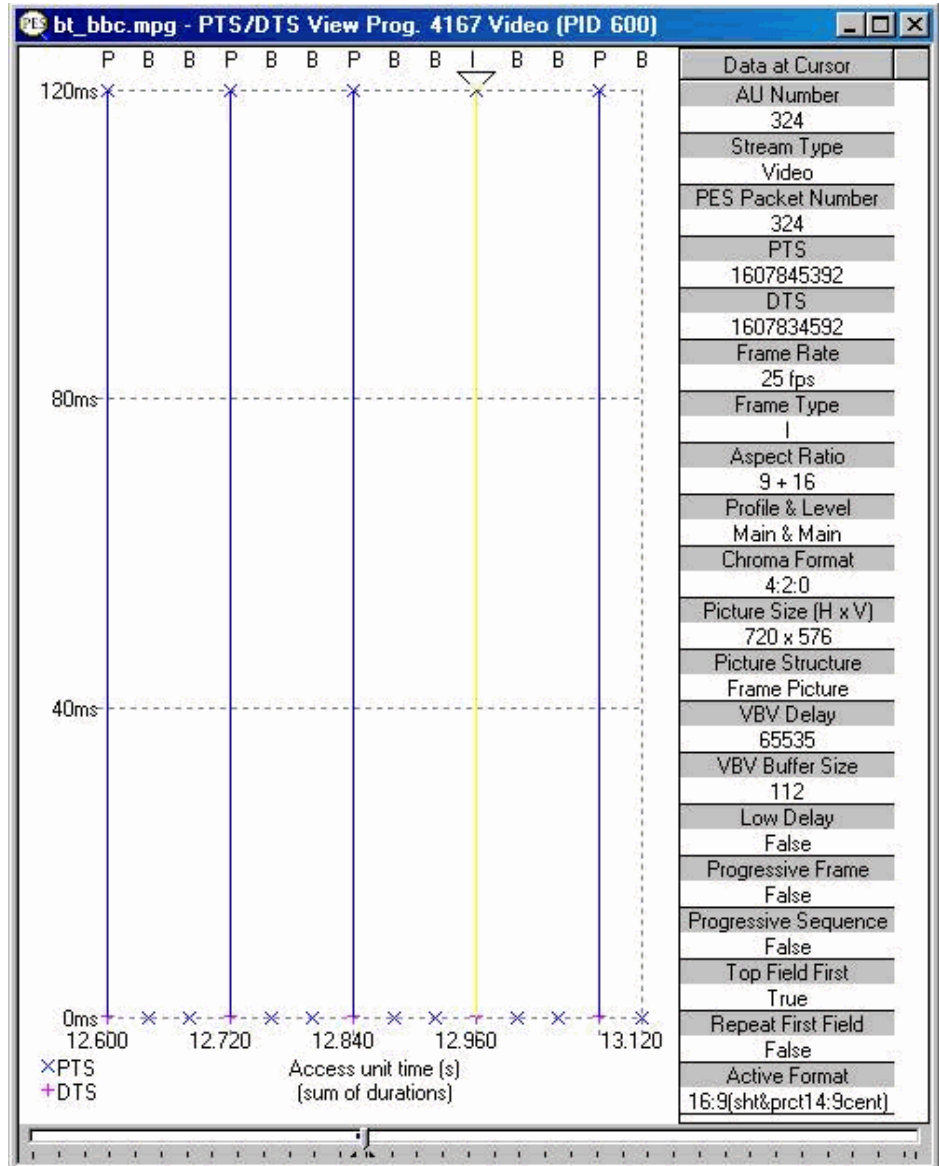

The panel on the right shows information about the selected access unit. For video streams, these are always complete packets. The frame rate and frame type shown in the panel are specific to video streams. The “Picture Size (H x V)” information is taken from the `display_horizontal_size` and `display_vertical_size` values in the sequence display extension. If that is not present, the `horizontal_size_value` and `vertical_size_value` values in the sequence header, as modified by the sequence header extension values `horizontal_size_extension` and `vertical_size_extension` in the sequence header extension are used.

Some of the information shown in the panel is specific to audio streams. AC-3 Audio streams will differ from Audio streams.

The graph shows timing analysis of the PTS. There are no DTS in an audio stream. Select an access unit by clicking on it with the mouse. Clicking between two PTS will select an access unit that does not carry a PTS.

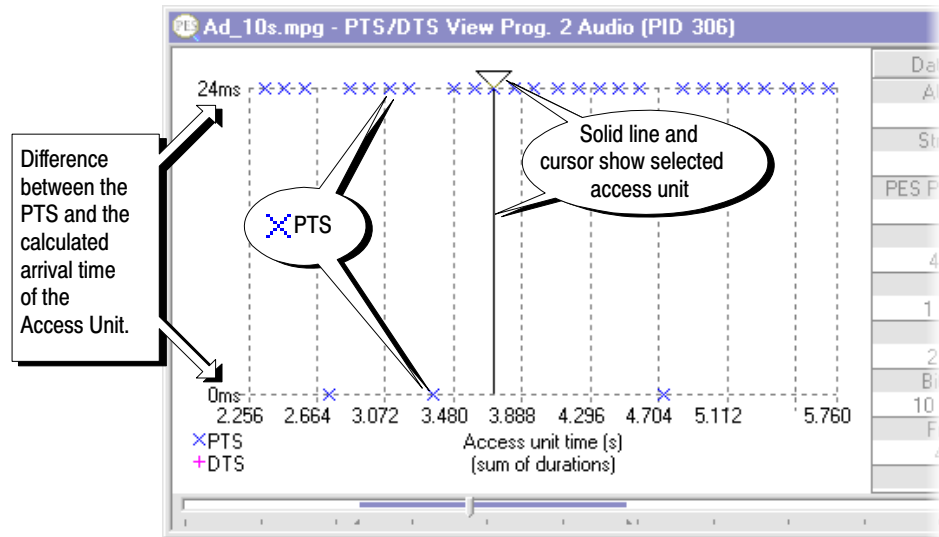

The graph scale is drawn in gray dashed lines for each value on the axis. In this example there are only two values on the y-axis, at 0 ms and 24 ms.



## AC-3 Audio Streams

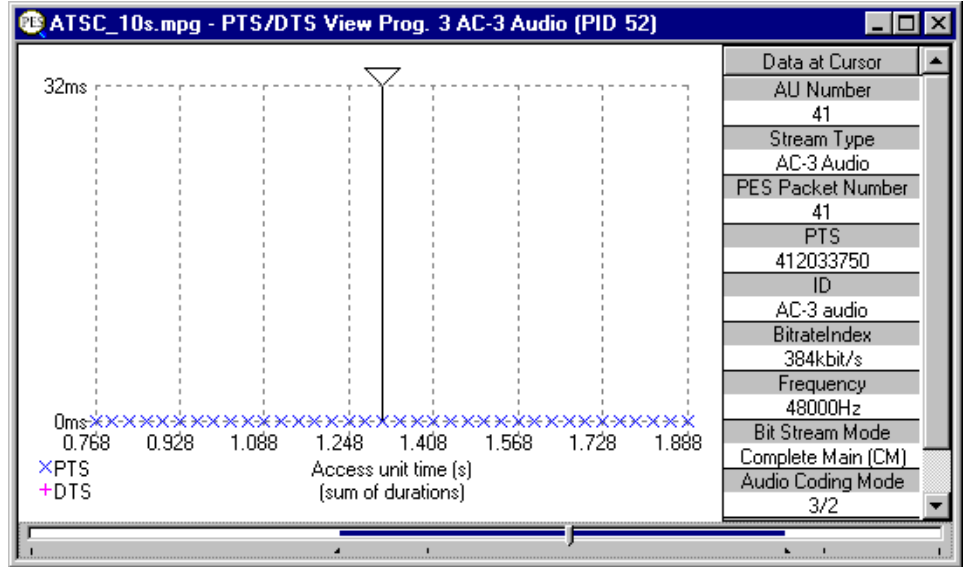

The Data at Cursor panel of the PTS/DTS View shows different information for AC-3 Audio streams. Otherwise the window works in the same way as for Audio streams.

## AAC Audio Streams

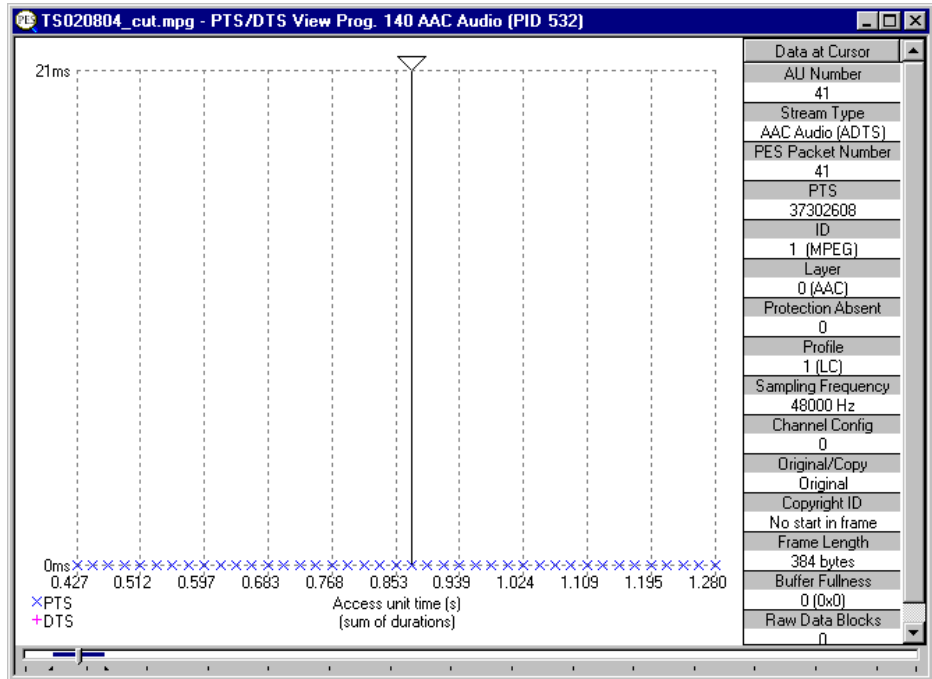

The Data at Cursor panel of the PTS/DTS View shows different information for AAC Audio streams. Otherwise the window works in the same way as for Audio streams.



# **T-STD Buffer Analyzer**



# Table of Contents

<b>Getting Started</b> .....	<b>4-1</b>
Suitable Streams .....	4-1
Table Handling .....	4-2
Starting the Program .....	4-2
Settings .....	4-4
Opening an MPEG File .....	4-8
Opening a BMR File .....	4-10
Window Layout .....	4-10
Initial Processing of MPEG Files .....	4-11
Initial Processing of BMR Files .....	4-12
<b>Menus and Controls</b> .....	<b>4-13</b>
Toolbar .....	4-13
Status Bar .....	4-15
Menu Options .....	4-16
<b>Stream List</b> .....	<b>4-21</b>
Selecting Streams .....	4-23
Processing Streams .....	4-23
<b>Event and Message Logs</b> .....	<b>4-27</b>
Global Event Log .....	4-27
PID Event Log .....	4-28
Trace .....	4-28
<b>Results Graphs</b> .....	<b>4-35</b>
Common Features .....	4-35
Elementary Buffer Graph .....	4-45
Multiplex or Main Buffer Graph .....	4-46
Transport Buffer Graph .....	4-47

## List of Tables

<b>Table 4-1: File menu options</b> .....	<b>4-4</b>
<b>Table 4-2: View menu options</b> .....	<b>4-4</b>
<b>Table 4-3: File menu options</b> .....	<b>4-16</b>
<b>Table 4-4: Edit menu options</b> .....	<b>4-16</b>
<b>Table 4-5: View menu options</b> .....	<b>4-16</b>
<b>Table 4-6: Options menu options</b> .....	<b>4-17</b>
<b>Table 4-7: Process menu options</b> .....	<b>4-17</b>
<b>Table 4-8: Trace menu options</b> .....	<b>4-17</b>
<b>Table 4-9: Window menu options</b> .....	<b>4-18</b>
<b>Table 4-10: Help menu options</b> .....	<b>4-19</b>

# Getting Started

The T\_STD Buffer Analyzer models the behavior of the buffers in the hypothetical Transport Stream System Target Decoder, as specified in ISO/IEC 13818-1. It can process video, audio, and system control streams. The results of the analysis are displayed as graphs of the buffer capacity over time and a log of exceptions and noteworthy events.

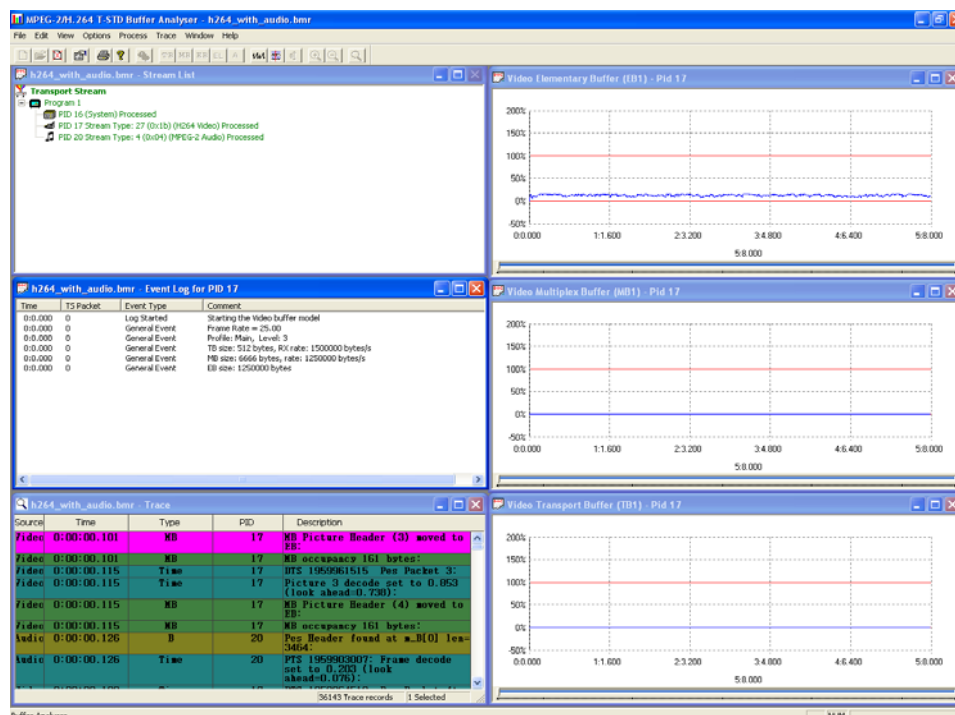

## Suitable Streams

Any valid MPEG file, recorded or synthesized, can be processed by this application. A valid file is one that starts on a transport stream (TS) packet boundary (the first byte of the file must contain the first byte of a TS packet).

The Buffer Analyzer will process video, audio, and system control streams that are compliant with the 1996 standard ISO/IEC 13818 parts 1-3.

It will handle transport streams that contain PCR and/or PTS/DTS discontinuities. The PTS/DTS and PCR in a stream must, however, use the same timebase.

Buffer Analyzer is unable to work on scrambled streams. If it fails to make sense of a stream, use TS Analyzer to determine if the stream is scrambled.

## Table Handling

### Multiple PAT and PMT Versions

Buffer Analyzer forms a list of which elementary streams are present in the transport stream. This is called the Stream List. It creates the Stream List by reading the first occurrence of the Program Association Table (PAT) and Program Map Table (PMT).

If more than one version of the PAT and/or PMT are present TS Cutter may be used to isolate a particular section for analysis.

### MPEG-2, DVB and ATSC Tables

Only PIDs carrying MPEG-2 PSI tables are included in the System model. Any DVB or ATSC tables that are present in the Transport Stream are ignored.

## Starting the Program

The program may be started by selecting the Tektronix Buffer Analyzer option from the Start > Programs menu or by double clicking on the Tektronix Buffer Analyzer Shortcut on the desktop.

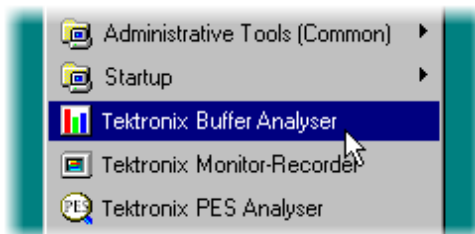

### Initial Appearance

Once the program has started and is ready for use, it will open a Main Window. When the program starts, the main window looks like this:



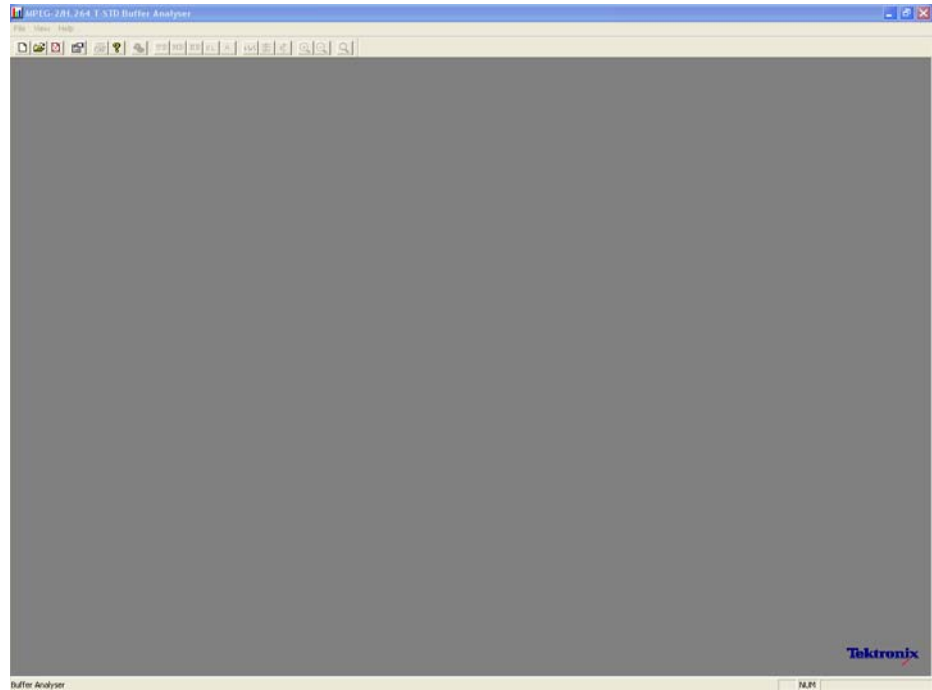

The Toolbar (row of buttons above the dark gray area of the empty window) may be hidden from view, moved to a separate window, or moved to either side or the bottom of the main window.

The Status line at the very bottom of the window may be hidden from view. It displays information about the application and keyboard status.

### **Initial Menu Options**

The application presents different menus and options, depending on whether a file is open for analysis. The menu options available when Buffer Analyzer has just been started, or after a file is closed, are:

**File Menu Options.** Table 4–1 lists the File menu options.

**Table 4–1: File menu options**

Command	Function
New	Opens a stream file for analysis and opens or creates a Buffer Model Results (BMR) file in which to store the results.  The application opens a file selection dialog allowing the user to choose the stream file. It then opens another file selector dialog to specify the BMR file.
Open...	Opens an existing BMR file to review results of a previous analysis. The application opens the file selection dialog allowing the user to choose the required file.
Print Setup...	Opens a dialog for selecting which printer and associated options to use.
1 <filename> 2 <filename> 3 <filename> 4 <filename>	A list of the four most recently used BMR files. If Buffer Analyzer has recently been installed the list may hold less than four files.  Selecting a filename opens that BMR file for review.
Exit	Finishes running the program.

**View Menu Options.** Table 4–2 lists the File menu options.

**Table 4–2: View menu options**

Command	Function
Toolbar	Displays or hides the toolbar.
Status Bar	Displays or hides the status bar.
Settings...	Opens the Settings dialog for specifying Video Buffer Sizes and Video Data Transfer method.

(a check mark next to an option shows that the toolbar is currently visible; no check mark means that it is hidden.)

## Settings

Various configuration parameters, including Packet Interpretation, Pre-Scan Packets, PES Private Interpretation, Video Buffer Sizes, Video Data Transfer method, and Audio Buffer sizes may be modified before and after opening an MPEG file. When a file is open, one or more streams may be analyzed, the settings may be changed, and then other streams may be analyzed with the new settings. If the settings are changed, to reanalyze streams analyzed with previous settings, the MPEG file must be closed and opened again.

It is a good idea to check the settings before opening a file to verify the method with which video streams will be analyzed.

Select Settings... from the View menu to open the Settings dialog.

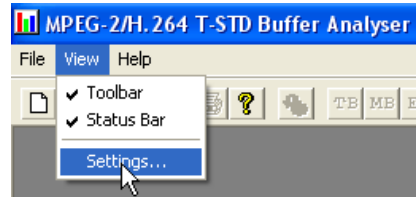

This opens the Settings dialog, which has three tabs: System, Video and Audio.

## System Settings

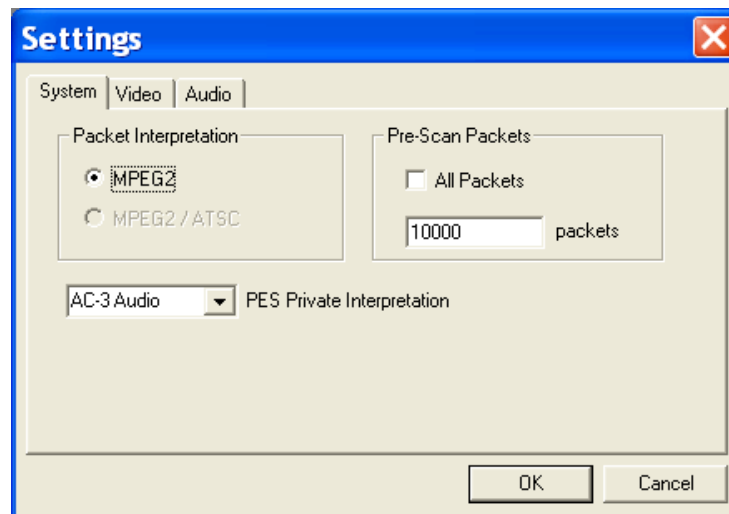

These options can only be set before analyzing a file. They are disabled (grayed out) while a file is open.

The MPEG2 / ATSC option is available on ATSC or ATSC/DVB dual standard MPEG Test System products. It is disabled (grayed out) on single standard DVB systems.

**Packet Interpretation.** Specifies which standards will be used for interpreting the packets in the Transport Stream when a file is opened for analysis. The options are:

**MPEG2**                      Interprets the packets according to the standards for DVB streams.

**MPEG2 / ATSC**      Interprets the packets according to the ATSC standards. This option is required to allow AC-3 audio stream content to be analyzed.

**Pre-Scan Packets.** During the initial processing of an MPEG file, a number of packets are prescanned for information that will result in a more accurate analysis of the initial parts of the transport stream. The greater the number of prescanned packets, the greater the chance of locating all of the information required for accurate analysis. The drawback is increased processing time. By default, 10000 packets are prescanned, which should be sufficient for most streams, excluding High Definition Video.

**All Packets**              Select this check box to cause all packets to be prescanned. If this check box is selected, the packets field will be disabled (grayed out).

**Packets**                  If the All Packets check box is not selected, enter the number of packets to be prescanned in this field.

**PES Private Interpretation.** This setting specifies the model type to use for streams signaled as PES Private (stream\_type = 6).

The selections available include the following: AC-3 Audio, AAC Audio, MPEG-2 Audio and Video and System. The default setting is AC-3 Audio.

## Video Settings

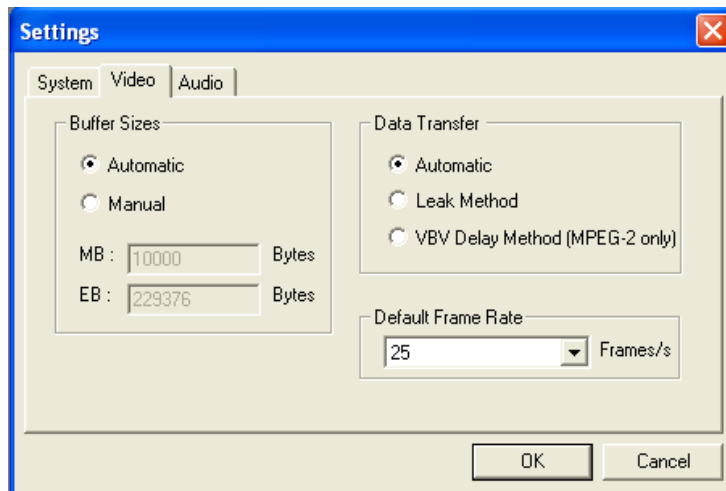

**Buffer Sizes.** Specifies the sizes that will be used for the Main and Elementary Buffers, when interpreting the stream. The options are:

- Automatic** Automatically detect the buffer sizes from the Sequence Headers and Extensions in the elementary stream being processed. This is the default option when the application is started.
- Manual** Enables the size of the Main or Multiplex buffer (MB) and Elementary Buffer (EB) to be specified manually. The MB and EB fields are available for editing when this option is enabled.

**Data Transfer.** By default Buffer Analyzer inspects the stream to determine which transfer method to use. This can be overridden if required. The options are:

- Automatic** Examines the stream to determine the transfer method. This is the default option when the application is started.
- Leak Method** Initiates modeling of the stream using the Leak Method. H.264 streams support only this method but the option can be kept as Automatic.
- VBV Delay Method** Initiates modeling of the stream using the Video Buffer Verifier (VBV) Delay Method. This option is specific to MPEG-2.

**Default Frame Rate.** The frame rate is one of the parameters that is searched for during the prescan phase of analysis. However if it is not found, then the default value selected from the drop-down list in the Default Frame Rate field is used.

## Audio Settings

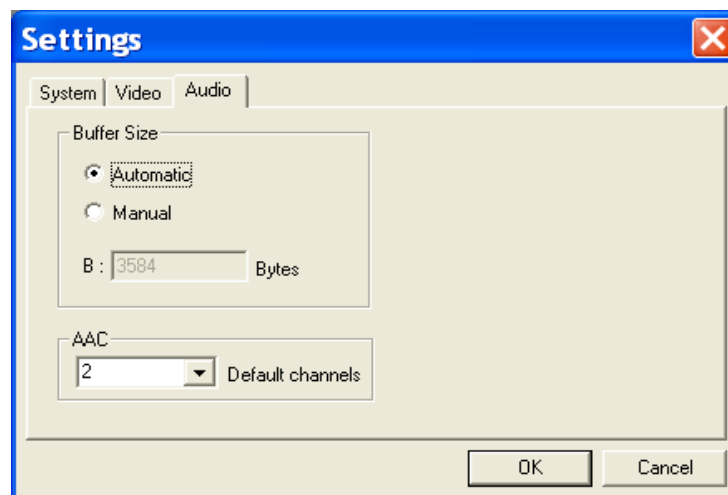

**Buffer Size.** Specifies the size that will be used for the audio buffer when interpreting the stream. The options are as follows:

<b>Automatic</b>	Automatically detect the buffer sizes from the Sequence Headers and Extensions in the elementary stream being processed. This is the default option when the application is started.
<b>Manual</b>	Enables the size of the buffer (B) to be specified manually. The B field is available for editing when this option is enabled.

**AAC.** Select the number of AAC channels required from the drop-down list.

Within the ADTS (Audio Data Transfer Stream) fixed header, the channel configuration field is used to indicate the number of channels required by AAC. If the number in this field is zero, then the value in the AAC Default channels field is used.

Note that the associated ADIF (Audio Data Interchange Format) is unsupported.

Refer to Information technology –  
Generic coding of moving pictures and associated information,  
Part 7: Advanced Audio Coding (AAC) ISO/IEC 13818-7:1997

---

**NOTE.** Remember that if the settings are modified, the new settings are used for all video streams that are subsequently processed. The settings are reset to the default option when the application is started.

---

## Opening an MPEG File

Any file holding a recorded or synthesized sample of a Transport Stream that carries video, audio, and/or system control streams can be analyzed. These files are referred to as MPEG files to distinguish them from Buffer Model Results (BMR) files. The results of analysis are written to a BMR file.

### Opening a File from the Menus and Toolbar

To open a file for analysis, select the New option from the File menu. Alternatively, use the Ctrl+N keyboard shortcut.

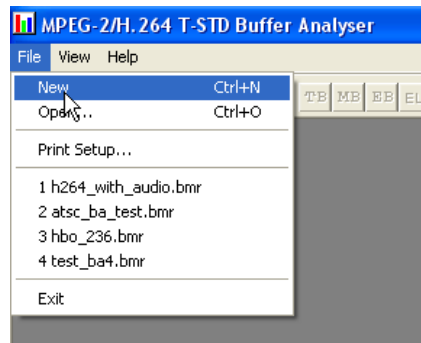

---

**NOTE.** The list of previously used files shows BMR not MPEG files, as can be seen by their .bmr extension.

---

There is a shortcut button, for the New command, on the Toolbar:



In response to the New command, the Buffer Analyzer opens a file selection dialog to choose an MPEG file for processing. When the MPEG file has been chosen, the MPEG file selector closes and another file selection dialog opens. This is for choosing a Buffer Model Results File (BMR), which holds the results of any analysis performed on the MPEG file.

Buffer Analyzer suggests an output file with the same name as the MPEG file but a file extension of .bmr to hold the Buffer Model Results. Select OK to accept the suggested filename. Otherwise select a different file or type in a different name and then select OK.

---

**NOTE.** Choosing an existing BMR file will erase all results that had previously been saved in that file.

---

## Opening a BMR File

An existing Buffer Model Results (BMR) file can be opened to review the results saved in it from previous Buffer Model Analysis.

### Opening a File from the Menus and Toolbar

To open a BMR file select the Open... option from the File menu. Alternatively use the Ctrl+O keyboard shortcut.

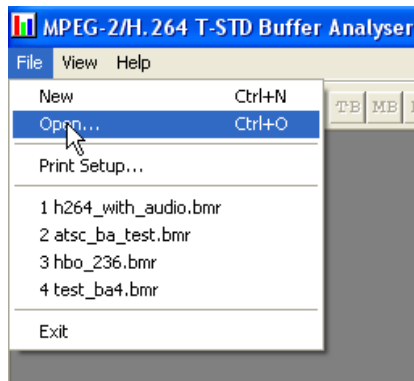

If the required file is in the list of recently analyzed BMR files, it can be opened from the list to save using the open file dialog.

There is a shortcut button available on the Toolbar for opening a file, which has the standard file open symbol:



## Window Layout

The Stream List window is opened as soon as either an MPEG or BMR file is opened. The application inspects the file to find what program streams are present according to the Packet Interpretation setting. For example:



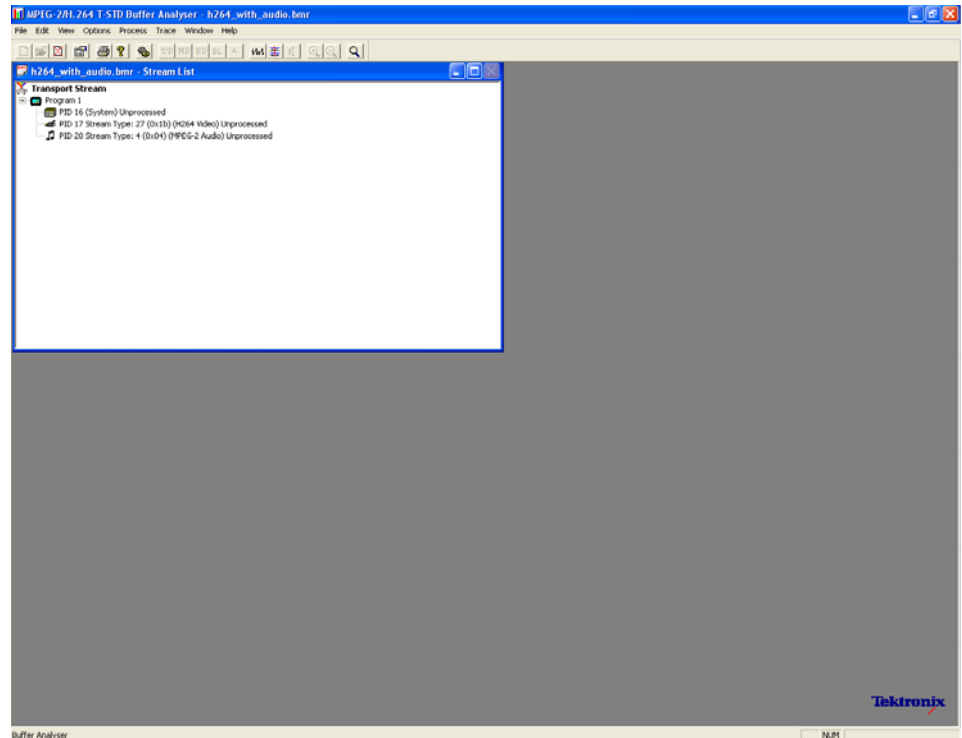

## Initial Processing of MPEG Files

If an MPEG file is opened, the program performs initial analysis to form the Stream List and calculate the mean transport rate. All streams in the list are marked as Unprocessed, because no analysis has been performed on them in this session.

To build the Stream List the MPEG file is scanned for the PAT and PMT table contents. It is assumed that the contents are constant, which is the general case. If the program changes in a drastic way, such as streams disappearing between PMTs, the model will give meaningless results.

Only the first occurrence of complete PAT and PMT are read when forming the Stream List. Use TS Cutter to isolate a section when multiple versions of the tables occur.

A number of packets in the file are scanned for the Sequence Header and Extension start codes (containing profile and level) (see Settings, page 4–4). If they are not found the Main Profile and Level setting are assumed together with the maximum VBV buffer size.

## **Initial Processing of BMR Files**

If a BMR file is opened, the State column indicates which streams had been processed. The file only holds results for those streams marked as Processed. To obtain results for unprocessed streams, the original MPEG file will have to be opened again and analyzed.

# Menus and Controls

When a file is open, the program presents a different set of menus and options. They change as soon as the Stream List window appears. For example, the Open file commands are replaced by Close file commands.

## Toolbar

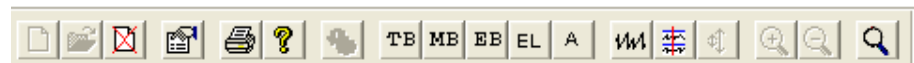



The Toolbar provides a set of convenient shortcuts for the more frequently used menu options. The available commands are:







	Opens dialogs to select an MPEG file for analysis and a BMR file for saving the results. This button is disabled (grayed out) when a file is open.
	Opens a dialog to select a BMR file to review the results of a previous analysis session. This button is disabled (grayed out) when a file is open.
	Closes the current file. This button becomes available the moment a file is opened. If the wrong file is being opened, or the wrong options are selected, clicking on the button will abandon the analysis and close the file.
	Opens the Settings dialog.
	Prints the contents of the current window.
	Opens a dialog which displays the program version number.
	Analyzes the stream(s) from the PID(s) which are currently selected in the Stream List. This button is only enabled when one or more PIDs which are marked as unprocessed are selected.

The next group of five buttons open Results Views for the selected streams.

	Opens a graph of the Transport Buffer for the selected stream. This button is only enabled when the PID of a Processed stream is selected in the Stream List window.
	Opens a graph of the Multiplexing Buffer of a video stream; Main Buffer of an audio stream or of a system information stream. The button is only enabled when the PID of a Processed stream is selected in the Stream List.

	Opens a graph of the Elementary Stream Buffer for the selected video stream. This option is only available when a PID carrying a Processed Video stream is selected in the Stream List.
	Opens the Event Log for the selected stream. The button is only enabled when the PID of a Processed stream is selected in the Stream List window.
	Opens all of the relevant graphs and the event log for the selected stream. This option is only available when a PID carrying a Processed Video stream is selected in the Stream List.

The remaining buttons control display options for Graphs of buffer analysis results.

	Toggles the graph displays between having all points drawn and sampling the points for drawing.
	Synchronize Graphs toggles the graphs between using the same position and zoom settings or operating independently.
	Auto Scale toggles the selected graph between fixed and auto scaling of the y axis.
	Zoom In increases the magnification along the x-axis (time scale) of the currently selected graph. All graphs are affected if Synchronize Graphs is enabled.
	Zoom Out reduces the magnification along the x-axis (time scale) of the currently selected graph. All graphs are affected if Synchronize Graphs is enabled.
	Trace analyzes the message logs. You can view the message log that is produced by the Buffer Analyzer.

The Toolbar can be dragged off the edge of the main window into a floating pallet. To do this, place the mouse pointer on the background inside the Toolbar, (not on one of the buttons), hold the left button down, and drag into the main window area. The result is a self-contained window that looks like this:



To replace the Toolbar on the window border drag it over the border, until the outline changes shape, and release it. It can be placed on the top, bottom, left or right hand edges.

## Status Bar



The Status Bar may be hidden from view, but if is visible, it is always at the bottom of the main window. It displays the following information about the program and keyboard states:

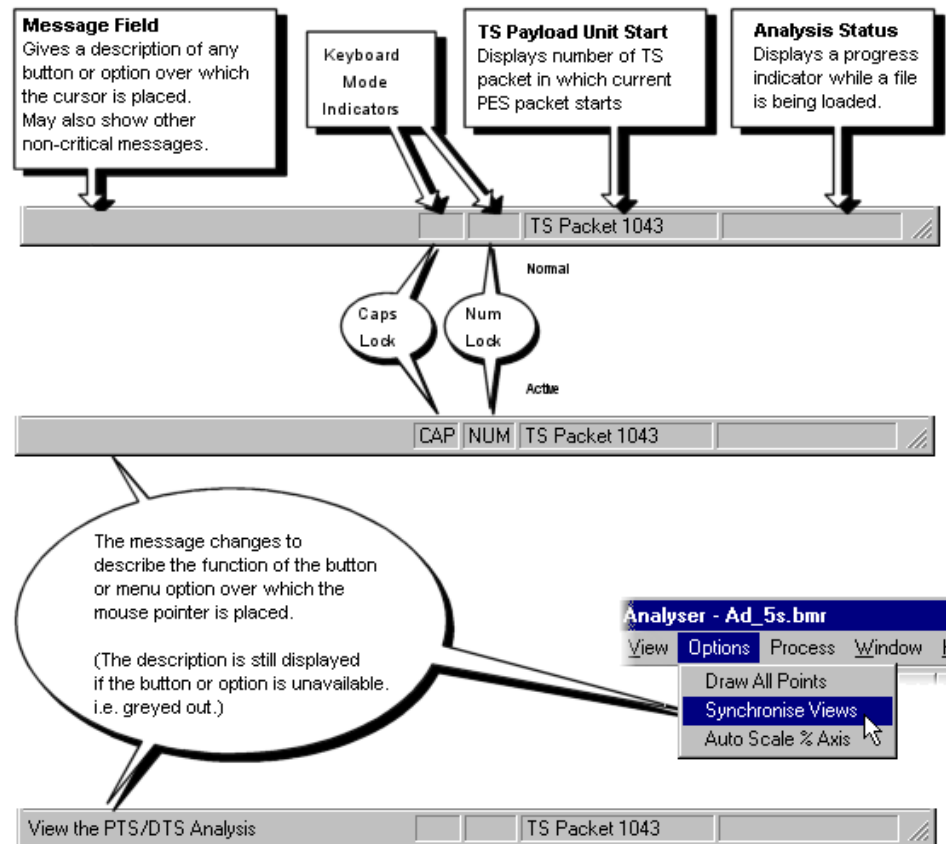

## Menu Options

Table 4–3 to Table 4–10 list the available menu options.

**Table 4–3: File menu options**

Command	Function	
Close	Closes the current file. This option is available as soon as analysis starts. If the wrong file is being opened, or the wrong options are selected, selecting this option will abandon the analysis and close the file.	
Print	Prints contents of the current window.	
Print Preview	Prints contents of the current window.	
Print Setup	Selects printer and configuration.	
Trace Print Options	Font	Selects the font to be used for printing text.
	Colors	Not available with Buffer Analyzer.
Exit	Closes any file that is open and terminates the program.	

**Table 4–4: Edit menu options**

Command	Function
Cut	Moves the currently selected records from the main window to the clipboard.
Copy	Copies the contents of the currently selected records to the clipboard. They are not removed from the main window.
Delete	Deletes the selected records from the main window.
Delete Except	Deletes all records except those selected from the main window.
Delete All	Deletes all records.
Select All	Selects all records.

**Table 4–5: View menu options**

Command	Function
Toolbar	Shows or hides the Toolbar.
Status Bar	Shows or hides the Status Bar.
Settings...	Opens the Settings dialog.
Global Event Log	Shows or hides the Global Event Log window.
Transport Buffer	Opens a graph of the Transport Buffer for the selected PID.

**Table 4-5: View menu options (Cont.)**

Command	Function
Main Buffer	Opens a graph for the selected PID in the Stream List. The graph shows results for the Main Buffer of audio and system streams or the Multiplex Buffer for video streams.
Elementary Buffer	Opens a graph of the Elementary Buffer for the selected PID.
PID Event Log	Displays the Event Log for the selected PID.
All Buffers	Opens all graphs and the log for the selected PID.
Trace	Generates a detailed trace log.

**Table 4-6: Options menu options**

Command	Function
Draw All Points	Toggles between drawing all points on the graphs, drawing every nth point. 'n' is calculated from the total number of data points and the screen space for the graph.
Synchronize Views	Toggles the graphs between using the same position and zoom settings and operating independently.
Auto Scale % Axis	Toggles the selected graph between fixed and auto scaling of the y axis.

**Table 4-7: Process menu options**

Command	Function
Process Streams	Applies the stream(s) from the PID(s) selected in the Stream List to the System Target Decoder Buffer Model.  This option is only enabled when one or more unprocessed PIDs are selected in the Stream List.

**Table 4-8: Trace menu options**

Command	Function
View	
Column	Opens the column definition dialog box for selecting the columns of information that has to be displayed.
Font	Selects the font that is used for displaying the text of detail message log records.

**Table 4-8: Trace menu options (Cont.)**

Command	Function
Colors...	Selects background and text colors that are used to display each type of message.
Newest End	Displays the newest record.
Show	
Markers	Shows markers permanently while using Trace with the Buffer Analyzer.
General Text	Shows or hides general messages. For example, messages indicating start of processing for a particular PID.
Fixed	Shows or hides information such as transport rates and buffer sizes.
PCR Timestamp	Shows or hides messages about PCRs and associated instantaneous transport rates.
System...	Selects which types of system messages to show.
Audio...	Selects which types of audio messages to show.
Video...	Selects which types of video messages to show.

**Table 4-9: Window menu options**

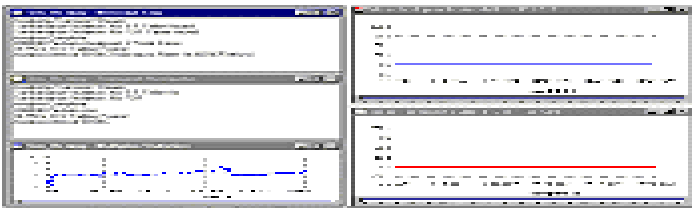
Command	Function
Cascade	Cascades the windows. 
Tile	Tiles the windows. 
Arrange Icons	Arranges any minimized windows along the bottom of the main window. Aligns icons of any minimized windows at the bottom of the program's main window.
1 <window file>	Lists all of the available windows. A check mark indicates the active window. Select an option to bring that window to the top.



**Table 4-10: Help menu options**

<b>Command</b>	<b>Function</b>
About Buffer Analyzer...	Opens a dialog that displays the program version number.



# Stream List

The Stream List is displayed in the form of a tree view. The tree view is grouped and sorted by the program numbers with the label for the PIDs, stream types, and the states displayed. The Stream List displays all the elementary streams in the file. An unprocessed state is indicated by the black label and the processed state is indicated by the green label.

The '+' symbol displayed to the left of some icons indicates that the item includes lower-level stream components that are not displayed. The symbol changes to '-' when the lower level components are displayed. To expand the hierarchy click on the '+' symbol. Similarly, to collapse the hierarchy click on the '-' of the selected upper-level icon.

The System, Audio, and Video PIDs of a specific program number are displayed as leaf nodes of the same level.

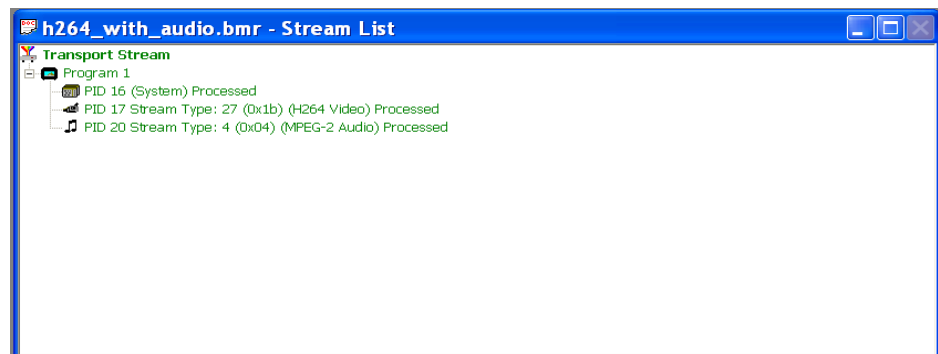

Stream Type includes Video, Audio, AC-3 Audio, AAC Audio, System, or Private. Private streams cannot be processed, but may show more information about the type, for example ISO/IEC 13818 Auxiliary. The Packet Interpretation from the System tab of the Settings dialog box sets the standard that is used for identifying these types.

The preceding example is from a DVB compliant transport stream.

An ATSC stream might look like this:

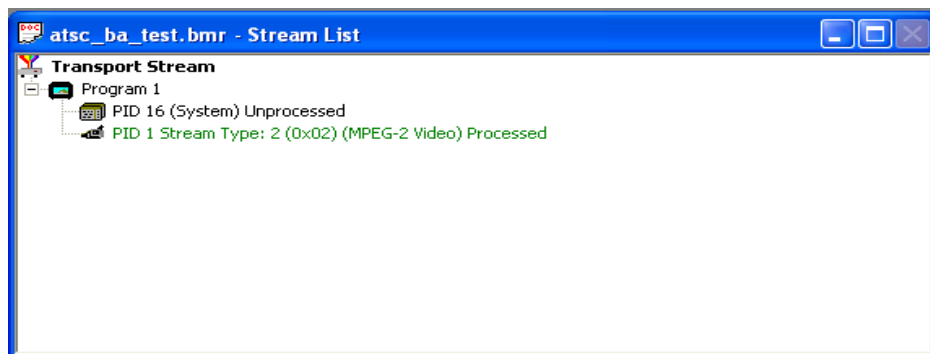

This tree view lists out processed (analyzed in the buffer model) and unprocessed streams. A stream may be processed only once when the file is open. To process a stream again, the file must be closed and then opened again.

When an MPEG file is first opened, the program streams are all marked as Unprocessed. Unprocessed state indicates that no buffer analysis has been so far performed in this session.

If a BMR file is opened, the streams state will be displayed as processed or unprocessed. The file only holds results for those streams marked as Processed. To obtain results for unprocessed streams the original MPEG file will have to be reopened and analyzed.

## Selecting Streams

To analyze or open the results views for a stream, or streams, they must first be selected in the Stream List. To select a stream, click on the PID number.

For example, click on PID 1 Stream Type text to select the Video stream carried in PID 1.



By using the Shift and Control key, you can make multiple selections for all the tree nodes.

You can select the highest level node to process all the descendent nodes. For example, selecting the highest level transport stream node will process all the PIDs or selecting a specific program level node will process all the PIDs of that program.

To select a contiguous range of streams: click on the first streams PID, then hold the Shift or **▲** key down and click on the last stream's PID number. If the required streams are not adjacent, hold the Ctrl key down and click on the PID number for each stream.

All streams can be deselected by clicking the mouse pointer outside the tree view data. To deselect a particular stream while leaving the others selected, hold the Ctrl key down and click the stream's PID number.

## Processing Streams

Having selected one or more streams from the Stream List they can be analyzed in the buffer model.

To start analysis, select the Process Streams option from the Process menu.

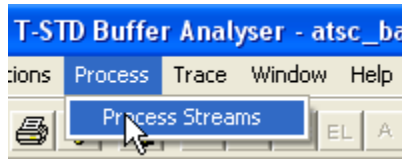

Alternatively, click on the Process button in the toolbar.



You can also process the highlighted streams by selecting Process Streams from the shortcut menu.

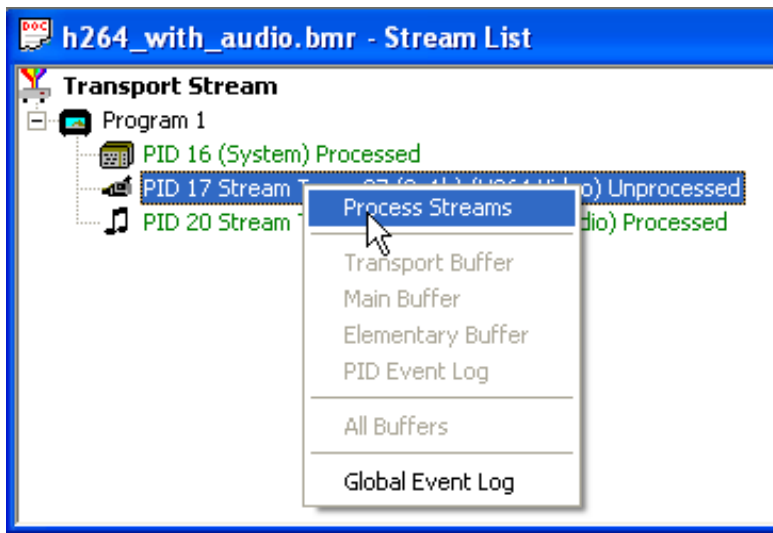

When H.264 streams with SEI (HRD) parameters is processed a dialog box is displayed prompting you to either continue or abort the processing of streams. If you continue, STD leak method will be used for analysis. If you abort the process, the state of that stream will be displayed as aborted.

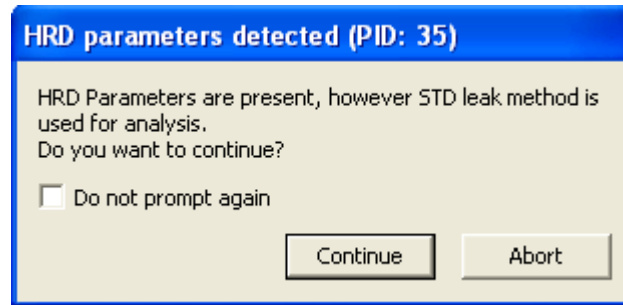

---

**NOTE.** For HRD model analysis use Tektronix ES Stream Analyzer (MTS4EA).

---

### Supported Profiles & Levels

Buffer Analyzer supports 6 Profiles for MPEG-2 video: Simple, Main, SNR, Spatial, High, and High4.2.2.

Buffer Analyzer supports 7 Profiles for H.264: Baseline, Main, Extended, High, High10, High4.2.2, and High4.4.4.

It supports 4 Levels: High, High - 1440, Main, and Low.

Details of valid combinations of profile and level are given in standards document ISO/IEC 13818 part 2 section 8.5.

### Start-Up

The hypothetical T-STD specified in ISO/IEC 13818 part 1 section 2.4.2 assumes a processing steady state. To handle the start-up processing before reaching the steady state Buffer Analyzer performs as follows:

- The fraction of the first video frame leading up to the first picture start code is not passed through the Buffer Analyzer. This is because it is not possible to determine whether the Leak or VBV Delay method is being used. During this period, the PES header, Sequence Header, and Extension information are extracted. This information is used to determine the initial DTS, size of the MB and EB buffers.
- The Decoding Time Stamp (DTS) for the first frame is assumed to be correct. It is used as a base for the timing of all subsequent frames. MB underflow errors are suppressed during the first frame.

If the DTS of the first frame is not correct, use TS Cutter to remove the suspect frame(s) from the file.

### Approximations

The application uses the following approximations to model the behavior of the hypothetical T-STD:

- Data is processed one packet (188 bytes) at a time. An underflow/overflow condition that occurs and clears within the period of one packet will be missed.
- Processing one packet at a time causes the buffers to be emptied in block fashion, thus giving a stepped graphical output.
- Slight quantization effects occur because the model is processed at discrete time intervals, corresponding to a single packet length. This may affect the VBV Delay calculations. The timing intervals for transferring frames from MB to EB are dynamically adjusted to compensate.



# Event and Message Logs

The T-STD Buffer Analyzer allows you to access the Global Event log and the PID Event log. You can use the Trace to create a log containing a more detailed analysis of the entire process.

The views can be synchronized by selecting the Synchronize Views option from the Options menu. While Synchronize Views is enabled a change to any view is immediately applied to all the other views.

## Global Event Log

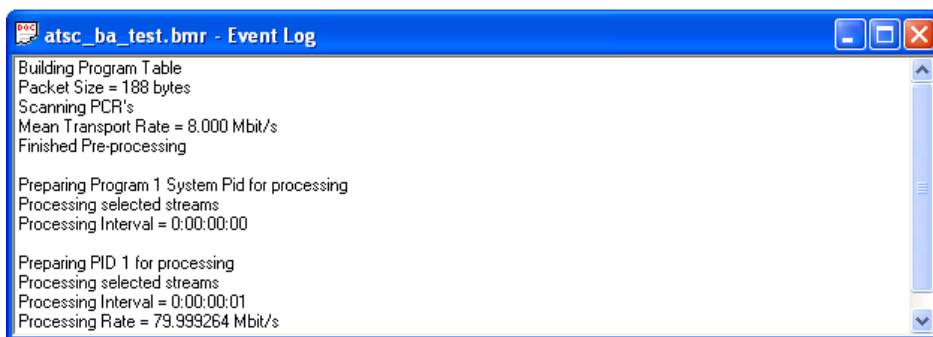

The Global Event Log displays: reports from the initial analysis, PID independent information (Transport Stream errors) and high level details for each stream processed.

For details of events detected during the processing of a stream, open the PID Event Log for that stream.

## PID Event Log

Time	TS Packet	Event Type	Comment
0:0.000	0	Log Started	Starting the Systems buffer model
0:0.000	0	General Event	TB size: 512 bytes, RX rate: 125000 bytes/s
0:0.000	0	General Event	B size: 1536 bytes, R rate 16000.000 bytes/s (127999.999 b
0:0.001	3	TB Overflow Start	Start of TB overflow
0:0.007	39	Fatal Error	TB is full, Data being discarded
0:0.007	39	TB Overflow End	End of TB overflow

An Event Log window may be opened for each PID that has been or is currently being processed. Results are written to the log as they are produced. All time and packet numbers are given relative to the start of the file.

### Event Selection

Selecting an event row from the Event Log will place a cursor at that time in each of the Buffer Results graphs. To select an event, click on the row of the desired event.

Time	TS Packet	Event Type	Comment
0:12.080	64254	B/MB Overflow Start	Start of MB overflow
0:12.110	64413	General Event	VBV_DELAY period exceeds available time before dec
0:12.117	64450	B/MB Overflow End	End of MB overflow
0:12.118	64457	General Event	VBV_DELAY period exceeds available time before dec
0:15.273	81238	B/MB Overflow Start	Start of MB overflow
0:15.352	81661	General Event	VBV_DELAY period exceeds available time before dec
0:15.403	81931	B/MB Overflow End	End of MB overflow
0:15.697	83496	B/MB Overflow Start	Start of MB overflow
0:15.797	84028	General Event	VBV_DELAY period exceeds available time before dec
0:15.802	84052	General Event	VBV_DELAY period exceeds available time before dec
0:15.872	84423	B/MB Overflow End	End of MB overflow
0:16.095	85614	B/MB Overflow Start	Start of MB overflow

To deselect an event, click the mouse pointer outside the data column.

## Trace

The Trace is used for analyzing the message logs produced by the Buffer Analyzer. The message logs may be useful for in-depth analysis of the internal processing, particularly for the video stream type. Trace has filtering capabilities that allow you to focus on message types of particular interest.

Trace record is displayed only for processed streams.

Source	Time	Type	PID	Description
Audio	0:03:57.467	B	20	B occupancy 2072 bytes. Removing frame of size 576 bytes:
Audio	0:03:57.467	Time	20	Frame rate= 41.67 intDTS= 21374226:
Audio	0:03:57.491	B	20	Pes Header found at m_B[39898] len= 3464:
Audio	0:03:57.491	Time	20	PTS 1981261087: Frame decode set to 237.515 (look ahead=0.024):
Audio	0:03:57.491	B	20	B occupancy 2048 bytes. Removing frame of size 576 bytes:
Audio	0:03:57.491	Time	20	Frame rate= 41.67 intDTS= 21376386:
Audio	0:03:57.515	B	20	B occupancy 2010 bytes. Removing frame of size 576 bytes:
Audio	0:03:57.515	Time	20	Frame rate= 41.67 intDTS= 21378546:
Audio	0:03:57.539	B	20	B occupancy 2132 bytes. Removing frame of size 576 bytes:
Audio	0:03:57.539	Time	20	Frame rate= 41.67 intDTS= 21380706:
Audio	0:03:57.563	B	20	B occupancy 2146 bytes. Removing frame of size 576 bytes:
Audio	0:03:57.563	Time	20	Frame rate= 41.67 intDTS= 21382866:
Audio	0:03:57.587	B	20	B occupancy 2058 bytes. Removing frame of size 576 bytes:
Audio	0:03:57.587	Time	20	Frame rate= 41.67 intDTS= 21385026:

7983 Trace records 0 Selected

## User Interface

To start Trace, select the Trace option from the View menu.

Alternatively, click on the Trace button in the toolbar.

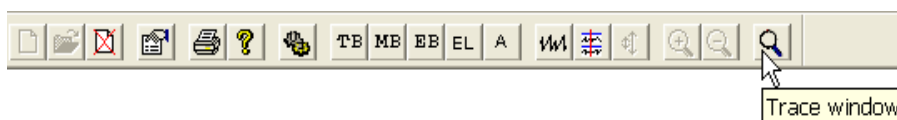

Trace displays the detailed message log in the main window. It has a Status bar at the bottom of the window and a scroll bar on the right side.

The Status bar may be hidden from view, but when it is visible it is always at the bottom of the main window.

## Detailed Message Records

These are displayed in the trace window as table. Each record is represented by a single row of the table. The window displays buffer sizes, transfer rates, profiles, levels, and frame rates that are used for the analysis. They also display the data movements between buffers and their occupancies with respect to time and packet numbers.

The example shows a log in which a PID (PID 17) carrying video was analyzed and then another PID (PID 20) carrying audio was analyzed.

The types of messages that are displayed in the trace window is selected from the Show menu.

To move forward and backward through the log use the scroll bar on the right of the window, the Page Up, Page Down, Cursor Up Arrow, and Cursor Down Arrow Keys.

**NOTE.** If more than one PID is processed concurrently by Buffer Analyzer, the records will be interleaved in the Trace display. Unless this interleaving is required, processing one PID at a time will make it easier to follow the messages for each stream.

### Selecting Records

Records may be selected for printing, copying, deleting, and other Edit menu operations. To do this, they must first be selected.

A single record can be selected by clicking on it. To select a contiguous range of streams, click the first record to be selected and then hold the Shift down and click the last required record. Alternatively, click the first record, hold the left mouse button down and drag the pointer to the last record.

Selected records are repainted in the highlight color scheme. By default, this is black text on a magenta background. For example:

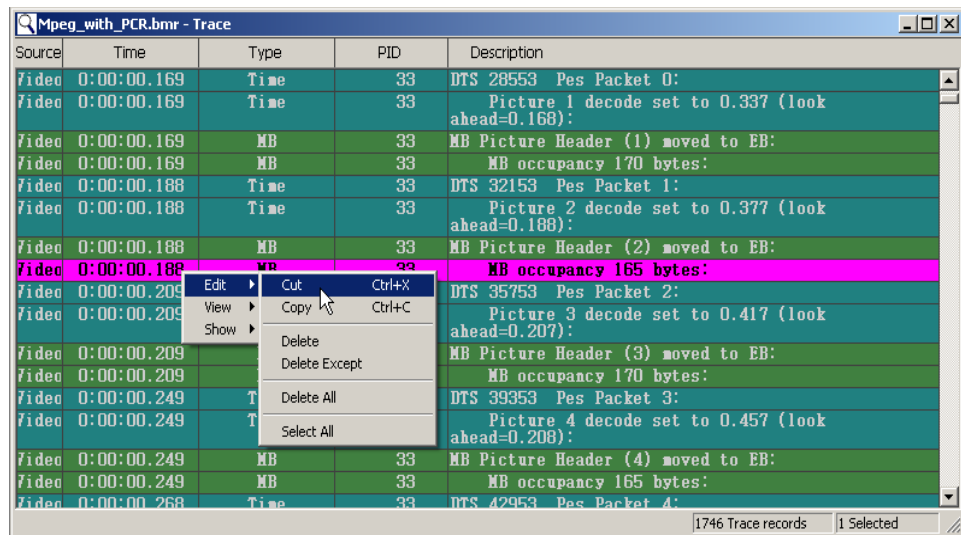

The selected records can be edited and viewed by using the shortcut menu option. You can edit (cut, copy, delete) records, define the Trace (column, font, colors), and select messages (System, Audio, Video) to be displayed in the Trace. You can also show/hide general text, fixed, and time stamp features.

**Column Options** To set the columns of information that are displayed in the Trace table, select the Column option from the View menu.

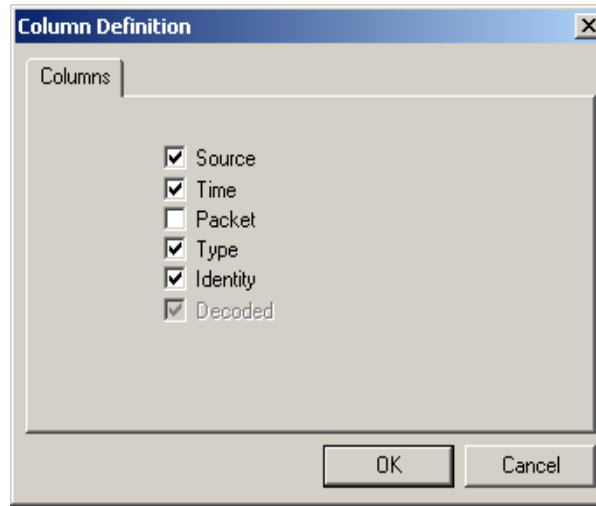

A column is shown for each option that is enabled and is indicated by a check mark. Clicking on an option toggles it between being shown or hidden.

**Fonts** The font of the messages displayed in the Trace table can be changed using the Font dialog box.

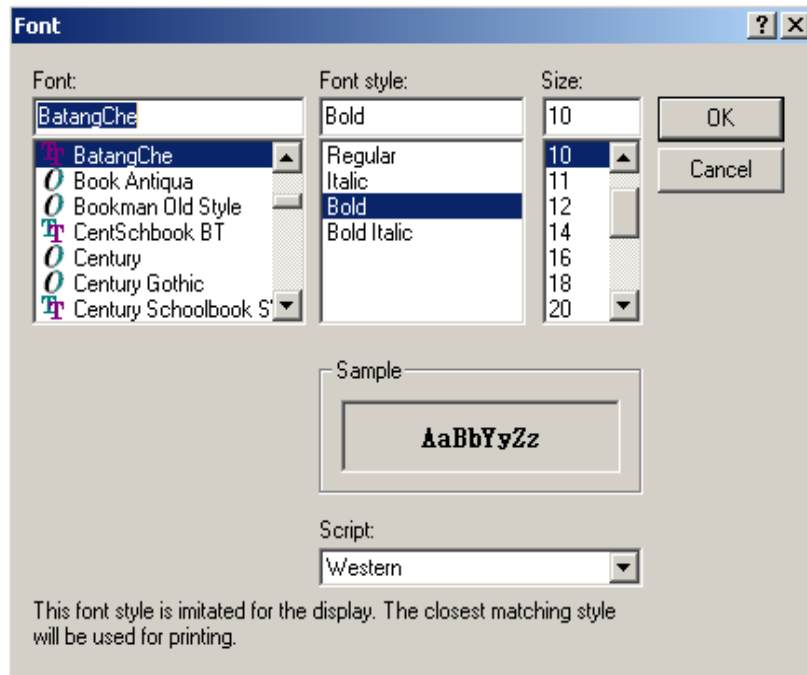

You can select the font, font style, size, and script from this dialog box. A sample of the selected font is displayed in the Sample display box. Click OK to see the selected font in the Trace table.

**Color Schemes** The color scheme for each message type and for highlighting selections can be changed using the Select Colors dialog box.

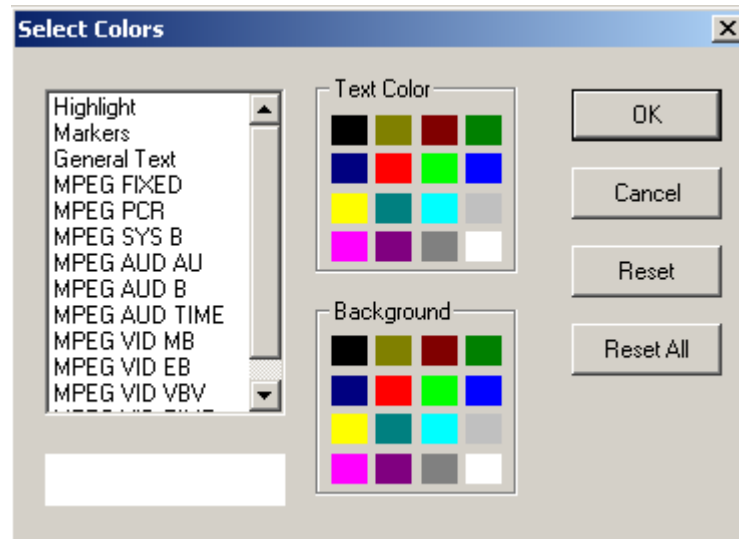

To modify the color schemes, select the Colors option from the View Menu. This opens the Select Colors dialog box.

Select the message type to be changed from the list box on the left. The current color scheme will be displayed in the Sample underneath the list box. Click on the swatch (colored square) in the Text Color and Background panels for the required text and background colors.

Repeat the procedure for each message type that is to be changed and click OK.

The Reset button restores the selected message type to the default color scheme. The Reset All button restores all the color schemes to their defaults.





# Results Graphs

The results of the analysis are plotted on a separate graph for each buffer. When a graph is opened for a stream that is still being processed, each result is plotted as soon as it is produced from the model.

All of the graphs have a similar format and controls.

## Common Features

**The Axes** All of the graphs plot time from the start of file on the x-axis and current space used in the buffer on the y-axis.

**Zoom** When the results graph is first opened, the entire graph is shown. Even a small file may display data points packed too closely to see the features clearly. For example, here is just under 20 seconds of a video stream that generated a lot of events:

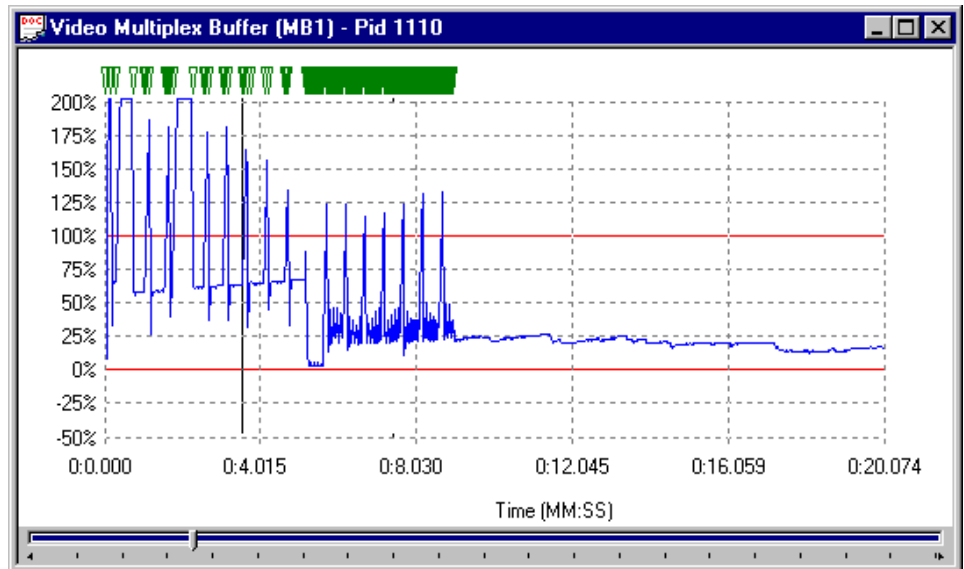

Even this small sample holds some solid bands of blue lines and green event markers, from which only general trends can be determined. To change the time scale (x-axis) to resolve finer detail, click on the Zoom In button on the Toolbar:



Zoom in as many times as required to achieve the desired magnification. The magnification is doubled each time the button is clicked.

In this example, clicking on the Zoom In button three times gave a much clearer view:

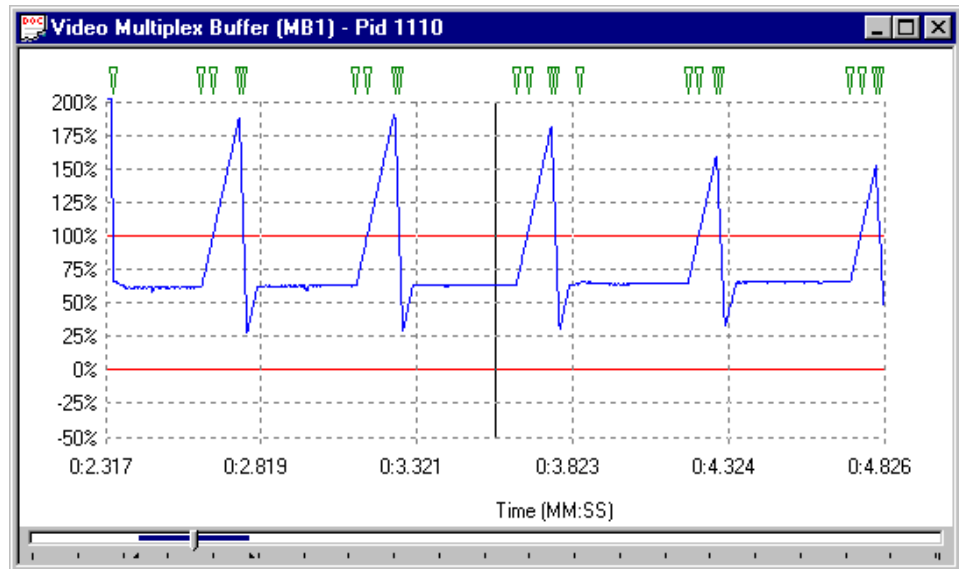

To Zoom back out, click on the Zoom Out button as many times as required:



Each time the Zoom Out button is clicked, the magnification is halved, until the full graph is again displayed.

## Scrolling the View

The slider at the bottom of the window indicates where the displayed area is in relation to the rest of the file. It can be used to scroll the display through the graph in a similar way to a window scroll bar.

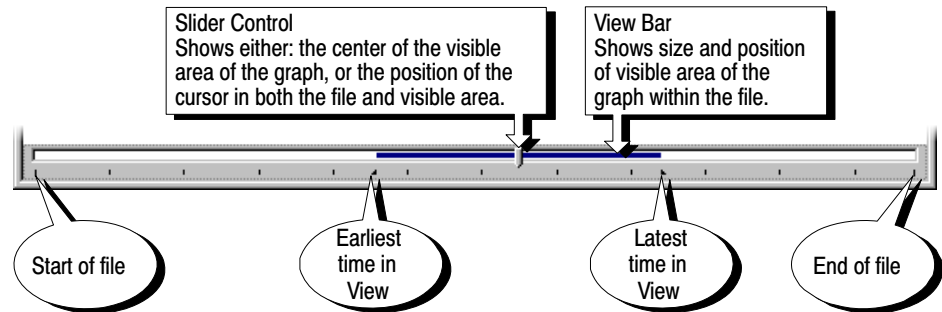

To scroll the stream through the view:

- Drag the Slider Control left or right with the mouse.
- Click the mouse pointer in the slider bar (either the clear sections or the view bar) to the side of the Slider Control.

When a time or event is selected on the graph, the Slider Control is automatically repositioned within the View Bar. The placement of the Slider Control reflects the position of the selected packet in the field of view.

## Event Markers

A graph may show one or more green triangular markers along the top. Each marker indicates the time a particular event, listed in the PID Event Log, occurred.

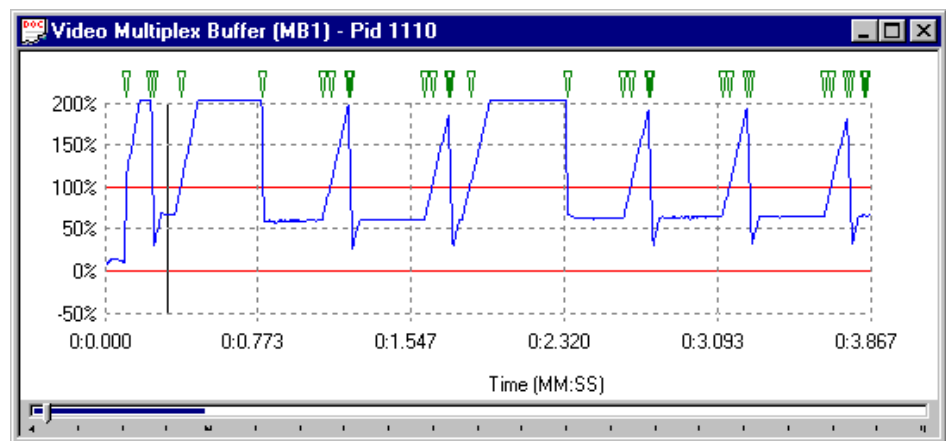

Only events that relate to the points plotted on the graph are displayed in that graph. Hence an event relating to a Video Multiplex Buffer will only be marked

on the Video Multiplex graph and not on the Elementary or Transport Buffer graphs.

Double-clicking on a marker will display a pop-up window. This shows the time and a brief description of the event that is marked.

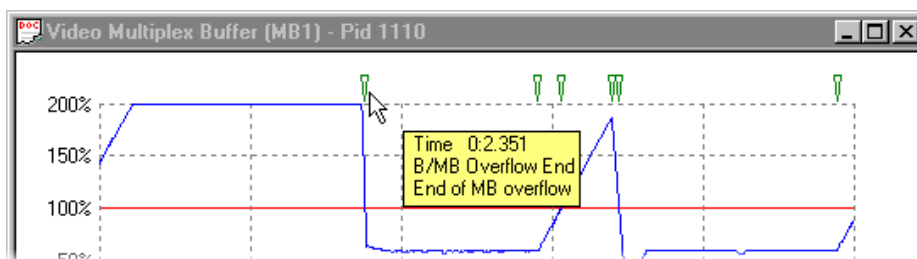

For example: selecting an event relating to the Elementary Buffer from the Event Log of a video stream will place a cursor at the time of the event in the buffer results graphs. Looking at the graphs, a marker of the event has been placed on the Elementary Buffer graph, but not the Multiplex Buffer graph.

Test2.bmr - Event Log for PID 610

Time	TS Packet	Event Type	Comment
0:29.569	157284	General Event	VBV_DELAY period exceeds availat
0:29.609	157497	General Event	VBV_DELAY period exceeds availat
0:29.640	157662	EB Underflow Start	Start of EB underflow
0:29.649	157709	General Event	VBV_DELAY period exceeds availat
0:29.655	157739	EB Underflow End	End of EB underflow
0:29.689	157920	General Event	VBV_DELAY period exceeds availat

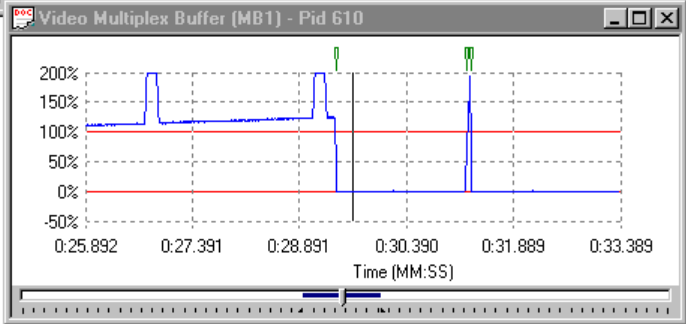
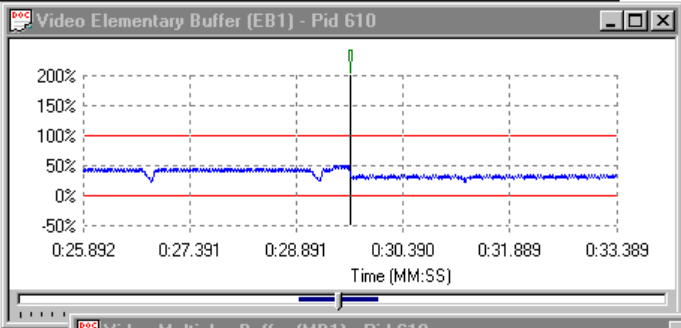

**Synchronize Views**

Graphs of results may be open for one or more streams. For each stream, one or more graphs may be displayed. The graphs may have their zoom, cursor position and visible section manipulated separately or all the graphs may be synchronized. For example, in unsynchronized operation, the open graphs may look like this:

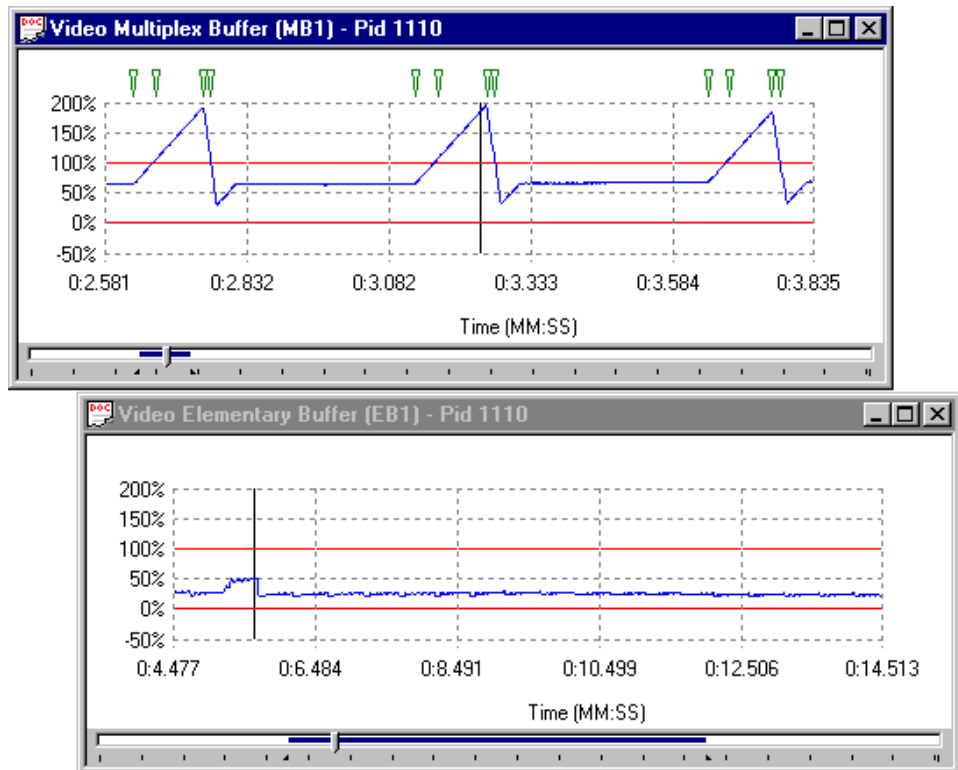

This pair of graphs show different periods in the file at different magnifications.

To synchronize the views, select the Synchronize Views option from the Options menu.

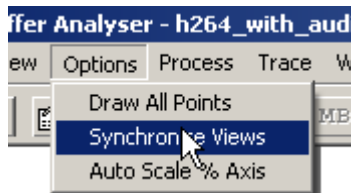

Alternatively, click on the equivalent shortcut button.



This will apply the zoom, cursor, and visible section of the active window to all of the other graphs. While Synchronize Views is enabled a change to any graph is immediately applied to all the other graphs.

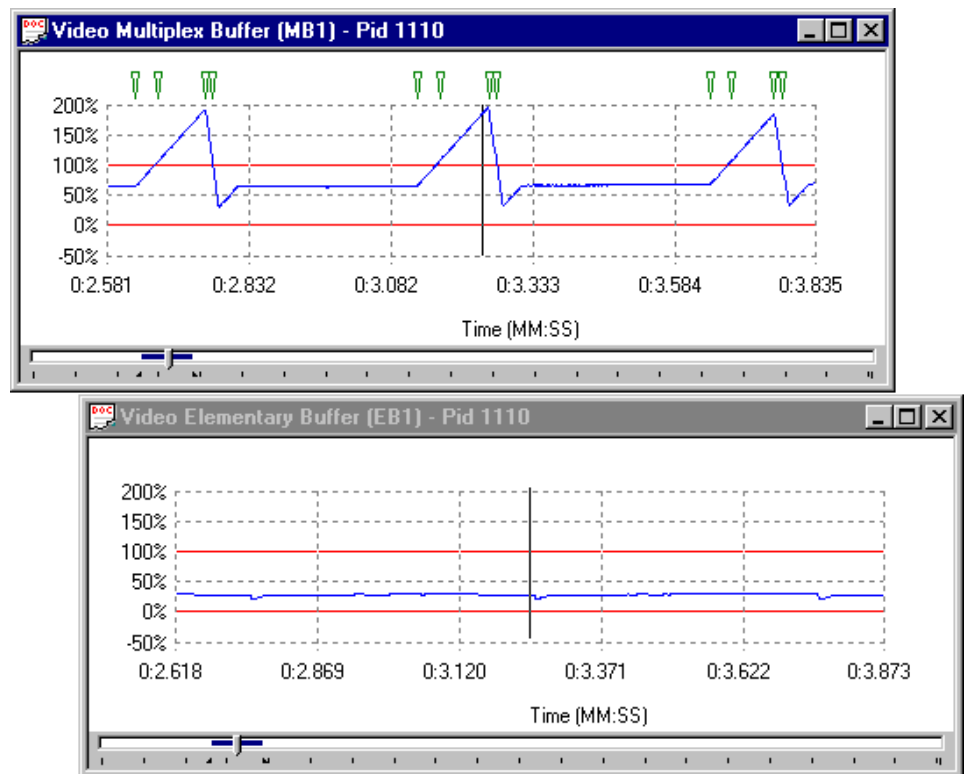

The Trace table can also be synchronized with the other graphs by enabling the Synchronize Views icon. While Synchronize views is enabled, a change in the selected event of the Trace table moves the cursor position of all other graphs accordingly. Similarly, a change in any of the graphs moves the highlighted event of the Trace table accordingly.

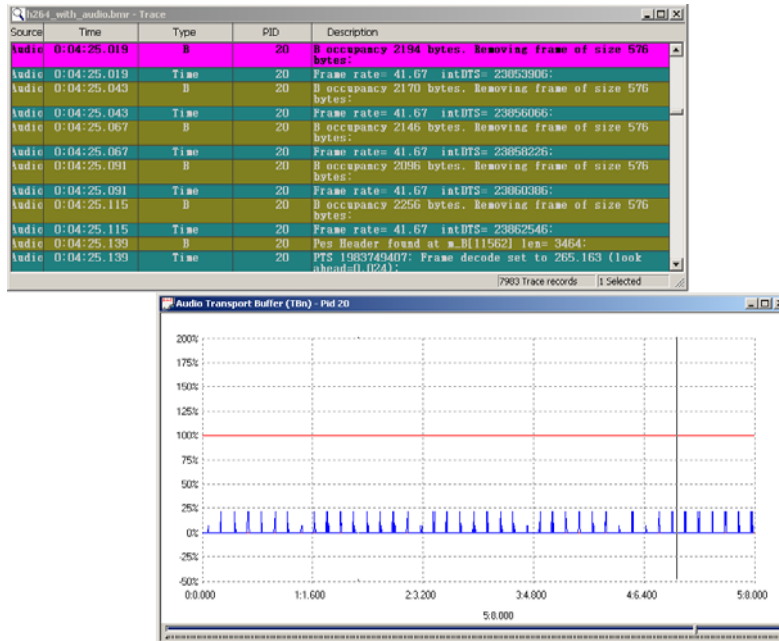

To separate the control of the graphs, disable synchronize views by selecting the menu option or by clicking the shortcut button again.

**Selection** The cursor may be repositioned within a graph by clicking on the required point. This is useful when Synchronize Views is selected as a way of marking the same time in all the graphs for ease of comparison.

**Auto Scale** The scale on the y-axis of the graphs shows space used in the buffer as a percentage. By default, all of the graphs have a vertical scale that goes from -50% to 200%. For example:



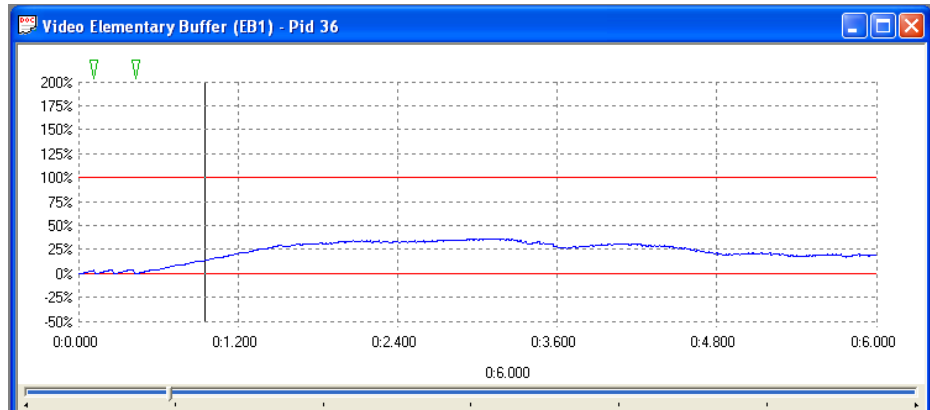

Selecting the Auto Scale % Axis option from the Options menu changes the y-axis for the currently active graph.

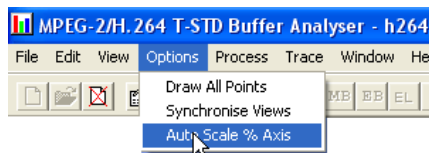

Alternatively, select the equivalent shortcut button.



The y-axis is now drawn so that the full scale contains the range of values in the graph, to the nearest 25%. For example, if the range of values was from 30% to 64%, the y-axis would go from 25% to 75%. The earlier example will be rescaled to look like the following:

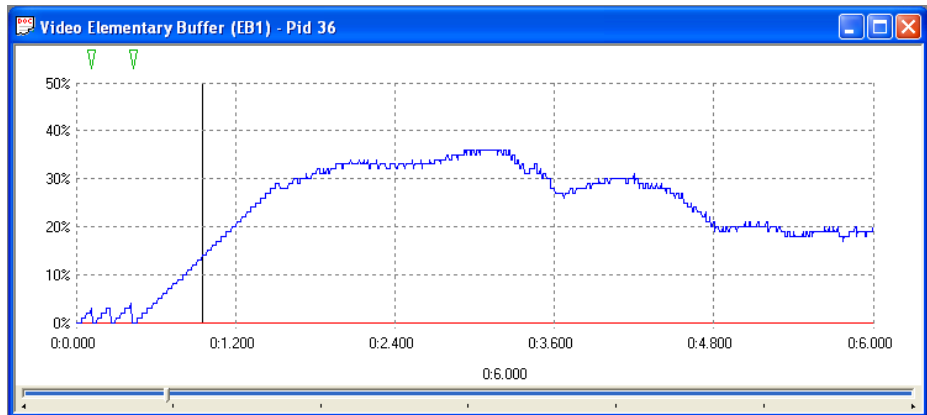

To revert to the default scale, select the menu option or click on the shortcut button again.

**Draw All Points**

The graphs will often contain more data points than can be resolved on the screen. By default, to avoid drawing points on top of each other, the application will plot every nth point. This also speeds up drawing process. How many points to plot is determined from the available width of the graph on the screen and the total number of points to plot.

Use the Draw All Points option to look for outlying points and to resolve the fine detail when zoomed in on the data.

Selecting the Draw All Points option from the Option menu will cause the application to plot every point.

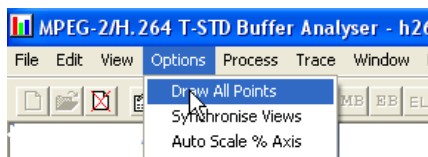

Alternatively, select the equivalent shortcut button.



This may take much longer for larger files than the default option. The option may be disabled by clicking on the shortcut button again or deselecting the option from the menu. This can be done even while still redrawing the graphs.

## Elementary Buffer Graph

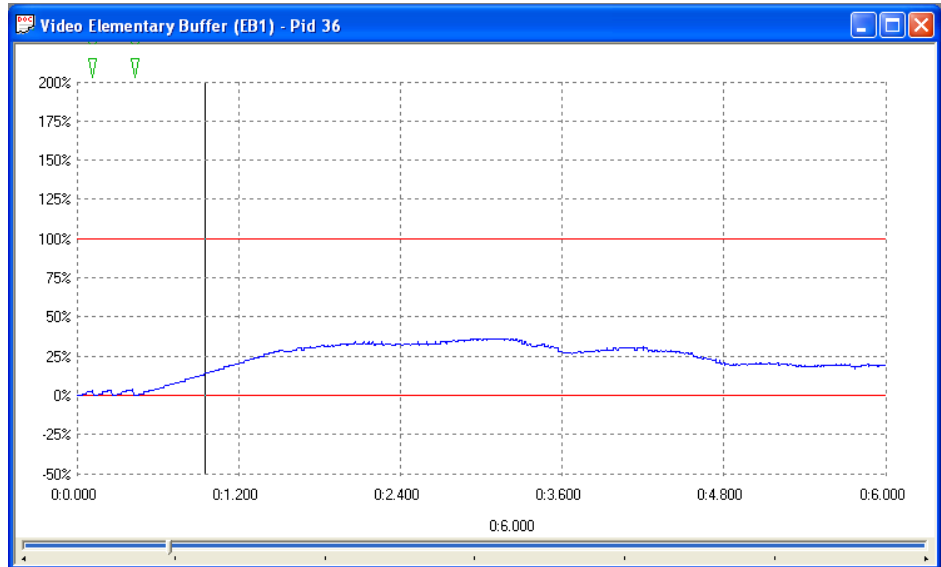

An Elementary Buffer graph can only be opened for Video Streams, since these are the only type that have an elementary buffer.

Elementary Buffers are not allowed to overflow, so the graph of the results never goes above 100%. The graph uses the scale -50% to +250% to make comparison easy.

## Multiplex or Main Buffer Graph

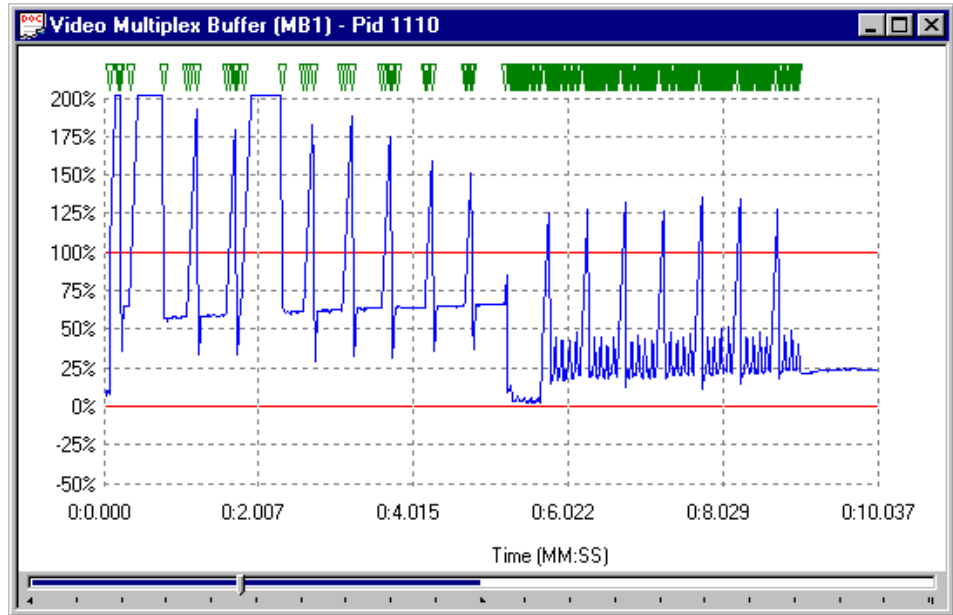

For Video streams this graph shows the results for modeling a Multiplex Buffer. For Audio and System Control streams the graph shows the results for the Main buffer. The title bar shows the stream type.

Here is an example to show the title for a graph of a System Control stream.

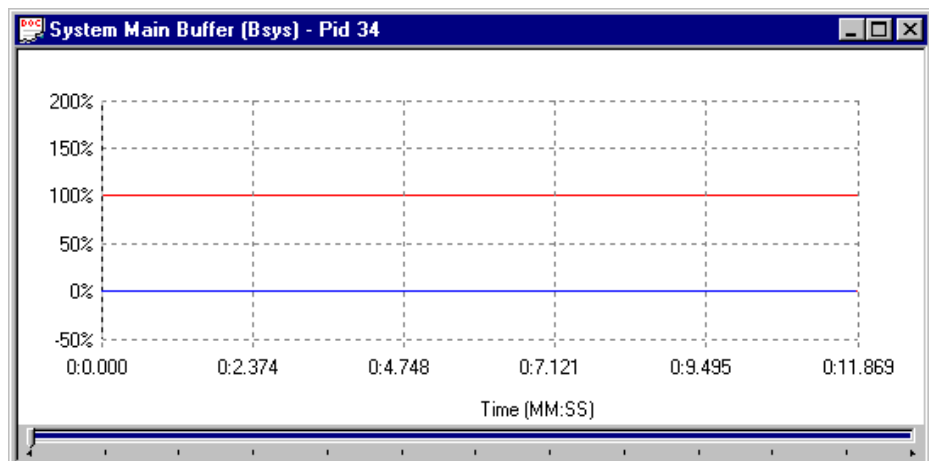

### Transport Buffer Graph

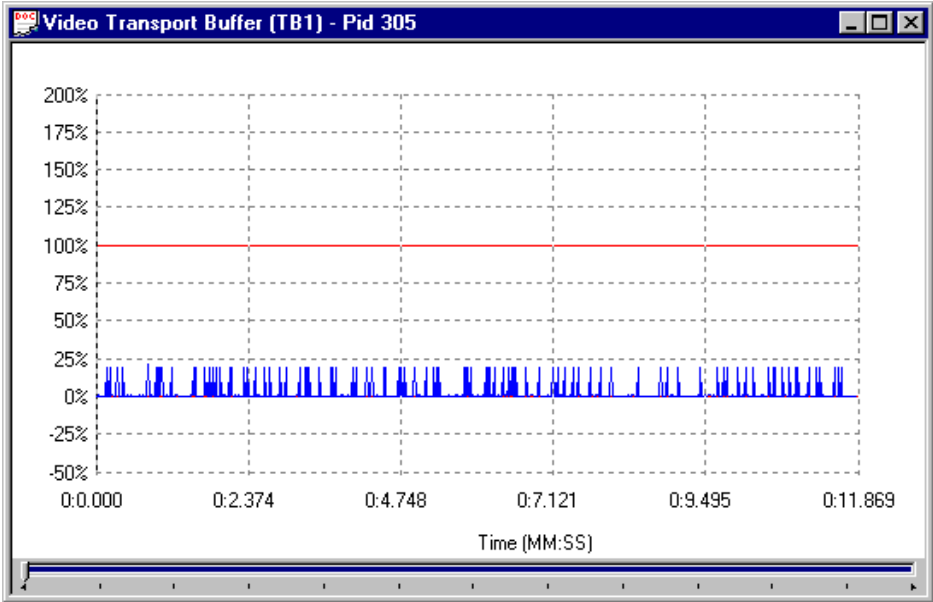

The Transport Buffer graph shows results of modeling the Transport Buffer for Video, Audio, or System Control streams. The type of stream is shown in the title bar. In the above example, the results plotted are for a Video stream carried in PID 305.

Here is an example of an audio stream.

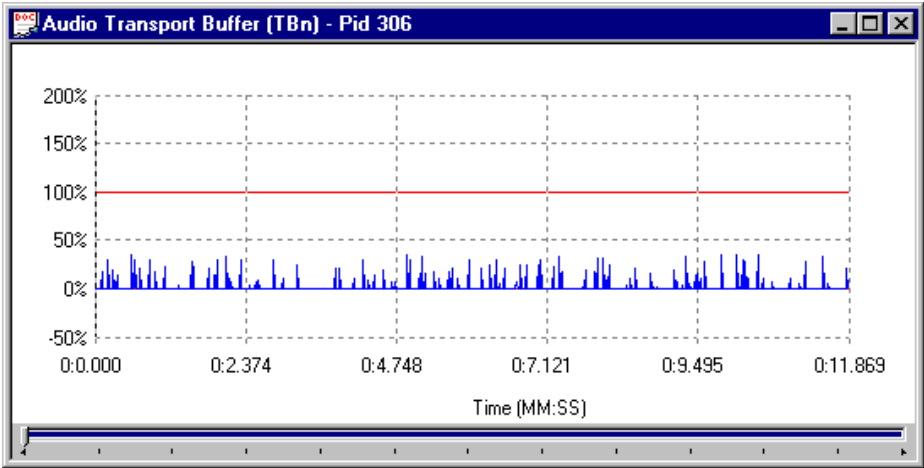





# **Elementary Stream Analyzer**





# Table of Contents

<b>Elementary Stream Analyzer</b> .....	<b>5-1</b>
Starting the ES Analyzer .....	5-2
Opening an MPEG Stream .....	5-3
Understanding the Main Window and Icons .....	5-5
Tree View and Navigation .....	5-8
Header, Extension and Hex Displays .....	5-10
<b>Error Testing Methods and Outputs</b> .....	<b>5-15</b>
Run Through Stream Test Mode .....	5-16
Error Filtering .....	5-17
Status Bar .....	5-23
Regression Testing and Error Log Files .....	5-24
Reports and Field Selection .....	5-27
Demultiplexing Transport Streams to PES or Elementary Output Files .....	5-30
<b>Working with Transport and PES Streams</b> .....	<b>5-31</b>
Using Packet View .....	5-31
Understanding PES .....	5-32
<b>Working with Video Streams</b> .....	<b>5-35</b>
Viewing the Sequence Header .....	5-36
Viewing the GOP and Picture Header .....	5-37
Displaying the Slice and Macroblock .....	5-42
Analyzing Picture Quality .....	5-44
Using the Video Viewer for Picture Analysis .....	5-57
<b>Working with Audio Streams</b> .....	<b>5-61</b>
Understanding MPEG Audio Streams .....	5-61
Audio Player .....	5-62
Understanding Dolby Digital (AC-3) Audio Streams .....	5-68
<b>Working with Program Streams</b> .....	<b>5-71</b>
Viewing Pack and System Headers .....	5-72
Viewing the Program Stream Map .....	5-73
<b>Working with Teletext</b> .....	<b>5-75</b>
VBI (Enhanced Teletext Support) .....	5-76
<b>Advanced Audio Compression</b> .....	<b>5-79</b>
ADIF Stream Forms .....	5-81
ADTS Stream Forms .....	5-89
<b>Closed Caption Analysis</b> .....	<b>5-91</b>
Enabling Closed Caption Analysis .....	5-91
Selecting Closed Caption Analysis Standard .....	5-92
CC-EIA608 Support .....	5-93
CC-EIA708 Support .....	5-94
Dumping Closed Caption Statistics .....	5-98
<b>DVB Subtitle Stream Analysis</b> .....	<b>5-101</b>
DVB Subtitle Data Tab .....	5-103
Page View Tab .....	5-106

## List of Figures

<b>Figure 5-1: ADIF header Information</b> .....	<b>5-81</b>
<b>Figure 5-2: ADIF raw data Information</b> .....	<b>5-82</b>
<b>Figure 5-3: Single channel element Information</b> .....	<b>5-83</b>
<b>Figure 5-4: Coupling pair element information</b> .....	<b>5-83</b>
<b>Figure 5-5: Coupling channel element information</b> .....	<b>5-84</b>
<b>Figure 5-6: Low frequency element channel information</b> .....	<b>5-84</b>
<b>Figure 5-7: Data stream element information</b> .....	<b>5-85</b>
<b>Figure 5-8: Program configuration element information</b> .....	<b>5-85</b>
<b>Figure 5-9: Fill element information</b> .....	<b>5-86</b>
<b>Figure 5-10: ADIF channels (non-standard) information</b> .....	<b>5-87</b>
<b>Figure 5-11: ADIF channels (standard) information</b> .....	<b>5-88</b>
<b>Figure 5-12: ADTS header information</b> .....	<b>5-89</b>

## List of Tables

<b>Table 5-1: Tool Bar icons</b> .....	<b>5-6</b>
<b>Table 5-2: Navigation icons</b> .....	<b>5-8</b>
<b>Table 5-3: Header icons</b> .....	<b>5-10</b>
<b>Table 5-4: Hex Headers Display</b> .....	<b>5-13</b>

# Elementary Stream Analyzer

Elementary Stream (ES) Analyzer is an MPEG (Motion Pictures Expert Group) stream analyzer that allows all MPEG-1 and MPEG-2 streams to be quickly analyzed. Developers of MPEG compliant encoder and decoder systems, or field application engineers (FAEs) supporting MPEG-based products will find ES Analyzer a powerful and easy-to-use tool and debugging aid.

ES Analyzer provides the following facilities:

- Analyze in detail and verify whether MPEG-1 system and MPEG-2, video, and audio streams conform to MPEG standards. (A built-in stream demultiplexer makes it possible to analyze elementary streams embedded in a transport stream. All streams are checked for both syntactic and semantic conformance. Syntactic conformance means conformance with the MPEG language, while semantic conformance relates to the field value and range restrictions.)
- Quickly zoom from transport streams, through PES and video streams into GOP, pictures, slices, and all the way down to the macroblock layer.
- Play out audio streams to MPEG-1, MPEG-2, Layers I and II, Japanese AAC, and Dolby Digital (AC-3) standards.
- Audio play to soundcard.
- Analyze Layer I, Layer II audio data, AC-3 audio, and AAC audio.
- View video output with the incorporated video player and analyze picture data for any frame.
- Produce picture quality analysis data including Quantizer Scale distribution, motion vectors graph in a picture, and macroblock and picture size plots.
- View the coded block patterns that have been extracted.
- Display and analysis of DCT coefficients for each macroblock in a picture.
- View interpreted and hexadecimal view of headers for all streams.
- Display and analysis of DVB Teletext information.
- View and analyze DVB subtitle content.
- View and analyze ATSC closed caption to EIA608 and EIA708 standard.
- View PID spectrum analysis for transport streams.
- Analyze multiple streams in batch mode through the regression testing mode.

- Quickly navigate through stream hierarchy using the powerful and easy to use graphical interface including the Stream Properties summary window.
- ‘Seekback’ at all levels, allowing users to go back in a stream at all levels, thus allow more flexibility in navigation.
- Set a level to report errors, filter them, and also store errors in log files.

---

**NOTE.** *It is assumed that you are familiar with MPEG compression standards and terminology. If you are new to MPEG and want to know about MPEG compression standards and terminology, refer to the documents: ISO/IEC 11172 (Vol. 1, 2, 3 and 4) for MPEG-1 and ISO/IEC 13818 (Vol. 1, 2 and 3) for MPEG-2 basics.*

---

## Starting the ES Analyzer

The program can be started by selecting the Tektronix ES Analyzer option from the Start > Programs menu or by double-clicking on the Tektronix ES Analyzer shortcut on the desktop.

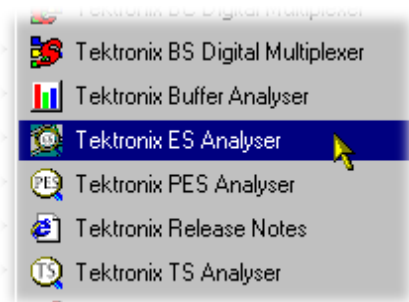

Initially an empty shell window is displayed. It is necessary to open a stream before any screen details can be seen.

## Opening an MPEG Stream

1. To open a file, select the Open... option from the File Menu or select the corresponding icon on the toolbar.

The following dialog box appears:

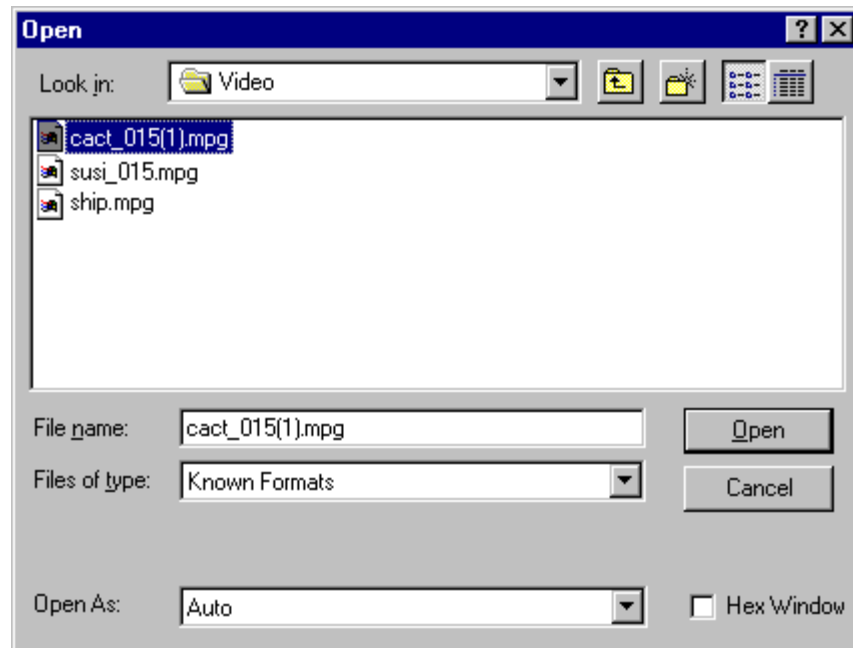

ES Analyzer displays a standard windows Open dialog box with two additional fields: Hex Window and Open As.

2. Select the file you want to open.

The types of files that can be opened are as follows:

- Transport stream files
- PES stream files
- Elementary stream files
- MPEG-1 and MPEG-2 files
- Regression scripts
- Mask files

---

**NOTE.** *If you want ES Analyzer to automatically detect the type of MPEG stream the file contains, let the default Auto remain in the Open as field.*

*If you want to open the file as a specific type of stream and do not want ES Analyzer to detect it, select the stream type in the Open as field.*

*If you open an MPEG stream as an incorrect stream type, numerous errors may be reported and ES Analyzer may also behave unexpectedly.*

*If you open an ATSC stream as auto and the stream contains no PSIP service information, the AC-3 audio may appear as  and not decode. Close the file and reopen with ATSC Stream selected from the Open as field; the AC-3 audio will now decode correctly.*

---

**3.** Enable or disable the hex window.

ES Analyzer parses and demultiplexes the opened MPEG stream, and displays the packet header fields in two formats—interpreted and hexadecimal.

- If you want ES Analyzer to display the packet header fields in both the formats, interpreted and hexadecimal, check the check box next to Hex Window. (The hexadecimal format is displayed in a separate window.)
- If you want ES Analyzer to display the packet header fields only in the interpreted format, let the default remain. (By default, the check box next to Hex Window is clear.)

---

**NOTE.** *If you do not enable the Hex Window when you open a stream, you cannot enable it later when ES Analyzer is parsing the stream.*

---

**4.** Click Open when you are through with this dialog box.

## Understanding the Main Window and Icons

ES Analyzer allows you to view multiple programs and streams simultaneously. The tree view area on the left side displays the stream hierarchy. For the currently selected stream, the details of the header are shown on the right side. Errors, if encountered, are logged in the error log window at the bottom. A summary of the stream parameters is displayed in the Stream Property window. The status bar at the bottom of the window displays the current status and stream characteristics.

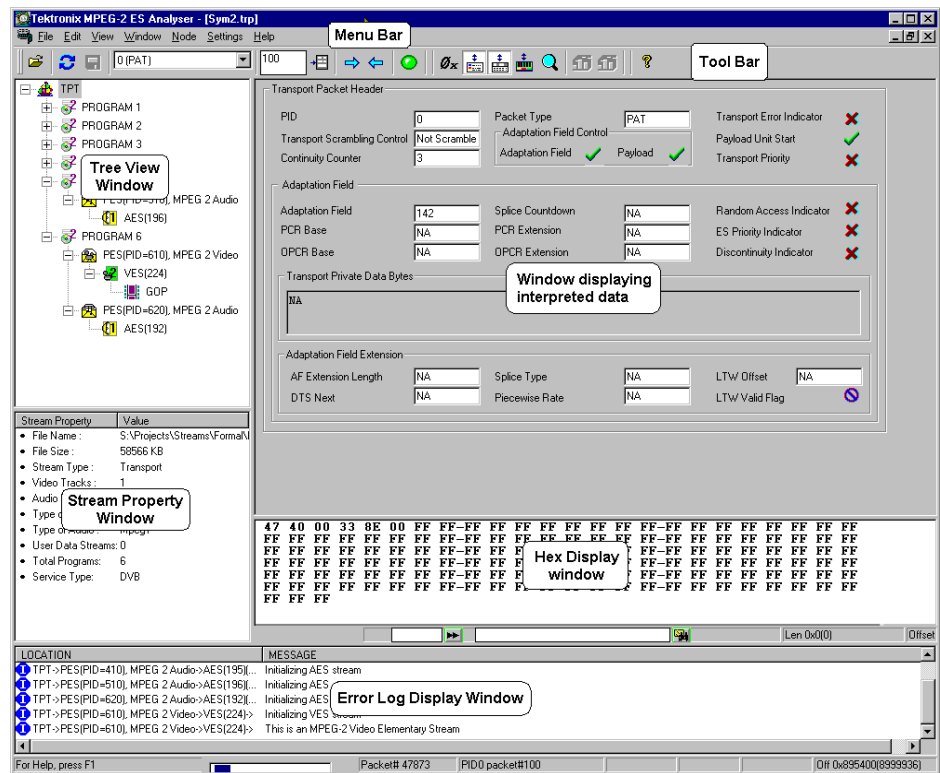

**Tool Bar** The tool bar provides a means of accessing frequently used menu bar commands quickly; each icon represents a menu bar item. Icons will display a tooltip description when the cursor is rested over it. The tool bar illustration below does not show all of the buttons.



The table below lists the function of each icon and also indicates when the icon is available. Availability refers to an icon being enabled or disabled with respect to selected nodes in the left tree view window; disabled icons are 'grayed out'.





You can toggle the tool bar display by selecting/deselecting the Toolbar command on the View menu.

**Table 5-1: Tool Bar icons**

Icon	Function	Availability (Enabled/Disabled)	Menu Bar equivalent
	Opens an MPEG stream, a saved regression file (.REG file by default), or dumped reports	Always enabled	File > Open...
	Restarts analysis from the beginning of the selected parent or child stream	Enabled for all nodes	Node > Intialize
	Extracts a PES, Audio, or Video stream from a multiplexed stream	Enabled for all the embedded stream nodes (PES, VES, AES)	Node > Dump Stream
	Allows navigation to the selected TPT packets; used in conjunction with the Next icon	Enabled for Transport and Program	-
	Enables navigation to the nth packet at TPT node or the nth GOP at GOP node or nth frame at AES node. Used in conjunction with the adjacent button	Always enabled; disabled only for VES node	-
	Allows navigation to the next/previous packet of the selected node	Always enabled; disabled only for VES node, or at end of file	Next/ Previous Packet/ GOP
	Toggles Start and Stop to run through Test mode	Only enabled at GOP level	Start Stop
	Toggles between hexadecimal and decimal display of data in fields	Always enabled	-
	Shows or hides the error log window	Always enabled	-
	Shows or hides the Hex Viewer, which displays data in hexadecimal format	Enabled if Hex Window is checked when opening a stream, otherwise always disabled	-



Table 5-1: Tool Bar icons (Cont.)

Icon	Function	Availability (Enabled/Disabled)	Menu Bar equivalent
	Enables or disables packet view analysis that displays the PID spectrum	Enabled only for PES	-
	Allows zooming into any part of data being displayed; useful when viewing Motion Vector Display in the Slice And MB tab	Always enabled	-
 (left icon)	Shows Frame Size Statistics for different frames within a GOP	Enabled only for GOP node (Disabled if the Picture Player tab is selected)	Frame Sizes
 (right icon)	Shows Slice Size Statistics, i.e., information about the sizes of the slices within a Picture in a GOP	Enabled only for a GOP node from within the Slice And MB tab	Slice Sizes
	Allows viewing the version and copyright information	Always enabled	Help Topics

### Working with ES Analyzer Commands

When using ES Analyzer, you can issue commands in one of three ways:

- By clicking commands on the menu bar; this also includes the keyboard shortcuts, which are shown next to the menu bar entries
- By clicking icons on the toolbar
- By clicking the right mouse button and selecting a command on the quick menu

After you have invoked ES Analyzer, you need to select the bit stream file you want to be analyzed by clicking Open on the File menu or by clicking the appropriate icon on the toolbar. If the bit stream file is a valid MPEG file, ES Analyzer displays the first packet of the top level stream. Now you can use commands, described below, to navigate randomly to any part of the stream. You can also run through a selected embedded stream using the Go command.

## Tree View and Navigation

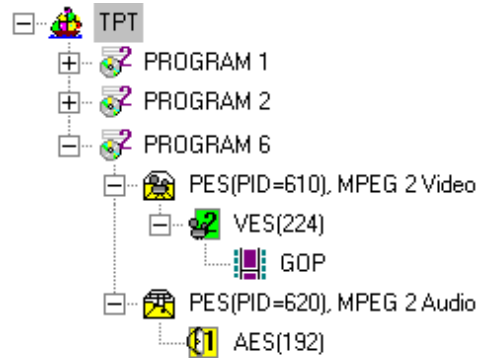





The tree view window displays the stream hierarchy of the currently opened bit stream file. Each node in the tree view represents a level of hierarchy and is displayed with:

- An associated icon (the icon varies depending on the type of stream that the node represents; these are displayed in the following table).
- A tip that describes the kind of stream represented by the node.
- The PID associated with the node, if applicable.

**Table 5-2: Navigation icons**

Icon	Stream type representation
	Transport stream.
	Program stream.
	System stream.
	Packetized elementary stream (PES); PES containing a video or audio stream, respectively.
	Audio stream; an MPEG-1 and/or MPEG-2 audio stream.
	Teletext.
	Dolby AC-3 audio stream.

**Table 5-2: Navigation icons (Cont.)**

Icon	Stream type representation
	Video stream; an MPEG-1 and/or MPEG-2 video stream. If Closed Caption data is detected during analysis, 'CC' is added to the video icon.
	User data stream.
	Group of pictures (GOP).
	DVB subtitle PES.

Suffix 1 and 2 in the Tree View icons (Video and Audio Elementary Streams) refer to MPEG-1 or MPEG-2. Note that MPEG-2 streams can contain MPEG-1 audio information.

**NOTE.** *If packets are scrambled or if stream analysis (AAC Audio) has been excluded by dongle, ES Analyzer does not display them.*

## Navigating through Streams

When an MPEG file is initially opened, ES Analyzer automatically determines the kind of MPEG stream it is. For a valid MPEG bit stream, ES Analyzer opens the tree view with a node for the top level stream contained in the file. By default, the stream hierarchy is expanded to only one level. You can expand/collapse a node by clicking it. You can select the stream to be viewed at any level displayed in the tree view window by simply clicking the left mouse button on the specific node. Automatically, the window on the right is refreshed to display the header and related information for the selected node.

ES Analyzer gives you full flexibility in viewing streams at any level. You can navigate through the stream independently at each level of the stream. For example, you may be viewing the first PES packet of a PES Stream, but in the embedded VES stream, you may be viewing the last GOP that is not contained in the first PES packet.

**Using GoTo, Next and Previous Commands.** These commands are applicable to all types of streams and assume that you have opened a valid MPEG file. Each of these commands can be executed for any node that is displayed in the stream hierarchy tree where each node is either a GOP or a valid MPEG stream (embedded or top level).

- Step forward/backward to the Next/Previous packet or GOP in a video stream for the selected node.
- Position the file pointer to the nth packet or GOP in a video stream or frame in an audio stream for the selected video/audio node.
- Position the file pointer to the nth packet of the selected PID; this is applicable to MPEG-1 system streams and MPEG-2 transport and program streams.
- Position the file pointer to the first packet of the selected node.
- Save the embedded stream corresponding to the selected node in a separate file.
- Toggle between hexadecimal and decimal display.
- Use the Transport Stream PID drop-down list to select a PID and navigate to the selected PID using the Next button.



## Header, Extension and Hex Displays

### Header Display Window

The header display window shows the current header and related information for the selected node in a read-only mode. The fields are interpreted and displayed. The header is not displayed syntactically. Wherever field codes represent specific values, the corresponding value is shown rather than the code itself. For example, in a video sequence, although Chroma format is a two-bit code, it is displayed with the interpreted value of 4:2:0 or 4:2:2 or 4:4:4.

You can view field values in decimal or hexadecimal format by clicking the appropriate icon on the toolbar. One bit fields are displayed using one of three icons:

**Table 5-3: Header icons**

Icon	Field value representation
	One-bit field was set to 1
	One-bit field was set to 0
	One-bit field is not applicable here

Almost all MPEG headers allow stuffing bytes and have marker and unused bits defined in their syntax. Although all these are parsed and checked for correctness, they are not displayed since they do not provide any meaningful information.

Wherever appropriate, ES Analyzer provides visual feedback, by the use of color, to represent different states.

### Extension Displays

Besides this generic structure, individual headers may have special displays. For example, the video sequence header has a lot of information to be displayed in a small area. This is achieved by using tabbed folders for all the MPEG-2 extensions (see the following illustration). The tab corresponding to an extension is disabled if the corresponding extension does not appear in the sequence header.

When an extension appears in the video sequence, its presence is also communicated by the changed color of text (in red) on the corresponding tab.

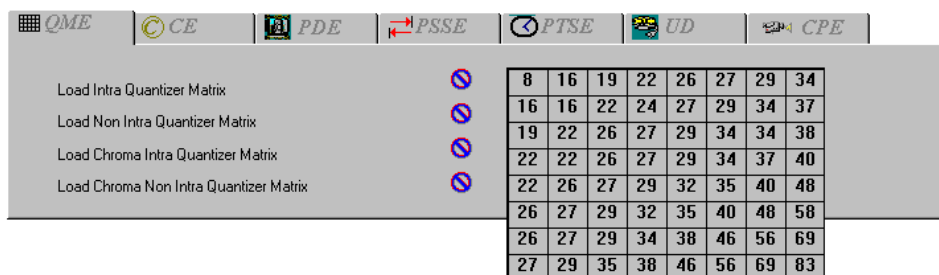

### Hex Display Window

The hex display window shows a hexadecimal dump of header bytes contained in the header being currently displayed in the header fields display window. This is useful if you are used to viewing the headers in the hexadecimal format rather than the interpreted format that is displayed in the header display window. Also able to be displayed are sequence information at VES level and frame information at GOP level (as shown below).

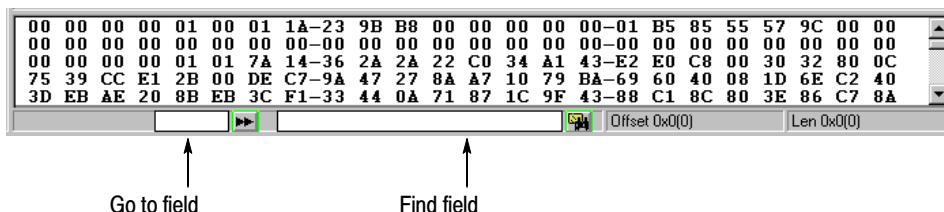

The data collection for the hex display window can sometimes be memory intensive and can affect ES Analyzer's performance. You can turn on the hex display or turn it off according to your requirements by checking or clearing the

check box next to Hex Window in the Open dialog box. If you have not enabled the Hex Window option when opening a stream, you will be unable to open it when ES Analyzer is parsing the stream. However, you can dynamically turn off the Hex Window, whenever you want, by clicking the Show/Hide Hex Viewer icon  on the toolbar if you enabled it when you opened the stream (see details in the *Opening an MPEG Stream* section).

The hex window displays a hyphen (-) after every eight bytes for display purposes. The status bar in the hex window displays the current cursor position's byte offset from the start of the header. If you select a sequence of bytes in the hex window, the size and the byte offset from the start of the selection appears in the status bar when you release the mouse button.

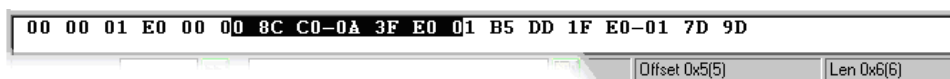

#### **To search for a specific byte pattern in the Hex Window.**

1. Type the pattern in the Find field, on the left of the Find button, on the status bar.
2. Click the Find button.

The specific pattern will be searched from the current cursor position. If the pattern is found, it is highlighted in the hex window. If the pattern is not found, you will hear a beep. The search loops back to the beginning of the file and subsequent occurrences of a pattern can be found by clicking the Find button.

#### **To position the cursor to a specific byte location from the start of the packet header.**

1. Type the byte position in the Goto field, on the left of the Goto button, on the status bar.
2. Click the Goto button.

You will be positioned to the corresponding byte location in the header in the hex display window.

**Summary of Displayed Information (Header and Hex displays).** Table 5–4 summarizes the information displayed in the hex window that corresponds to the information displayed in the header display window.

**Table 5–4: Hex Headers Display**

<b>Header display window information</b>	<b>Hex dump in the hex display window</b>
Transport packet header.	Header data of the current packet.
PES Header.	Header data of the current packet.
MPEG-2 Program stream - Pack Header.	Header data of the current packet.
MPEG-1 System Stream - Pack Header.	Header data of the current packet.
Video stream - Sequence header / sequence extension.	All the video level information which is above the GOP level.
Video stream - When viewing picture at Picture or Slice level display (with video analysis setting set to Macroblock level).	All the information for the currently selected picture. When the first picture is selected in the picture slider, data corresponding to the GOP header (if available) along with first picture data appears. For all pictures other than the first picture in the GOP, only picture data is shown. The subsequently read sequence header and extension data is updated in VES node.
Video stream - Hex data display when viewing picture at Slice level display (with video analysis setting set to Picture level).	Same as above.
Video stream - Hex data display when viewing picture in Picture display form (with video analysis setting set to Picture level).	Same as above, but with the following exception.  Picture data includes only picture header and extension data. No slice or macroblock level data is shown. However, when you go down to the slice level display by clicking the Slices button, ES Analyzer appends slice and macroblock data in the current picture data for the hex viewer. When you return to the Picture display dialog, ES Analyzer continues to show the complete picture data. The pictures for which you do not step down to the slice level, you'll still be shown picture data that includes only the picture header and extension data.
Audio Stream	Both frame header and audio data is shown.





## Error Testing Methods and Outputs

ES Analyzer can error check an entire stream in an automated manner (regression test). Part of a stream, triggered from a node for a specific program, can be manually checked (run through mode).

Regardless of the stream type, testing is only possible at the compression layer; it is the task of Tektronix TS Analyzer and PES Analyzer to test at the systems layer. However, you can still view the headers of the transport and PES packets, but note that no tests are performed (either run-through or regression).

Both test modes will produce screen or file output error messages. Manual test is also possible by examining the various block/slice/vector and picture display menu screens.

Error filters can be applied to the tests, and fields selected to allow diagnostics up to the error point to be dumped in a file for 'pre error point' analysis.







## Run Through Stream Test Mode

This is operated by highlighting the test node - usually the GOP filmstrip icon - of the appropriate program, then clicking on the Start/Stop (green ball) in the top toolbar.

The stream will be run though and errors reported in the error display window.

### Error Display Window

The error display window displays information, warning and error messages generated by the run-through test mode for a specific program node.

LOCATION	MESSAGE
 TPT->{PSI}>	Packet# 14300: Program# 9001: Reading PMT...
 TPT->{PSI}>	Packet# 15500: Program# 9003: Reading PMT...
 TPT->{PSI}>	Packet# 15500: Error in PMT: coded ES_info_length exceeds remaining valid length of the packet
 TPT->{PSI}>	Final CRC value = 3814649399. (should be 0)
 TPT->{PSI}>	Packet# 16485: Program# 9005: Reading PMT...
 TPT->{PSI}>	Packet# 16485: Error in PMT: coded ES_info_length exceeds remaining valid length of the packet

For each message, the following are shown:

- An associated icon that indicates the kind of message (the icons E, I, and S shown below indicate a syntactic error, information, and a semantic error, respectively):



where:

E = protocol syntax (Rules) error.

S = semantic-parameter or data range error.

I = Information only; not an error.

Both E and S should be regarded as errors.

- A string that identifies the exact location in the bit stream where the error was encountered; the format of the string is:

```
(STREAMTYPE) -> (STREAMTYPE, STREAMID) ->
(NODE) (packetNumber)
```

For example, the following string identifies an error in packet number 2 of the MPEG 1 audio stream on PID 210:

```
TPT->PES(PID=210), MPEG 1 Audio->AES0(2)
```

- The message string associated with the message.

Double-clicking a message in the error display window lets you view more detailed information about the message.

## Error Filtering

### Configuring and Filtering Messages for Display

You can configure and filter the kinds of messages you want ES Analyzer to report. You can turn on/off messages of any type (Information, Errors, Semantic checks) to be reported for the entire stream, or any node in the stream hierarchy displayed in the tree view. You can also store the displayed messages in a file or clear the message window.

To configure messages:

1. Click the right mouse button anywhere in the error display window.

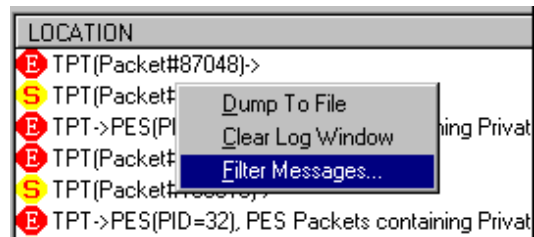

2. Select Filter Messages from the context menu that appears:

The Filter Message dialog is displayed. The dialog box contains two tabbed pages: Global and Node.

**Message Filtering - Global.** The Global Message Filter tab provides settings that can be used to select which messages are enabled and disabled and how many times enabled messages are to be displayed. The rules created are global; that is, they will be applied to all nodes in the active stream. Rules to be applied to a single node (such as PSI, PES, VES) can be added from the Node tab.

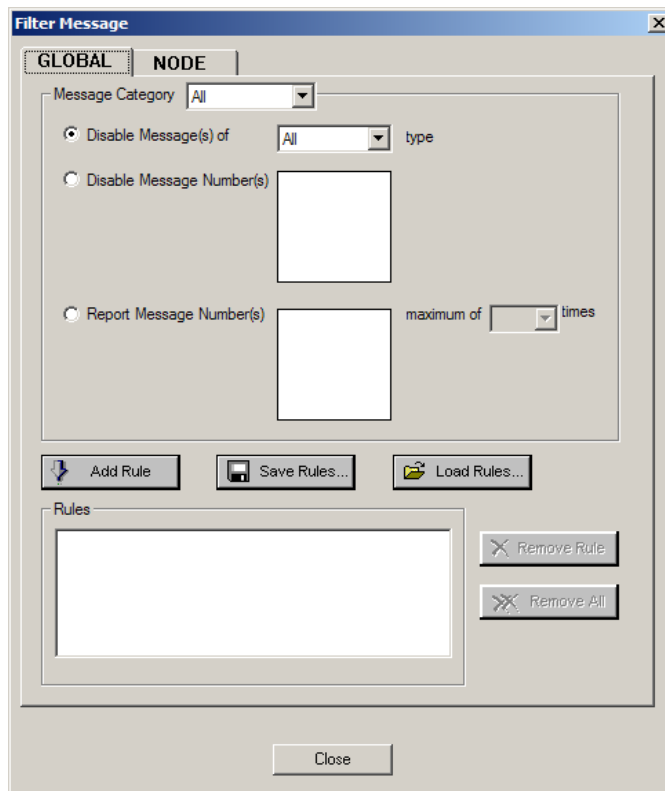

The top half of the Global tab contains:

- A drop-down list from which the category of messages can be selected to which rules are to be applied, and
- Three options for the display of messages.

As rules are created using these fields, they should be added to the Rules text field below by selecting the Add Rule button.

The three options are as follows:

- Disable all messages on the basis of severity, that is, Info (I), Semantic (S) or Error (E).  
Enable the Disable Messages(s) of checkbox, select the type of message to be disabled and press the Add Rule button. Note that the rule is added in the Rules text field.

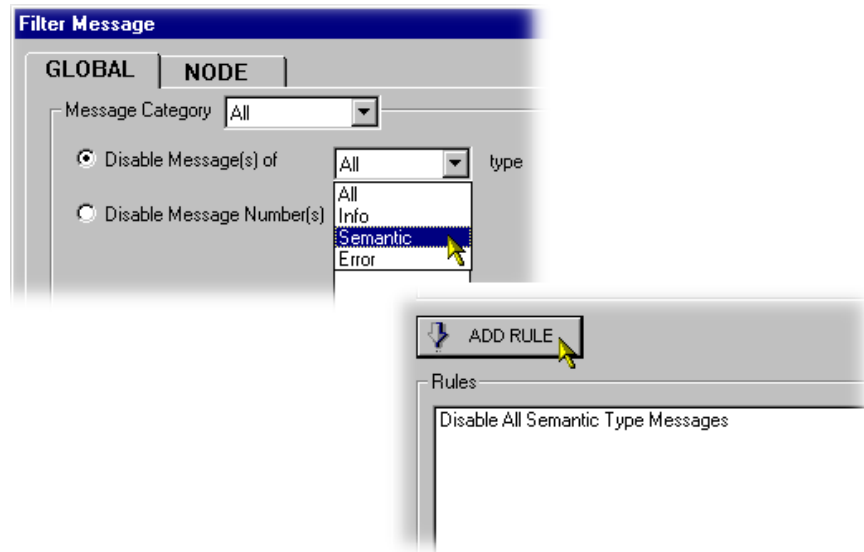

- Disable messages on the basis of message number.  
Each message is assigned a unique number based on the type of streams it is related to; a tooltip will be displayed when the cursor is passed over the message number. Enable the Disable message Number(s) checkbox, select

the message numbers to be disabled and press the Add Rule button. The Shift and Control keys can be used to make multiple selections. Note that the rule is added in the Rules text field.

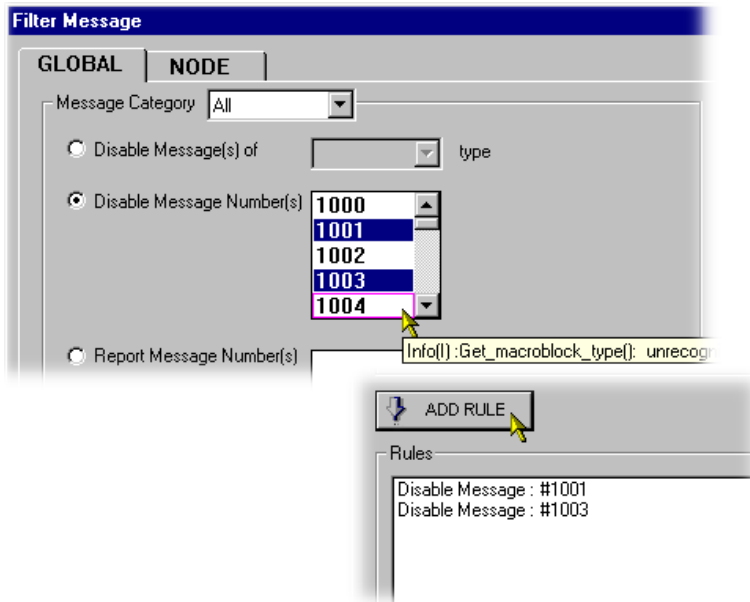

- Report repeated messages only a specified number of times. Enable the Report Message Number(s) checkbox and select the message numbers to be disabled. The Shift and Control keys can be used to make multiple selections. Select the maximum number of times that the message is to be reported and press the Add Rule button. Note that the rule is added in the Rules text field.

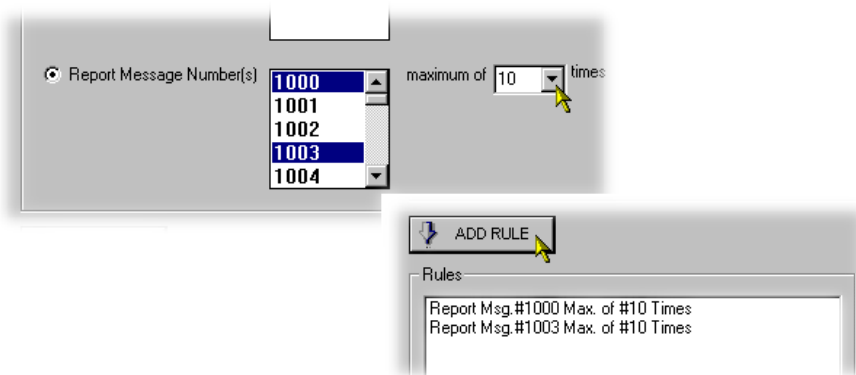

Combinations of message rules can be created; they will need to be created and added one at a time.

Rules can be removed individually (Remove Rule button) or globally (Remove All button). Rules that are already set cannot be edited; they must be removed and recreated.

Rule sets can be saved and reloaded as required using the Save Rules... and Load Rules... buttons.

### Message Filtering - Node.

1. Select a stream in the left scroll window and then select the types of messages you want to be filtered out. By default, all messages are displayed for a stream.

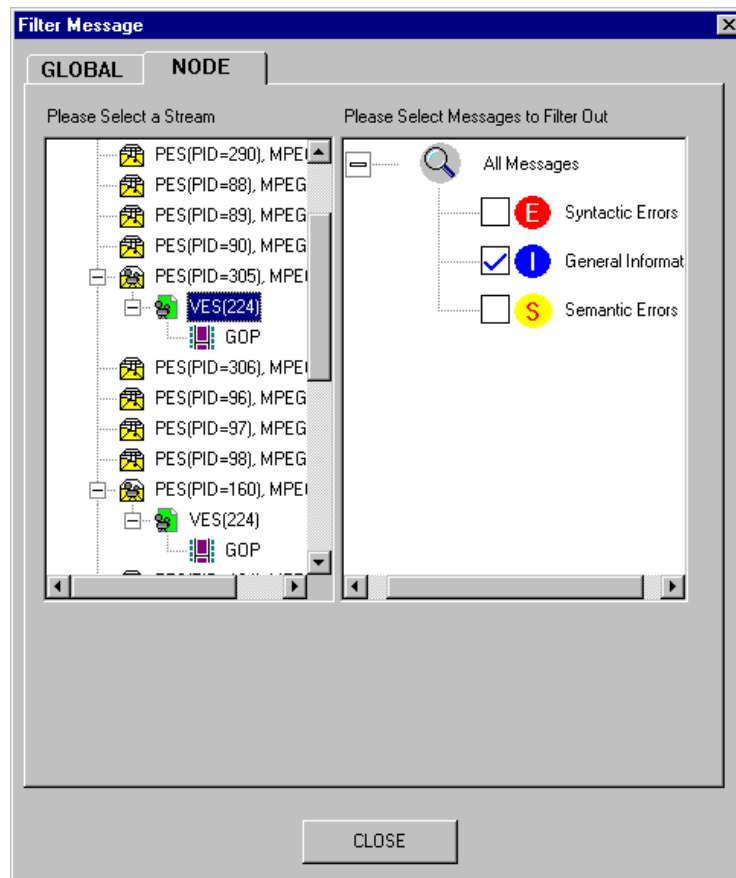

- If you want your message filter(s) to be applicable to all streams opened until now, select it for the entire World. This option will apply the filter(s) to all nodes displayed in the tree view window.

- If you want your message filter to be applicable to all streams, irrespective of whether they are opened or not, click the Set for all Streams button.
- 2. Click OK to accept to changes; Cancel to close the dialog box without applying the changes.

**To store the displayed messages:**

1. Click the right mouse button anywhere in the error display window.
2. Select Dump To File from the menu that appears.

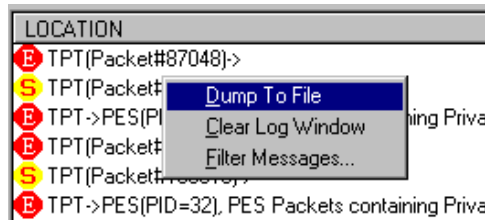

3. The Dump Message dialog box is displayed. Enter the name of the file in which you want to store the messages.
4. Click the Save button when done.

**To clear the windows**

1. Click the right mouse button anywhere in the error display window.
2. Select Clear Log Window from the menu that appears.

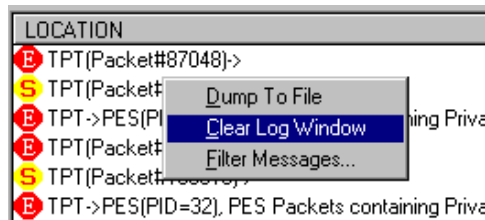



## Status Bar

During regression and run-through mode, progress through the stream is indicated by the status bar at the bottom of the main window. The status bar is split into multiple fields and displays the following:

- A progress bar indicates the approximate byte position in the file for the currently selected stream.

---

**NOTE.** *Since you can view each embedded stream inside a multiplexed stream independently, it is possible that in each embedded stream you may be viewing packets which are far apart in the stream. In such cases, the file pointer will be at different positions for each embedded stream and the file progress bar is updated according to the stream being currently viewed. In addition, the byte offset in the file for the currently displayed unit of data is also displayed in the status bar. For example, when you are viewing a Packetized Elementary Stream (PES), the byte offset of the first byte of the start-code of the currently viewed packet in the opened file is displayed in the status bar. Similarly, when viewing a GOP in a Video stream that is embedded in a Transport stream, the byte offset of the start code of the corresponding GOP in the file is displayed in the status bar. More details are given with the explanation of status bar with each individual stream.*

---

- Characteristics of the stream being currently viewed. These vary with the stream and are described in detail for each stream in subsequent chapters in this book.
- The state of the status bar display can be toggled by selecting/deselecting the Status Bar command on the View menu; that is, View > Status Bar.

## Regression Testing and Error Log Files

With ES Analyzer, you can regression test MPEG streams (with errors being saved to log files) and save data from selected fields to report files for viewing later (see the section Reviewing a Report for details).

### Regression Test Window

To perform a regression test, close the file, if it is open, using the File menu. Select File > New Regression Script.... Note that disk drive icons are displayed on the right side of the directory window; you may need to scroll right to view/access them.

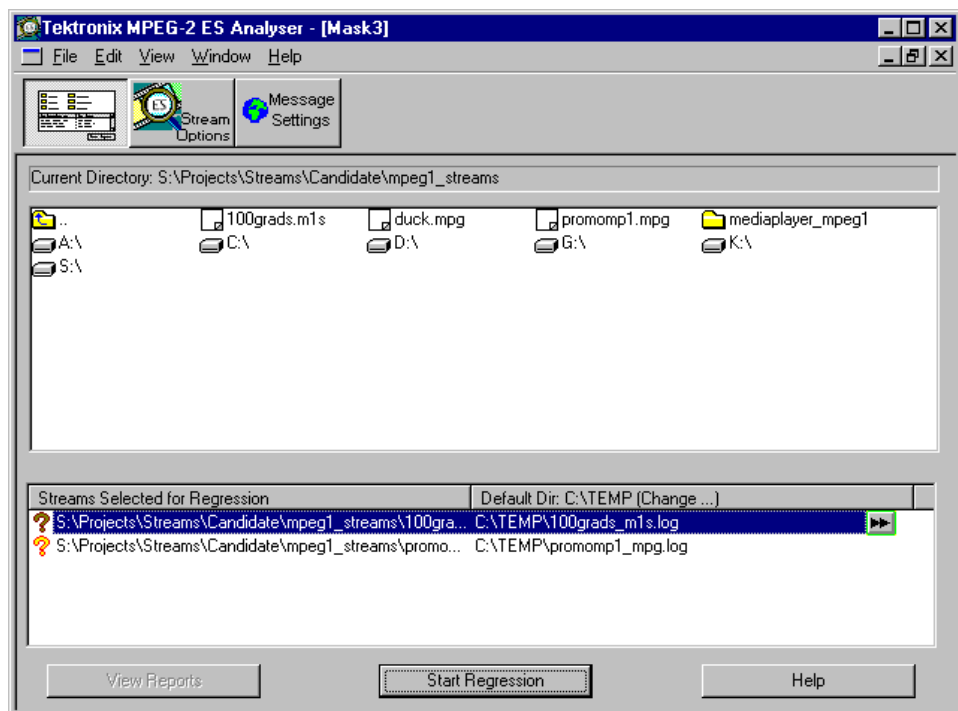

Double-click on the file you require and it should appear in the lower window Streams Selected for Regression with an orange question mark to the left of the file name.

When regression is done, this will turn to a red or green ball, depending on the errors found. A default log file name is entered; it can be renamed by clicking on the double-arrow button to the right of the name. After regression testing, the log file can be viewed by double-clicking on the log file name.

Error messages written to the log file can be controlled via the Message Settings screen.

The button View Reports is only available to show dump/.dat files if they have been set up beforehand (see Select Fields and Reviewing a Report sections).

## Setting up the Regression

You can select multiple streams for regression from the displayed list of files. (To select multiple files, double-click a file or select it and then drag-and-drop it in the lower window.) The streams selected for regression appear in the lower window.



For each stream, the following are displayed:

- File name.
- Default log file where the messages for the stream will go. You can change this by clicking the icon displayed next to the log file name. ES Analyzer displays a default directory where all log files are created that store the results of the regression. You can change the directory for storing log files by clicking the Default Dir... button.
- The stream type. Initially this is not known and is set to Unknown. Once the regression is complete, this is updated to reflect the type of stream that the file contains.
- An icon indicating the state of the stream. Initially, when a file is selected, the icon appears as a question mark indicating an unknown status. After the stream is regression tested, the icon changes to red if the regression reported errors, or changes to green if there were no errors.

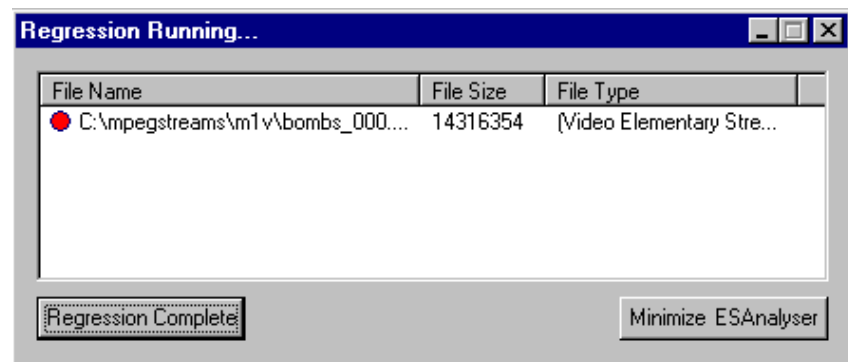

For a regression test, you can also select embedded streams that correspond to nodes in the tree view for a stream hierarchy. You can do this by clicking the Streams Option button in the regression test window; see *Reviewing a Report* below. This displays the settings for the current stream. By default, the tests are enabled for all types of streams, which you can disable. Saving a regression script also saves these settings.

### **Running the Regression**

Once you have set up a regression script, you can run it by clicking the Start Regression button. A status window displays the continuous status of the regression. If you want, you can cancel the regression anytime by clicking the Cancel Regression button in the status window. When the regression is complete, the state of the regression run on each stream is displayed in a dialog box through the changed icon which is red (for failure) or green (for success), and the updated file type. The icon remains a question mark if the file was not a valid MPEG file.

### **Viewing and Saving Results**

You can view the error log file created for any stream after it has been regression tested by double-clicking the specific bit stream file in the regression test dialog box. You will need to associate files of the type \*.log with a text editor of your choice. You may do so through the Explorer. Click View > Options to display the Options dialog, and then click the File Types tab. By default, ES Analyzer opens the log files with the application with which they are currently associated.

You can save the regression script and the results in a regression script. To save the file, choose Save As from the File menu. The file is saved as a binary file and also saves the regression results. You can reload the regression file including the results of the last regression whenever you want. Regression can also be run on a previously saved regression script file.

### **Message Settings**

Messages sent to the log file can be controlled through the Message Settings dialog box. Rules to be applied to messages can be created as required. The operation of this dialog box is similar to Message Filtering as described on page 5-17.

## Reports and Field Selection

You can save and review reports consisting of field value dumps of specific fields when you regression test a stream. To review a report, it must first be created by selecting the fields to be viewed, then setting up and running the regression, and finally selecting the View Reports button (it is also possible to select and open multiple reports).

### Creating a Report

A regression report is packet-by-packet details listed with information fields you can choose. A report is not an error list, although errors detected may appear in it. A report can be used to examine run-ups to problems (pre-trigger).

Before starting a regression test, select the Stream Options button in the Regression test window. Ensure that the Dump Fields check-box is enabled and select the adjacent Select... button. You can then add the fields to be listed in the dump file columns (individual fields or all fields).

You can check the dump in file box and name your dat file or use the default VES.dat or AES.dat.

Do this for video & audio elementary streams.

#### To select fields.

1. Click the Stream Options button in the regression test window to display the following screen.

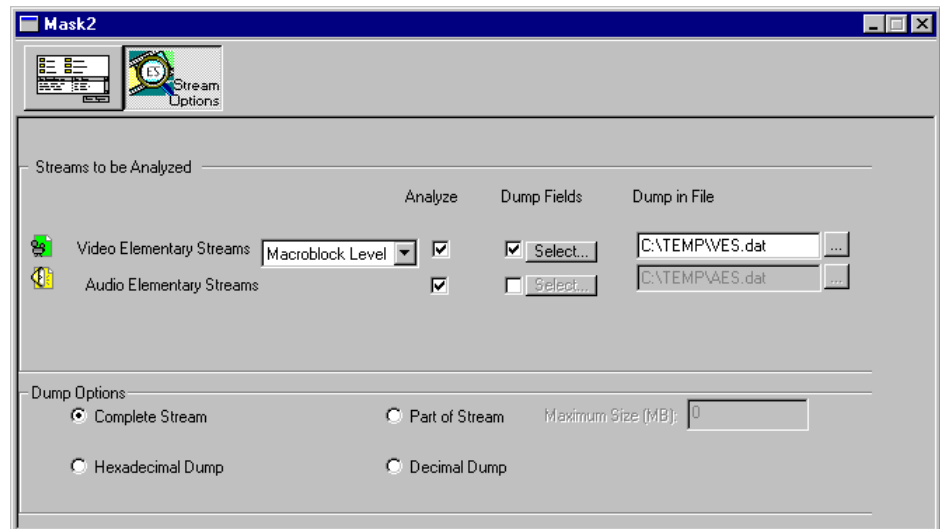

2. Enable and disable the streams using the checkboxes in the Analyze column.

Deselect the streams you don't want ES Analyzer to analyze. By default, all the streams are selected.

3. If you want to analyze Video Elementary Streams, you may either select Macroblock Level or Picture Level from the adjacent drop-down list.
4. Select the streams for which you want to dump data by enabling the checkbox under the Dump Fields column.
5. Click the highlighted Select... button to display the Select Fields dialog box.

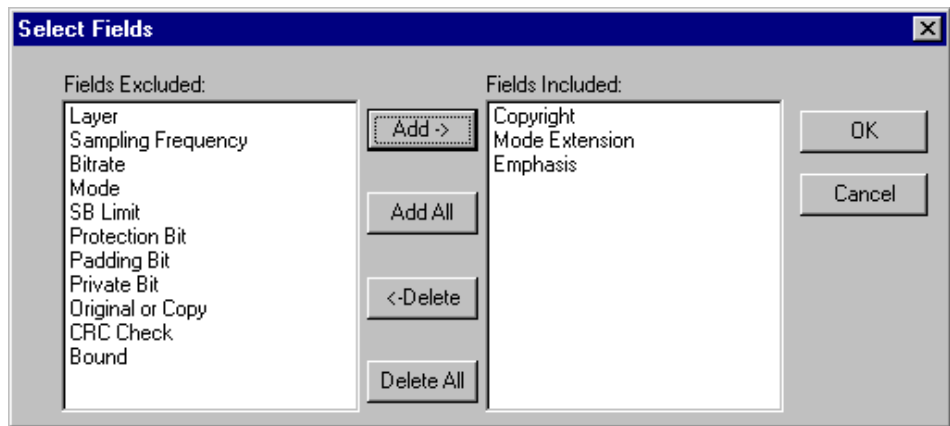

6. Finalize the list of names by adding/deleting the field names in the Fields Included list box and click OK.

You may also double-click a field name displayed in the left list box to include it in the right list box.

- If you have selected a video elementary stream, ES Analyzer also displays options in the Select Fields dialog box.

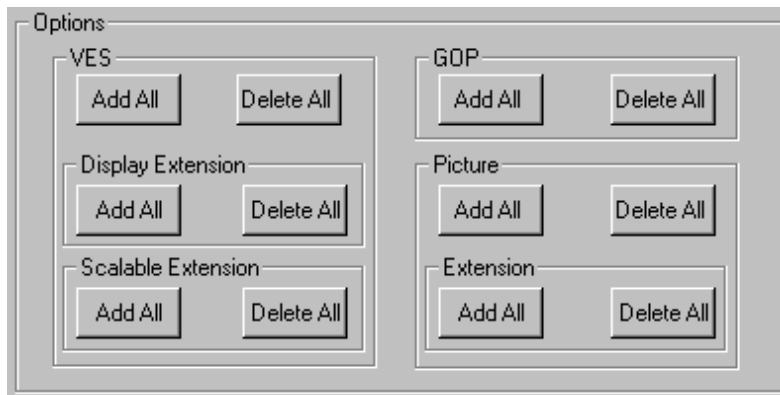

You may click the appropriate buttons to select fields specific to these options. This is a quick way to add/delete specific fields into the Fields Included list box; otherwise, you will need to manually find and add fields from the Fields Excluded list box.

For example, if you have added all the fields from the Fields Excluded list box, and now want to delete VES-related fields from the Fields Included list box, you may click the Delete All button in the VES section. You can also click the Add All button under Display Extension to add related fields to the Fields Included list box.

**7. Specify the file into which you want the fields to be dumped.**

You may type the filename (\*.dat) or select one by using the browse button next to the default filename.

**8. Specify the dump options.**

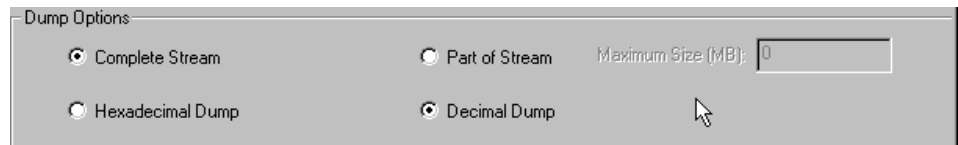

The screenshot shows a dialog box titled "Dump Options". It contains four radio buttons arranged in two rows. The first row has "Complete Stream" (selected) and "Part of Stream". The second row has "Hexadecimal Dump" and "Decimal Dump" (selected). To the right of the "Part of Stream" radio button is a text field labeled "Maximum Size (MB):" containing the number "0". A mouse cursor is visible over the "Decimal Dump" radio button.

If you select Part of Stream, the Maximum Size (MB) field is enabled and you'll need to specify the size of the stream from which the fields will be dumped.

Once you have specified the fields, return to the regression test window by clicking the button next to the Stream Options button.

**Reviewing a Report**     A sample report looks like this:

```
Collecting Statistics for
"C:\mpegstreams\mls\bird4.mpg"
Date 04/02/98           Time: 16:38:42
```

Packet No.	SCR	Fixed Flag	Audio Bound
1	0	1	1
2	1083	1	1
3	2167	1	1
4	3250	1	1
5	4334	1	1
6	5417	1	1
7	6501	1	1
8	7585	1	1
9	8668	1	1
10	9752	1	1

(Note that these 'dump' files have the default extension of .dat.)

## Demultiplexing Transport Streams to PES or Elementary Output Files

It is possible to select a given stream node in navigation view (such as PES video/audio) or VES audio/video (but NOT gop). The diskette icon will highlight on top toolbar at the left when the function is available. Select the icon, name the dump file and select it's type if required. ES Analyzer will then create a PES or elementary stream.

This stream can be loaded back into the ES Analyzer to be checked, and then it can be used as input to Tektronix Multiplexer application to create a transport stream with SI/PSI to your specifications.



# Working with Transport and PES Streams

## Using Packet View

ES Analyzer displays transport packets in a specific way that is useful for analyzing the Transport stream and also for quickly accessing a packet at random.

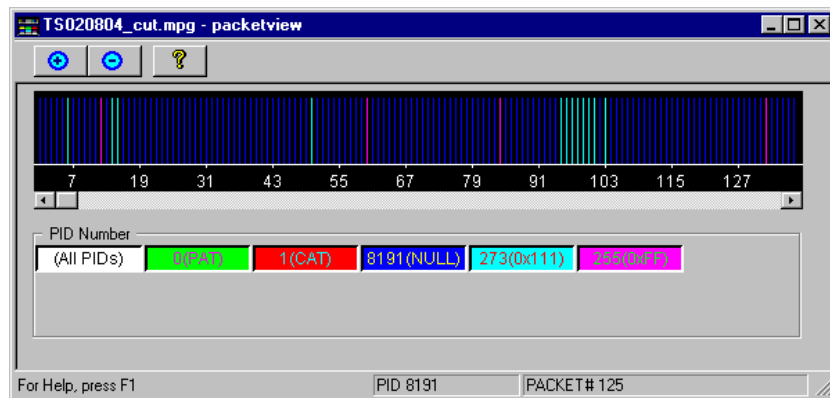

The packet view window can be displayed by clicking the Show/Hide Packet



View icon on the toolbar. A window appears that shows a spectrum of the packets in the order in which they appear in the transport stream. Each PID is assigned a color and each packet is represented using a single line of the corresponding color. By double-clicking the spectral line for any packet, you are positioned to the corresponding packet in the main window of ES Analyzer.

Packet View communicates with ES Analyzer's main window through OLE. You can selectively turn on/off the display of spectral lines for any PID in the Packet View by clicking the corresponding color index in the Packet View dialog. The color index is also a toggle for display. You can also view distance graph between packets of the same PID by just viewing spectral lines of the corresponding PID. To switch back to displaying all PIDs, double-click the All index (represented by white color).

**NOTE.** When you first open Packet View, it displays just the front page of the stream, so that not all of the PID numbers present in the stream are displayed in the button boxes below the main display. If you want to see them all, drag the horizontal scroll bar pointer to the far right; all of the PID number buttons will then be displayed (this could take a few seconds for large stream files).

Packet view does not operate when a program node is highlighted; it works in all other nodes in navigation view.

---

## Understanding PES

A Packetized Elementary Stream (PES) as the name suggests is composed of contiguous packets of an elementary stream with packet headers, as shown in the following illustration, prepended to the packet. A PES occurs only in MPEG-2 streams and its structure has been adapted from the packet structure of the MPEG-1 System stream.

For more information on PES streams, refer to the ISO/IEC 13818-1 document.

An embedded stream is checked when you navigate through one; for details, see the Navigating through Streams section in the *Getting Started* chapter.

For PES streams, you can:

- Run through the stream; see details in the Navigating through Streams section in the *Getting Started* section.
- View packet headers with their decoded fields.
- View an embedded elementary stream.
- View PES extension (if received).

### Explaining the Status Bar Display

The status bar, for PES streams, displays the following:



- Packet number, which is the number of the current packet in the PES stream.
- Byte offset in the file, which is the first byte of the Pack header being currently viewed in both the hexadecimal and decimal formats.



## Working with Video Streams

ES Analyzer performs detailed checks on MPEG Video streams. Video streams are complex with an embedded hierarchy. Structurally, a Video stream consists of a video sequence that has a start code, end code, sequence header, and any number of group of pictures (GOP). Each GOP consists of a GOP header and a group of pictures. Pictures may be of different types (I, B, or P). Pictures can also be frame pictures that correspond to progressive video or field pictures that correspond to interlaced video. Pictures are broken down into a slice structure and each slice consists of macroblocks.

For more details, you may want to refer to the documents ISO/IEC 11171-2 and ISO/IEC 13818-2 that describe the MPEG-1 and MPEG-2 video standards.

Using ES Analyzer, you can:

- View the sequence header along with the extensions.
- Navigate through a stream; see details in the *Navigating through Streams*, page 5–9.
- Run through a stream with the option of analyzing the stream at the picture level or at the macroblock level.

When analyzing a group of picture, you can:

- Randomly access any picture within the group.
- View the picture type spectrum and picture size plots.
- Zoom into any picture and see its details at the slice or macroblock levels, or view the encoded picture. You may also use the video or picture player to play the entire video and pause at any picture when you notice a degradation in quality; you can then review the details of this picture down to the macroblock level. ES Analyzer provides an easy mechanism to switch between the Picture display and the data analysis display windows.
- Select any macroblock and examine its detailed coding.
- Perform picture quality analysis with special displays of quantizer scale distribution, slice size distribution, macroblock-size spectrum and motion vector plots.
- Interpret any video descriptors received in the higher level streams and validate them against the stream.

When analysis with the DCT option is enabled, you can:

- View 8x8 coefficients for all macroblocks within a picture.
- View coefficient tables for y, cr, cb, luma and chroma pixel data.

## Viewing the Sequence Header

The sequence header is interpreted and displayed as shown below.

---

**NOTE.** Placing the cursor over either *Load Intra Quantiser Matrix* or *Load Non-Intra Quantiser Matrix*, displays the applicable quantizer matrix. The check mark icon indicates that the matrix was received in this sequence header.

---

For MPEG-2 streams, an optional sequence extension and user data may also be received. User data is displayed as a hex dump. If data is in the ASCII format, the ASCII equivalent is displayed next to the hex dump.

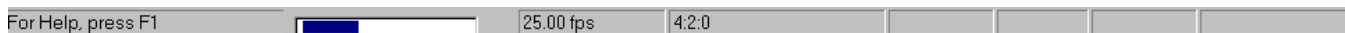

The picture rate, chroma format, and the video type (NTSC/PAL/Unspecified, etc.) appear in the status bar when the sequence headers are displayed.

The information whether the stream is an MPEG-1 or an MPEG-2 stream is displayed in the tree view window as a single numeral (1 or 2) on the node icons.

Within a sequence, you can view the GOPs by clicking on the GOP icon in the left side hierarchy view of the stream. The GOP node appears below the sequence header node.

## Viewing the GOP and Picture Header

When displaying a GOP, ES Analyzer shows you a window with three tabs, as shown below.



Briefly, the contents of each tab are explained below. For details, see the specific sections: *Displaying the GOP Header*, *Displaying the Slice and Macroblock*, and *Using the Video Viewer for Picture Analysis*.

The GOP tab displays the following:

- GOP header data.
- A slider for the pictures in the GOP. The slider can be used to randomly access any picture within the GOP; the slider moves in steps of two to facilitate working with large GOPs. The slider lists the pictures in the received (decoding) order.

GOP position transport controls lie to the left of the slider bar



Using these controls, any picture can be selected within the GOP. The controls include Start and End GOP controls and Next and Previous I frame jump controls. Note that the I frame controls only works in streams where multiple I frames are present between GOP sequence headers.

- Picture header display for the picture selected in the slider.
- Picture extensions (applicable only to MPEG-2).

The Slice and MB tab:

- Takes you inside a specific picture and provides detailed information down to the macroblock level.
- Allows you to generate picture quality plots.
- Allows you to view a picture frame by frame and view macroblock level data for a selected macroblock in the picture.

The Picture Player tab allows you to play and view the video output on your screen.

---

**NOTE.** ES Analyzer synchronizes the picture being currently displayed by the video viewer with the picture/data that is displayed on the other tabs: GOP And Picture and Slice And MB. For example, if you select a macroblock and switch from the picture display to the other picture-quality analysis tabs, the same macroblock remains selected for easy identification.

As an aid to locating a stream, you can click on any open GOP icon in the tree view to switch picture displays in the stream multiplex.

---

### Displaying the GOP Header

The GOP header is an optional header and it is displayed, as shown below, when received.

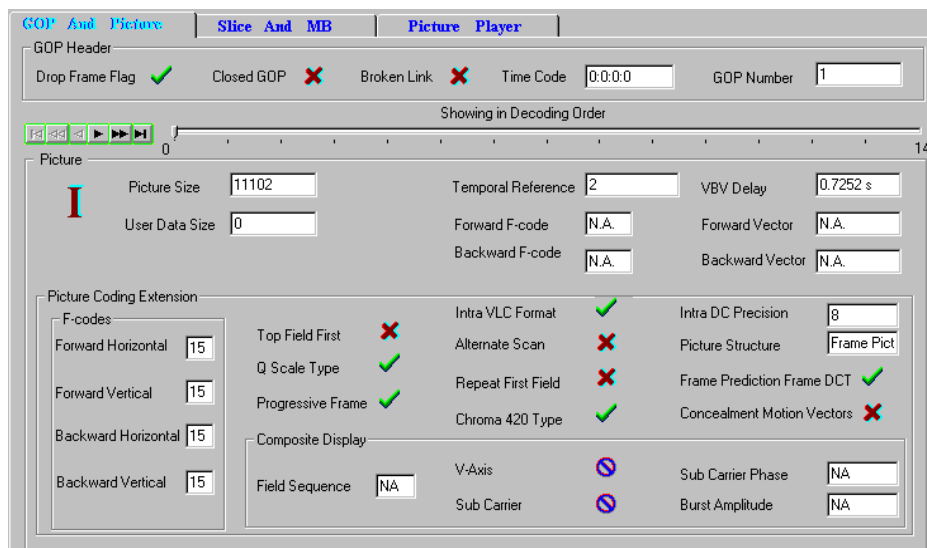



The lower part of the display also shows the picture extensions that have been received.



**Video Analysis Settings.** Analysis of GOPs can be carried out at picture level or macroblock level. This will affect the speed at which the ‘next GOP’ is analyzed. The setting is selected from the Video Analysis Settings dialog.

Select Menu Bar > Settings > Video Analysis. The following dialog is displayed:

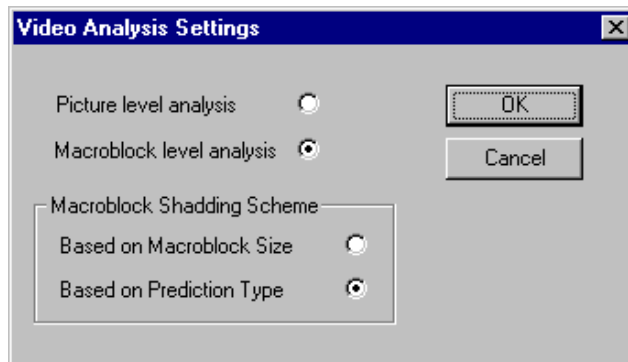

Picture level analysis provides faster analysis but error reporting at the macroblock level is suspended. Macroblock level analysis provides error reporting but at the cost of analysis speed.

**Status Bar (in GOP mode).** When ES Analyzer displays the GOP and picture headers, the status bar, as shown below, displays the:

- Picture rate
- Chroma format
- Video Type (NTSC/PAL/Unspecified etc.)
- GOP number of the current GOP
- Picture number of the currently selected picture, relative to the current GOP (the first picture is given the offset 0.)
- Picture display number, which gives the picture number in display order, relative to the first GOP received. This represents the actual picture Display number. It is calculated by adding the temporal reference of the current picture to the cumulative picture display number prior to the GOP.

**Displaying the Picture Header**

The GOP header tab has a slider for selecting the picture whose details you want to display. The header for the selected picture is displayed below the GOP header in the same dialog box as shown in the earlier illustration.

**Displaying the Picture Extension**

For MPEG-2, several picture extensions may be received. The picture coding extension is always displayed, while the other picture extensions are displayed on tabbed folders, as shown below. The tabs for each of these extensions are enabled and the text on the tab appears in red, only if the corresponding extension is received in the stream.

The screenshot shows a set of tabs for picture extensions: QME, CE, PDE, PSSE, PTSE, UD, and CPE. The CE, PDE, and PSSE tabs have red text, indicating they are active. Below the tabs is a table with four rows of options and a 7x7 grid of numerical values.

Load Intra Quantizer Matrix		8	16	19	22	26	27	29	34
Load Non Intra Quantizer Matrix		16	16	22	24	27	29	34	37
Load Chroma Intra Quantizer Matrix		19	22	26	27	29	34	34	38
Load Chroma Non Intra Quantizer Matrix		22	22	26	27	29	34	37	40
		22	26	27	29	32	35	40	48
		26	27	29	32	35	40	48	58
		26	27	29	34	38	46	56	69
		27	29	35	38	46	56	69	83

All tabs with red text represent extensions that have been received for the current picture. The next section describes each extension and its interpretation.

**Explaining the Picture Extensions.**

QME (Quantizer Matrix Extension)	<p>This allows the quantizer matrices to be downloaded for any picture.</p> <p>At most four matrices can be downloaded, namely, intra-quantizer matrix; non-intra-quantizer matrix, chroma intra-quantizer matrix, and chroma non-intra-quantizer matrix.</p> <p>The QME tab displays through a check mark the matrices that were downloaded. A downloaded matrix is displayed when you move the mouse over the name of the specific matrix.</p>
CE (Copyright Extension)	This indicates any copyrights on the video. The copyright field is interpreted and displayed.
PDE (Picture Display Extension)	This extension gives display extensions for MPEG-2 video.
PSSE (Picture Spatial Scaleable Extension)	This is received when the spatial scalability of MPEG-2 video is used in the video stream.
PTSE (Picture Temporal Scaleable Extension)	This extension is received when the temporal scalability of MPEG-2 video is used in the video stream.
UD (User Data)	This displays any user data associated with the picture in hexadecimal format. If the data represents ASCII text, the ASCII text is also interpreted and displayed.
CPE (Camera Picture Extension)	

**NOTE.** *These tabs will only operate if the appropriate extensions are present within the stream under test.*

*All four matrices will only display if they are downloaded with certain stream types for example, HDTV streams.*



- indicates that only the default matrix will be displayed.

## Displaying the Slice and Macroblock

ES Analyzer allows you to take a microscopic view of a picture by letting you view the picture's slice and macroblock structure.

### To view slice details of any picture:

1. Select the picture by using the picture slider on the GOP And Picture tab.
2. Click the Slice and MB tab.

The macroblocks for the selected picture are displayed as shown below:

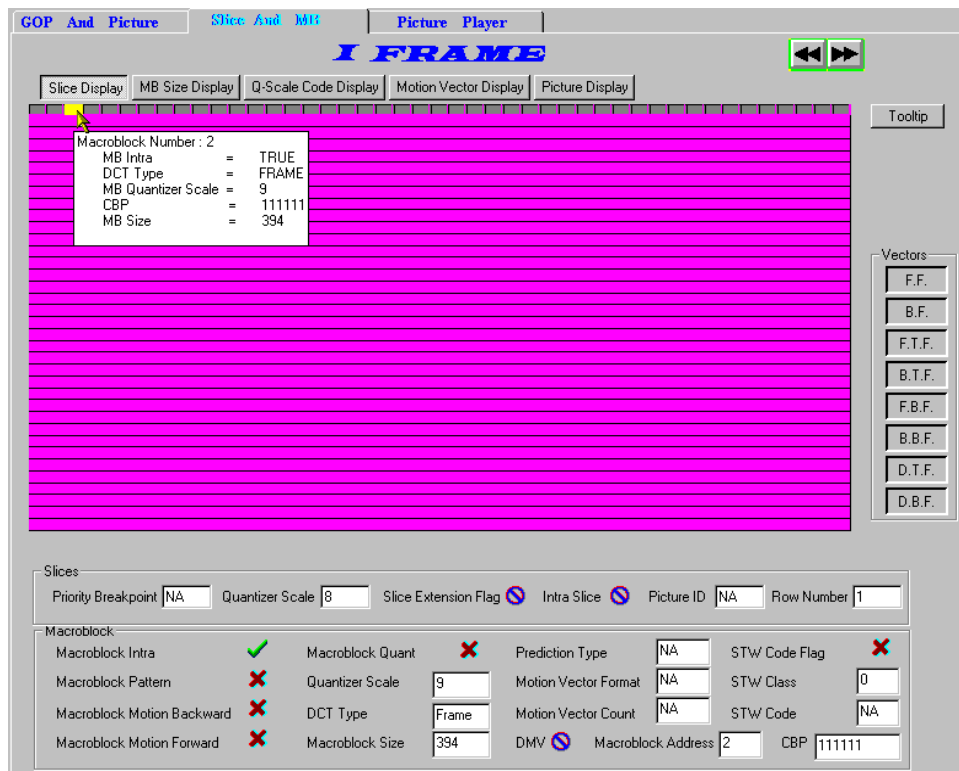

The Slice dialog box graphically displays the slices and macroblocks in the picture and also displays the:

- Slice header for the selected slice.
- Macroblock details for the selected macroblock.
- Picture Quality data, which overlaps the slice display area.
- Decoded field/frame for the selected picture.

### Explaining the Slice and Macroblock Display

When displaying the slices, the current picture is represented by its constituent slices; see the above illustration. You can move the mouse to any slice and select it using the left mouse-button. The slice header display shows the header for the currently selected slice. MPEG-1 slices can span multiple rows and the display shows the same.

Slice display is color coded. Intra-slices are shown in green color, while slices that do not have this flag set are displayed in gray color.

Within a slice, the macroblocks are also shown. You can select a macroblock in the slice using the left mouse-button. The header and information of the currently selected macroblock is displayed below the macroblock display. Skipped macroblocks in a slice are shown using a different color and cannot be selected.

When viewing the slice display, you can move forward to the next picture or backward to the previous picture. You do this by clicking the picture navigation buttons on the top right corner of the dialog box. You can also return to the GOP display and select a specific picture. When moving backwards, you cannot cross the GOP boundary; however, when moving forward, you can cross a GOP boundary.

When displaying macroblocks, the status bar looks like this:

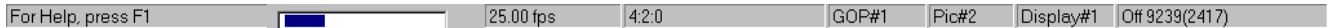

### Viewing Coded Block Patterns for a Macroblock

While in the slice and macroblock level display, you can view the coded block pattern for any macroblock (except for the skipped macroblocks). This is displayed in the last field (CBP) as shown below.

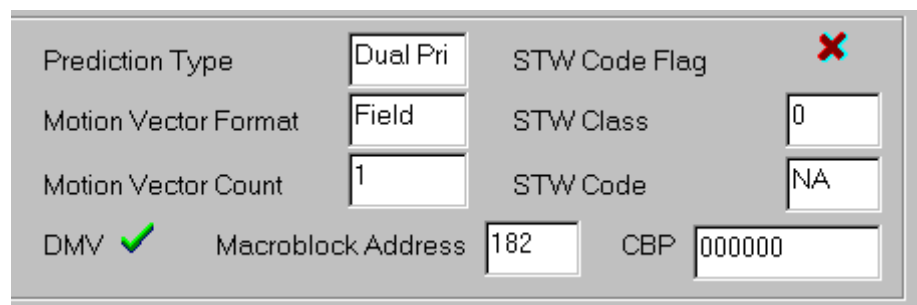

Depending on the chroma format, the coded block pattern is displayed as a sequence of 6, 8, or 12 bits. From left to right, the bit pattern represents the blocks in the macroblock as they are numbered in the standard MPEG specifications. For more details, see the ISO/IEC 11172-3 and ISO/IEC 11318-3 documents.

## Analyzing Picture Quality

### Viewing the Macroblock Size Spectrum

The Macroblock Size Display provides a color-mapped two-dimensional graphical plot of the macroblock size and type distribution in a picture; it is plotted as an overlay on the slice display area. This plot can be viewed by clicking on the MB Size Display button in the Slice and MB tab. The types of all macroblocks in the picture are color-mapped; a key is shown at the right side of the display and described below (see Macroblock Colors). Skipped macroblocks are displayed in dark green. The macroblock size for the selected macroblock is displayed in the macroblock field display area below it.

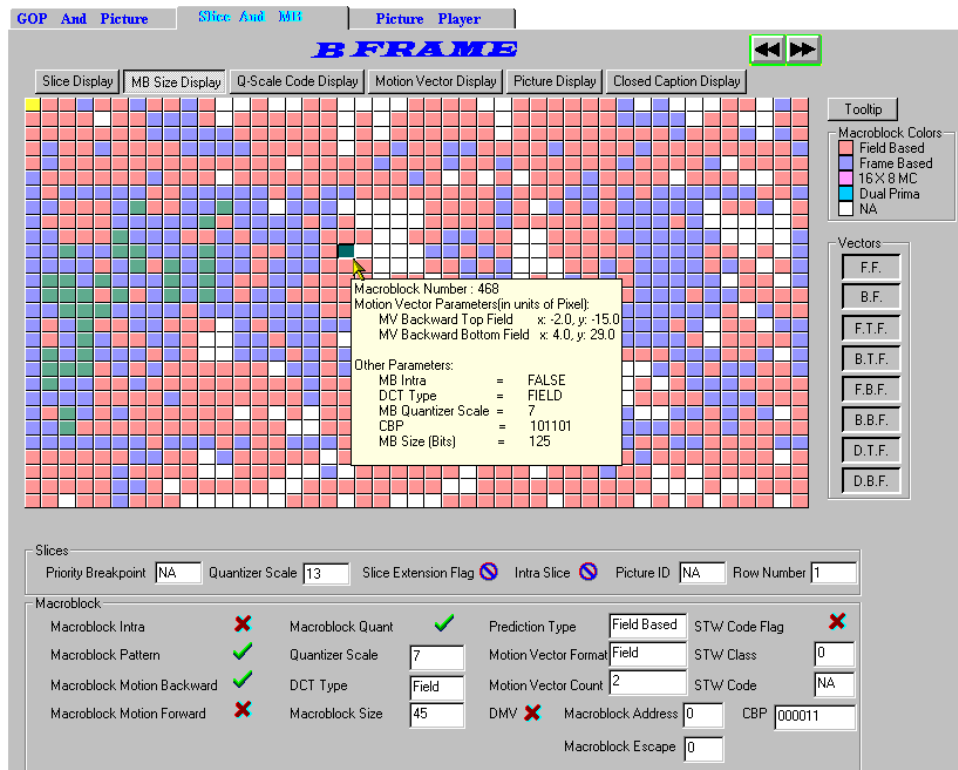

**Macroblock Colors.** The color-coded macroblock type represents the prediction type employed.

- Field Based** Predictions are made independently for each field by using data from one or more previously decoded fields.
- Frame Based** Predictions are made for the frame using the data from one or more previously decoded frames.

16 x 8 MC	(16 x 8 motion compensation) In which two motion vectors are used for each macroblock. The first motion vector is used for the upper 16x8 region, the second for the lower 16x8 region. In the case of a bi-directionally predicted macroblock a total of four motion vectors will be used since there will be two for forward prediction and two for the backward prediction. 16x8 MC is only used with field pictures.
Dual Prima	Only one motion vector is encoded (in its full format) in the bit stream together with a small differential motion vector. In the case of field pictures, two motion vectors are then derived from this information. These are used to form prediction from two reference fields (one top, one bottom) which are averaged to form the final prediction. In the case of frame pictures, this process is repeated for the two fields so that a total of four field predictions are made. This mode is only used in P-pictures where there are no B-pictures between the predicted and reference fields or frames.
NA	Not Applicable - Refers to the instances where there is no prediction in the macroblock.

(For more detailed information, refer to *ISO/IEC 13818-2 : 1996, Information Technology - Generic coding of moving pictures and associated audio information, Part 2 Video.*)

### **Viewing the Quantizer Scale Distribution**

Quantizer scale distribution for the macroblocks in a picture is plotted where the picture slice is displayed. This gives you a graphical view of the scale code distribution and lets you visually check any obvious scale code problems. This plot can be viewed by clicking on the Q-Scale Code Display button in the Slices dialog box. The scale codes of 1 through 31 are mapped to shades of green with 1 being mapped to the lightest shade and 31 to the darkest (black). Skipped macroblocks use the same scheme but are mapped in shades of gray. The value of the scale code for the selected macroblock is displayed in the macroblock field display area below it.

### Viewing the Motion Vector Plots

ES Analyzer gives a detailed graphical display of motion vector for the selected B or P picture. Both MPEG-1 and MPEG-2 type vectors are interpreted and displayed.

#### To view motion vectors (applicable to only B or P pictures).

1. Position the cursor to the picture for which you want to see the slice size plot.
2. Move into the slice display.
3. Click the Motion Vector Display button in the slice display dialog box.

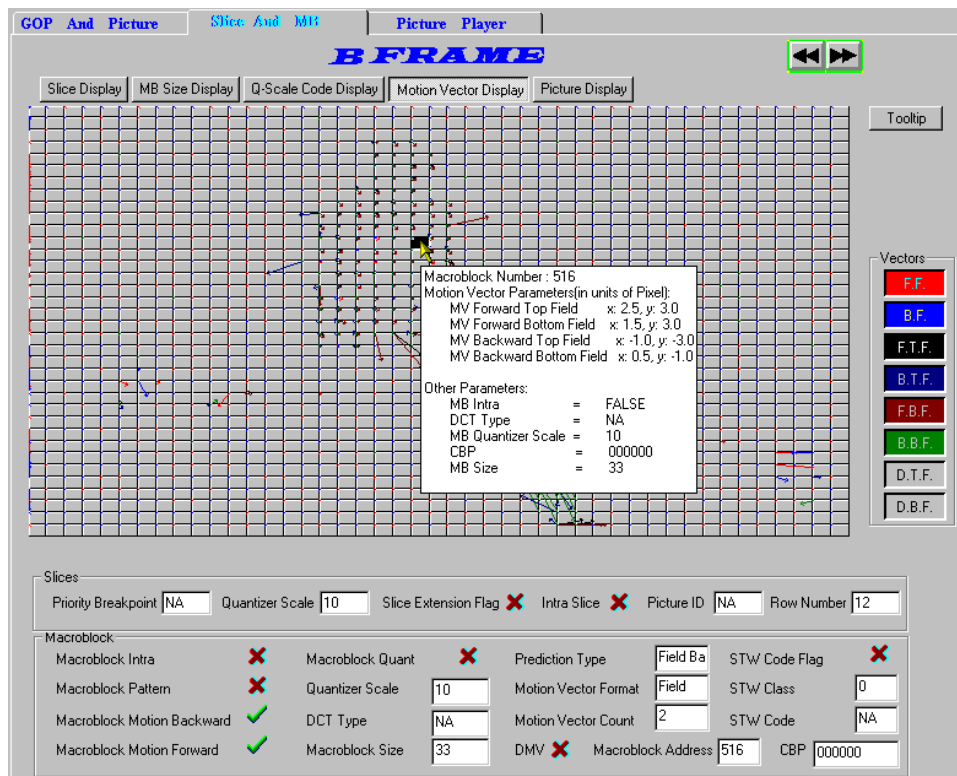

For each macroblock, the motion vectors corresponding to it are plotted to scale as a directed arrow. The direction of the arrow represents motion coding for the macroblock from the reference frame to the current frame. Different types of vectors are plotted in different colors. You can also selectively choose to display different motion vectors by using the buttons on the right.



FF	Forward Frame		BF	Backward Frame
FTF	Forward Top Field		BTF	Backward Top Field
FBF	Forward Bottom Field		BBF	Backward Bottom Field
DTF	DMV Top Field		DBF	DMV Bottom Field

If a button is grayed out, the associated vector is not currently available.

The motion vectors are plotted for the luminance blocks. They are to scale (in the resolution of full pel or half pel) according to the pel resolution fields received. For each macroblock, multiple vectors may be received. All or some of them may be displayed simultaneously.

When Tooltips are enabled, a summary of parameters is displayed in a popup window.

For MPEG-1 that has only frame pictures, two kinds of motion vectors are applicable -forward frame (for P and B pictures) and backward frame (for B pictures).

For MPEG-2 video, additional vectors may also be coded, which are: forward frame (for P and B pictures), backward frame (for B pictures), forward top field, backward top field, forward bottom field, backward bottom field, dual prime top field, dual prime bottom field.

ES Analyzer interprets all the above vectors and lets you view them graphically. When motion vectors cross the picture boundary, an error condition occurs and the same is reported in the error log window. In this case, the vector is drawn until the edge of the picture display.

### Reviewing the Decoded Picture

ES Analyzer decodes and displays the selected picture when you click the Picture Display button. You can view I, B, or P frames or fields (only for MPEG-2).

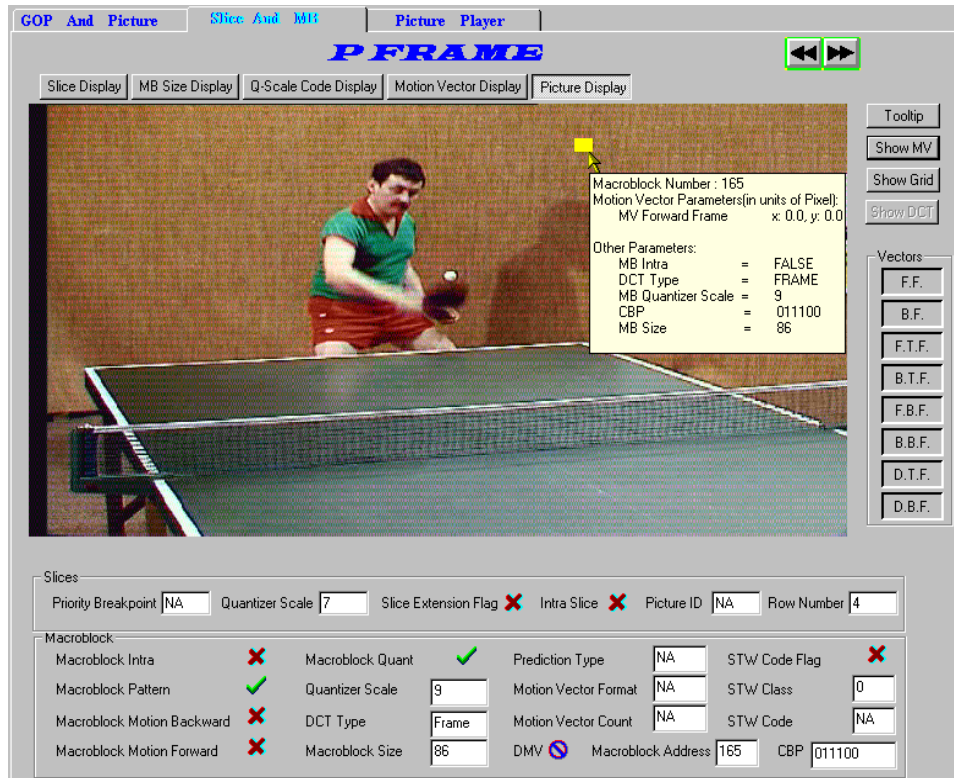

ES Analyzer also allows you to view the previous and the next decoded picture (whether frame or field) by clicking the appropriate buttons. The actual size of the picture is displayed and if the picture is larger than the picture display area, scroll bars will appear. For the current picture being viewed, you can select a macroblock by clicking the left mouse button anywhere in the picture display area. When you do so, the slice and macroblock area below the picture displays the slice and MB data for the currently selected macroblock. If Tooltips are selected, a summary of the macroblock information is displayed in a popup box. When you switch from the picture display to the other picture-quality analysis tabs (e.g., MB Size Display, Q-Scale Code Display or Slice Display), the same macroblock remains selected for easy identification.

You can also enable a macroblock grid on the displayed picture by using the Show Grid button to easily identify and select macroblocks.

The picture display has the following limitations:

- When you navigate to a specific GOP using the toolbar icon, the picture display may be unable to display some B pictures correctly. These pictures are those that use a frame from the previous GOP for reference. This happens only when you navigate to a GOP that is not a closed GOP.
- For MPEG-2 scalable streams, you will be able to display pictures only from the base layer. Other extension layer data cannot be displayed using ES Analyzer.
- ES Analyzer currently displays and decodes video streams within the following MPEG-2 profiles:
  - Main Profile @ High Level (MP@HL)
  - Main Profile @ Main Level (MP@ML)
  - 4:2:2 Profile @ Main Level (4:2:2P@ML)

**Viewing the Decoded Picture with Motion Vector Plots.** The decoded picture can be further enhanced with an overlay of motion vector plots. The interpretation of the display corresponds with the description in the previous section - Viewing the Motion Vector Plots.

To view the vector plots for the currently displayed picture:

- Select the Show MV button on the right side of the picture.
- The vectors displayed will depend upon the selections made from the remaining buttons on the right side of the screen.

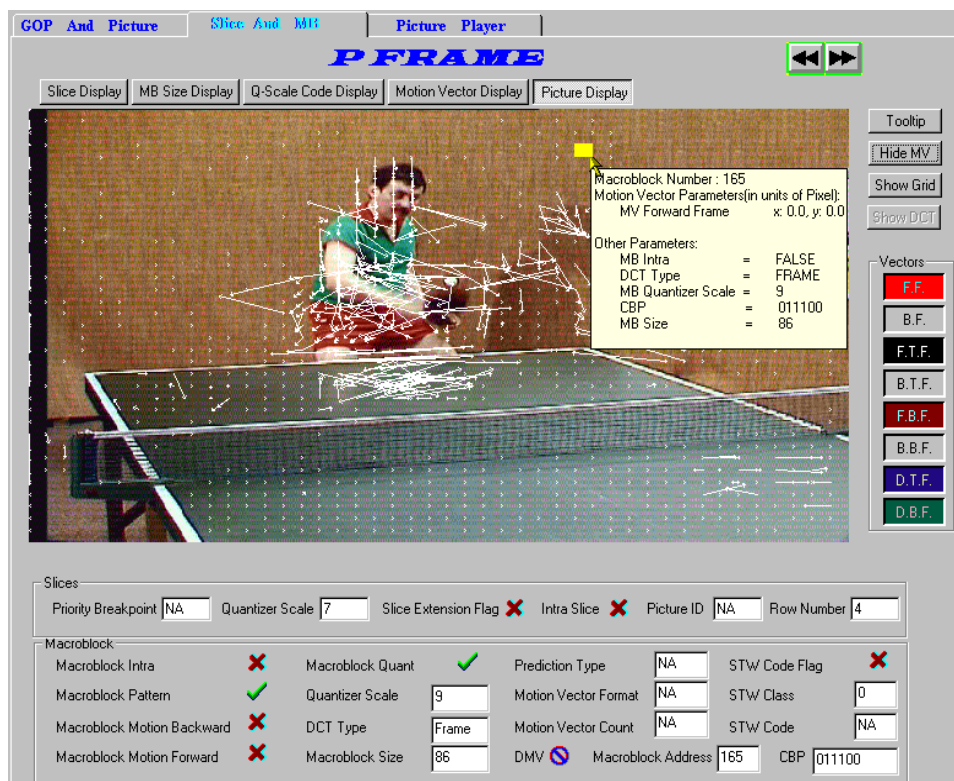

The picture display has the following limitations:

- When navigating to a specific GOP using the toolbar icon, the picture display may be unable to display some B pictures correctly. These pictures are those that use a frame from the previous GOP for reference. This happens only when you navigate to a GOP that is not a closed GOP.
- For MPEG2 scaleable streams, you will be able to display pictures only from the base layer. Other extension layer data cannot be displayed using ES Analyzer.

- For MPEG2 streams, ES Analyzer currently displays and decodes only decodes MP@HL, MP@ML, and 4:2:2 video streams.

**NOTE.** Make sure that your monitor's Display Properties is set to either 24 or 32-bit true color; otherwise, you may find a distortion in the colors in the picture being displayed.

**Displaying DCT Coefficients.** The Discrete Cosine Transformation matrix of each block in a selected macroblock can be seen by selecting Settings > DCT Display from the Menu Bar. The DCT Display option is available only when viewing the details of GOP in Video Stream Analysis. Enabling the DCT Display option will enable Show DCT button next to the displayed picture in Slice & Macroblock Tab, Picture View Mode.

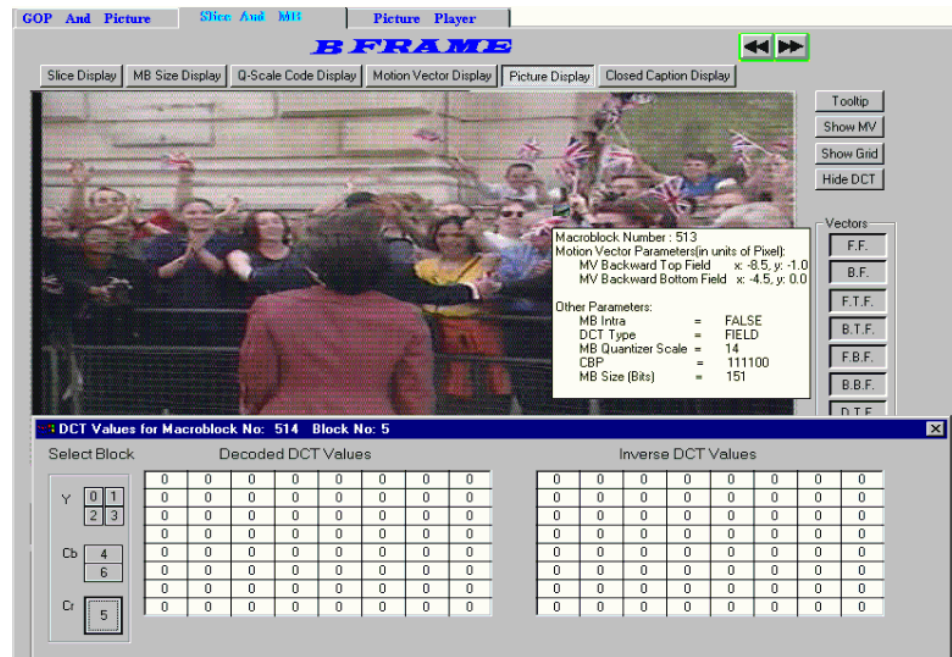

The Show DCT button is used to toggle the DCT Coefficients display. To view the DCT values of the a macroblock, select the macroblock; a window containing details of coded and decoded DCT values will be displayed.

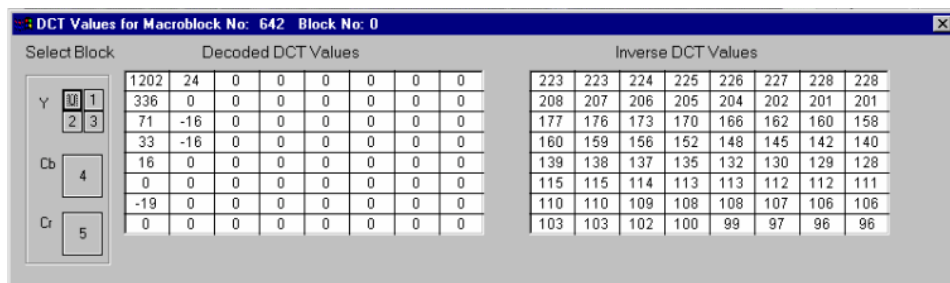

Note that the luma (y) control has four selections (0, 1, 2 and 3) which correspond to an 8x8 pixel corner of the 16x16 pixel selected macroblock. Chroma sub-sampling (Cb and Cr) will display matrices for the color differences between frames.

The picture display has the following limitations:

- When navigating to a specific GOP using the toolbar icon, the picture display may be unable to display some B pictures correctly. These pictures are those that use a frame from the previous GOP for reference. This happens only when you navigate to a GOP that is not a closed GOP.
- For MPEG2 scaleable streams, you will be able to display pictures only from the base layer. Other extension layer data cannot be displayed using ES Analyzer.
- For MPEG2 streams, ES Analyzer currently displays and decodes only decodes MP@HL, MP@ML, and 4:2:2 video streams.

**DCT Value Display - Version Changes.** The diagram below shows the monitoring points in the analysis process for the DCT values. The diagram also indicates the changes that occurred between ES Analyzer, Version 1.5 (MPEG Test System, Versions 6.4 and 6.4.2) and ES Analyzer, Version 1.6 (MPEG Test System, Version 6.5). The “windows” referred to are those in the DCT Values window.

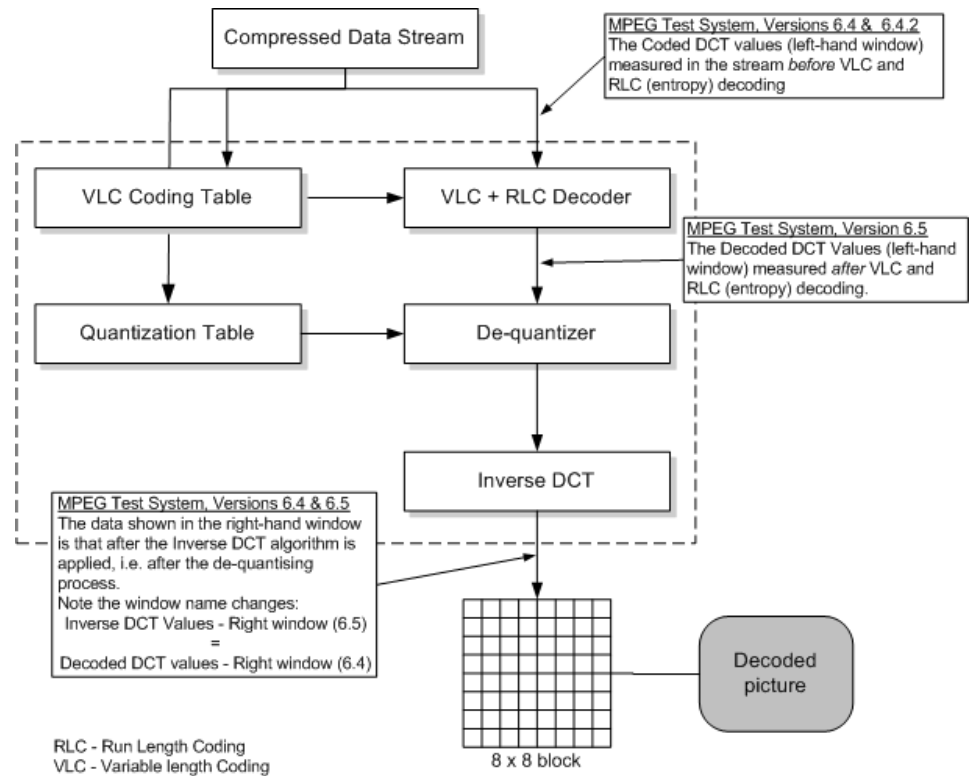

### Configuring Video Analysis Settings

The video analysis or picture analysis default settings can be set as required.

**NOTE.** The selected Video Analysis settings will not affect analysis on either the Slice and Macroblock or the Picture Player pages. On the Slice and Macroblock page, analysis is always at the macroblock level. On the Picture Player page, analysis is always at the picture level.

**Video Analysis Settings.** Select Settings > Video Analysis... from the Menu Bar. The following dialog box is displayed:

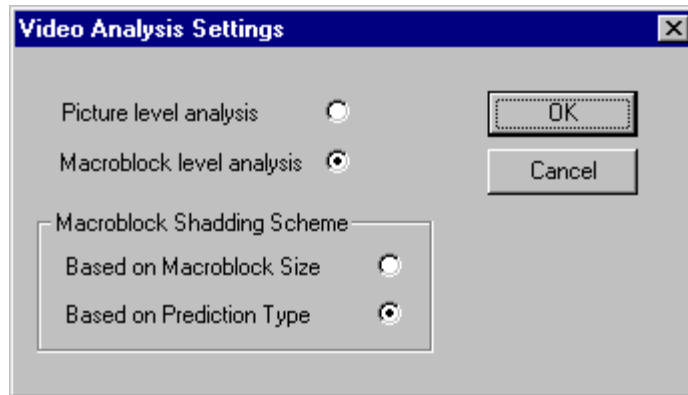

Select Picture level analysis to view frames quickly.

Select Macroblock level analysis if pictures/frames are to be analyzed at the macroblock level.

When Macroblock level analysis is enabled, select the shading scheme required.

**Picture Display Settings.** A number of display and vector parameters are set from the Picture Display Settings dialog.

Select Settings > Picture Display... from the Menu Bar. The following dialog is displayed:

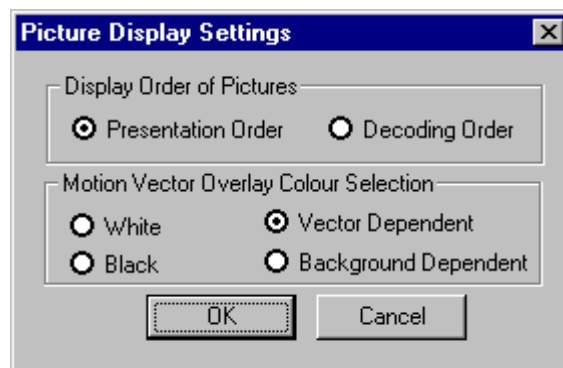





Display Order of Pictures	Select Presentation Order or Decoding order
Motion Vector Overlay Colour Section	<p>White: All vectors will be displayed in white.</p> <p>Black: All vectors will be displayed in black.</p> <p>Vector Dependent: Colors will correspond to the vector selection button colors.</p> <p>Background Dependent: Colors are combined with picture background to provide a contrast.</p>

### Viewing the Slice Size Distribution

For any picture, you can also view the slice size distribution.

#### To view the plot.

1. Position the cursor to the picture for which you want to see the slice size plot on the GOP And Picture tab.
2. Move into the slices display by clicking the Slice and MB tab.
3. Click the Show Slice Size Statistics icon  on the toolbar.

**NOTE.** The Show Slice Size Statistics icon  is grayed out on all tabs except the Slice and MB tab.

The plot appears in another window.

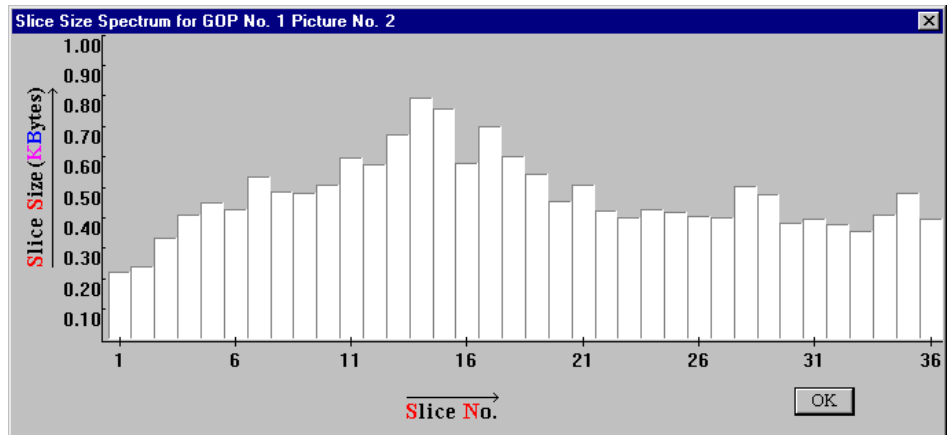

### Viewing the Frame Size Spectrum

You can view the picture spectrum for a GOP and the frame size plots.

#### To view the plot..

1. Display the GOP for which you want to see the Frame Size Spectrum plot.
2. Click the Show Frame Size Statistics icon  on the toolbar.

The following plot is displayed. Each bar represents the frame size in kilobytes:

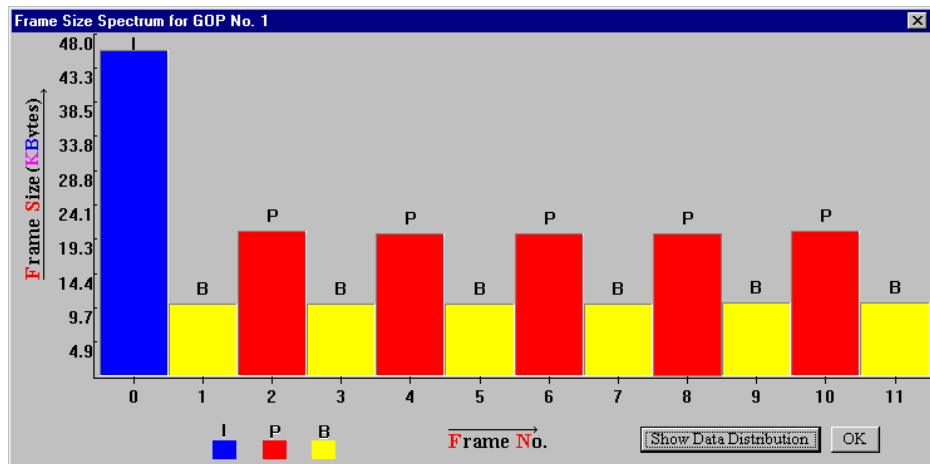

Selecting the Show Data Distribution button will further enhance the plot by showing the content of each frame.

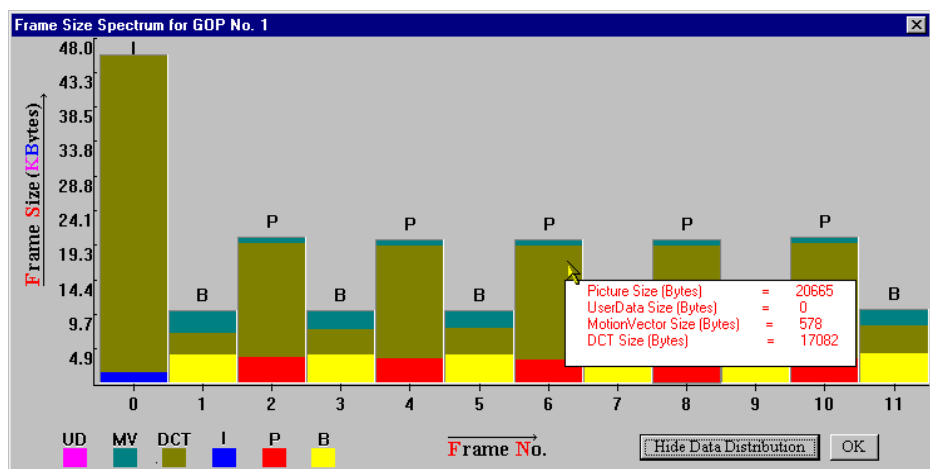

Content is color-coded as shown by the key in the bottom left corner. Details of the content of each frame are displayed when the cursor is moved over a frame.

## Using the Video Viewer for Picture Analysis

The video viewer (or Picture Player) allows you to play a video stream and display the decoded picture on the screen. The picture player playback speed may vary from real time according to the ES Analyzer processor speed. You may also notice certain pauses in the display at regular intervals. These pauses occur at GOP boundaries. The Remote Control (described below) allows you to pause and resume the display at any frame. You can also restart the display from the beginning of the current GOP, or from the start of the video sequence.

The number of the current picture and the number of the last decoded picture are displayed, as shown in the following illustration. Here is a typical sequence of steps in which you may use the video viewer:

1. Open the video stream you want to analyze.
2. Start the video viewer.
3. Monitor the displayed picture for quality problems.



4. Pause the player whenever you notice a problem in a picture, such as a degradation in quality. The player is intentionally made to play at a speed slower than the regular play speed to allow you to stop at specific frames.

5. Switch to the analysis tabs to view details of the currently displayed picture down to the macroblock level.
6. Step forward or backward in decode order in the Slice And MB tab, or switch back to the video viewer and resume play.

ES Analyzer synchronizes the picture being currently displayed by the video viewer with the picture/data that is displayed on the other tabs: GOP And Picture and Slice And MB. This means that:

- The GOP And Picture and Slice And MB tabs always display data for the same picture.
- When you switch from the video viewer to either the GOP And Picture or the Slice And MB tab, you are presented the data for the picture being displayed on the Picture Player tab.
- When you switch from the GOP And Picture or the Slice And MB tab to the Picture Player tab, the video viewer presents the picture for the data being displayed on the GOP And Picture or the Slice And MB tab.
- If you select a macroblock and switch to the picture-quality analysis tabs (such as MB Size Display, Q-Scale Code Display or Slice Display), you will find that the same macroblock remains selected for easy identification.









The video viewer, however, has the following limitations:

- When you navigate to a specific GOP using the toolbar icon, the picture display may be unable to display some B pictures correctly. These pictures are those that use a frame from the previous GOP for reference. This happens only when you navigate to a GOP that is not a closed GOP.
- For MPEG-2 scaleable streams, you will be able to display pictures only from the base layer. Other extension layer data cannot be displayed using ES Analyzer.
- ES Analyzer currently displays and decodes video streams within the following MPEG-2 profiles:
  - Main Profile @ High Level (MP@HL)
  - Main Profile @ Main Level (MP@ML)
  - 4:2:2 Profile @ Main Level (4:2:2P@ML)

**Picture Player Remote Control**

The Remote Control is displayed whenever the Picture Player tab is selected.



	Play Video	Plays the video stream from where it last stopped.
	Stop	Stops the video stream and allows the other analysis tabs to be selected.
	Next Picture	Steps forward one frame.
	Play from GOP Start	Plays the pictures from the start of the current GOP.
	Zoom/Restore Display	Enlarges and restores the area in which the picture appears.
	Fit Best in Display Area/ Display Picture at True Size	Fits picture in display area or displays picture at original size.
	Left/Right Scroll	Scrolls the displayed picture left and right.
	Up/Down Scroll	Scrolls the displayed picture up and down.
	Show/Hide information	Shows or hides the information panel for the displayed picture. The following information is displayed:  <b>GOP Number</b> - in which the frame is present. <b>Coded Number</b> - refers to the picture number within the GOP. <b>Display Time</b> - in hh:mm:ss:cc; where cc is the display number in the whole file. <b>Display Number</b> - refers to the display number of a picture within the GOP.



# Working with Audio Streams

ES Analyzer analyzes both MPEG (-1 and -2) Audio streams and Dolby Digital (AC-3) Audio streams.

## Understanding MPEG Audio Streams

An MPEG audio stream consists of a sequence of audio frames. Audio data may be received for multiple channels. Each channel is divided into sub-bands for which data is transmitted.

ES Analyzer verifies audio streams according to the MPEG audio recommendations. Support for both MPEG Layer I and Layer II audio is available. MPEG-2 extensions for Layer I and II (surround and center channels, and low frequency channels) are also interpreted and analyzed. Multi-lingual extensions in MPEG-2 are currently not analyzed. ES Analyzer is also unable to analyze the MPEG-2 Audio stream if the extension bit stream is present.

For a detailed discussion on the MPEG audio syntax, refer to ISO 11172-3 and ISO 13818-3.

With ES Analyzer, you can:

- Navigate to any audio frame; see details in the Navigating through Streams section in the Getting Started chapter.
- View frame details, including frame header, and plots of the frame data, as shown in the following illustration.
- Interpret and display audio descriptors received in higher level streams and validate them against the stream.
- Play an audio stream.

For each audio frame, data may be received for at most two channels, as shown in the next illustration; additional channels may also be received in the MPEG-2 extension.

## Audio Player

The Audio Player is available on MPEG-1, MPEG-2 and Dolby AC-3 streams (and AAC as an option). With a suitable sound card installed in the host PC, audio streams can be played.

---

**NOTE.** *The speed and quality of playout, is not high fidelity, but is sufficient to allow an audio stream to be monitored for analysis.*

---



---

**WARNING.** *While an audio stream is playing, you cannot access any other analyzer functions. In particular, do not close the Audio Player while an audio stream is playing (especially in loop mode), because you will be unable to reopen the player (and control the stream) until it has finished playing.*

---

If more than one audio device is installed, a selection can be made from the Device drop-down list.



The channels to be played can be selected from the Play Channels drop-down list.







To open the Audio Player, select the player start button, which is available on the audio stream header pages.

The Audio Player control panel is displayed:



The player controls follow the same convention as the Video Player controls:

-  Play
-  Stop
-  Fast forward
-  Fast rewind



(To use Fast Forward and Fast Rewind, press the required button and then stop the action with the Stop button.)

The Audio Player display shows the following:

- Play time
- Stream Name and Audio PID number
- Player status (Stop/Play)

The following controls are available in addition to those described in the preceding list.



Toggles continuous (or looped) payout.



Toggles a real-time waveform display.



---

**NOTE.** Currently two channels are output to the sound card. These can be assigned as required (as mono or stereo) from any of up to five channels in a stream.

---

## Explaining MPEG-1 Audio Streams

ES Analyzer displays data for each channel separately.

The screenshot displays the ES Analyzer interface for an MPEG-1 audio stream. The top section, titled "MPEG 1 Header", shows the following parameters:

MPEG 1 Header			
Frame Header			
ID	1	Layer	Layer2
Bitrate	384kbps	Sampling Frequency	48.0kHz
Private Bit	X	Mode	Stereo
Copyright	X	Emphasis	None
CRC Check	30881	Bound	27
		Protection Bit	X
		Padding Bit	X
		Mode Extension	0
		Original or Copy	X
		SBlimit	27

The bottom section shows analysis data for the "Left Channel". It includes a bar chart titled "Bits/Codeword/sb" (y-axis) versus "sb" (x-axis, 0 to 28). The chart shows a peak at sb=0 and a secondary peak at sb=16. Below the chart are tabs for "Bits/Word", "SCFSI", "Grouping", and "Scalefactor". To the right, the "Channel Select" section shows "Audio Play" controls, "Device" set to "Crystal Audio System Playback", and "Play Channels" set to "Left,Right Channel".

For the selected audio frame, ES Analyzer displays the following:

- The frame header.
- A plot of bits per code word against the sub-bands for each channel.
- SCFSI (Scale Factor Selection Information) plotted against sub-band for each channel.
- Grouping information plotted against sub-bands for each channel.
- The scale factor plotted against the sub-band.
- Channel selection and playout controls.

## Explaining MPEG-2 Audio Streams

For MPEG-2 Audio streams, ES Analyzer analyzes the following channels if the data is present: Left, Right, Left Surround, Right Surround, Center and LFE. Currently, ES Analyzer analyzes 5.1 Audio streams. When ES Analyzer detects an MPEG-2 Audio stream, the information displayed is similar to what is shown in the following illustration.

The screenshot displays the ES Analyzer interface for analyzing an MPEG-2 Audio stream. The top section shows the MPEG-1 Header, MC Header, and MC Composite Status tabs. The MPEG-1 Header tab is active, showing the following fields:

Frame Header			
ID	1	Layer	Layer2
Bitrate	384kbps	Sampling Frequency	44.1kHz
Private Bit	✗	Mode	Stereo
Copyright	✗	Emphasis	None
CRC Check	42153	Bound	30
Protection Bit	✗	Padding Bit	✓
Mode Extension	0	Original or Copy	✓
SBlimit	30		

Below the MPEG-1 Header, there are tabs for Bits/Word, SCFSI, Grouping, and Scalefactor. The Bits/Word tab is active, showing a graph of the Center Channel. The y-axis is labeled Bits/Codeword[sb] and ranges from 0 to 16. The x-axis is labeled sb and ranges from 0 to 28. The graph shows a series of green bars representing the data for the Center Channel.

To the right of the graph, there is a Channel Select section. It includes an Audio Play button, a Device dropdown menu (Crystal Audio System Playback), and a Play Channels dropdown menu (Left,Right Channel). Below this, there are icons for the audio channels: L (Left), R (Right), LS (Left Surround), and RS (Right Surround).

ES Analyzer displays information on the following tabs: MPEG-1 Header, MC Header (Multi-channel header), and MC Composite Status (Multi-channel composite status).

MPEG-2 Audio streams are backward compatible with MPEG-1 streams. Therefore, the MPEG-1 header for each frame is the same as that for an MPEG-2 Audio stream.

The MC Header tab displays information about the additional data present for the multi-channel extensions, over the two stereo channels. It gives you the number of channels that are present, the presence of the LFE channel, additional CRCs, and other relevant fields in the MC Header, as shown.

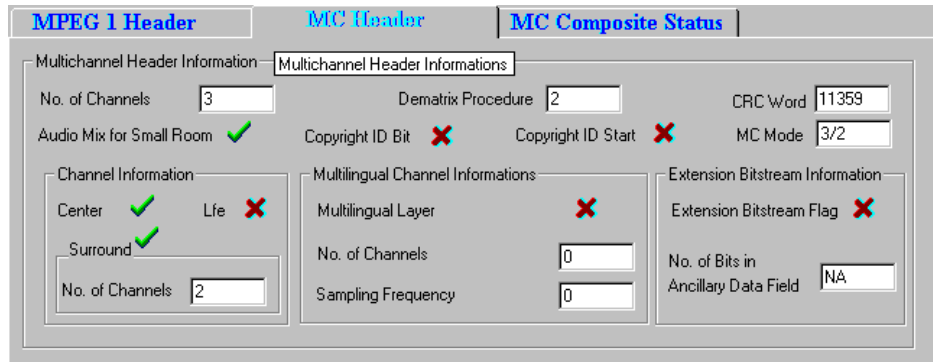

The MC Composite Status tab provides the sub-band information of the channels; and their relationship with the transmission channels, as shown.

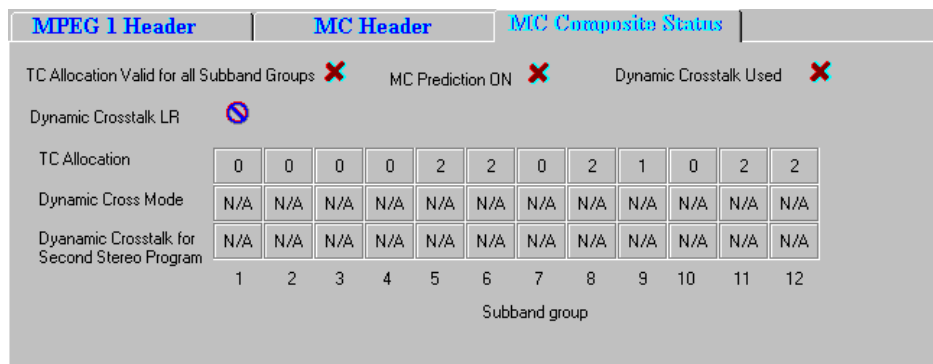

The lower part of the dialog box displays information specific to the channels. You can select the channel for which you want to see the details by clicking the appropriate graphic at right. The channel-specific data for the selected channel is displayed at left as for MPEG-1.

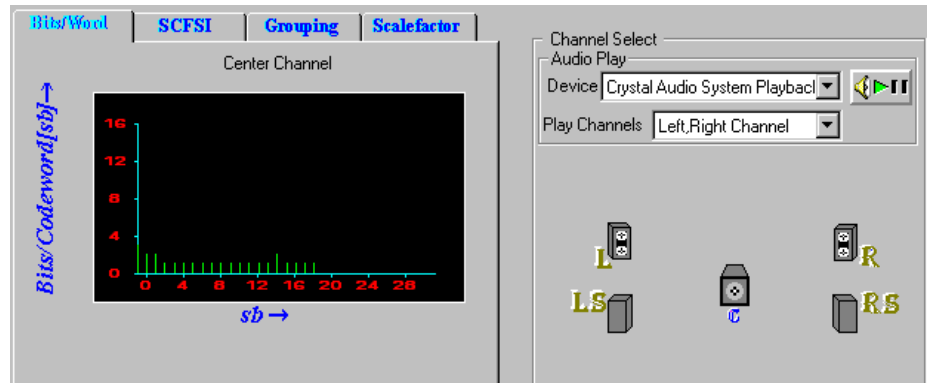

### Explaining the Status Bar Display

The status bar for Audio streams displays the following:

- Frame number, which is the number of the current frame in the stream.
- Layer number, which is the number of the audio stream.
- Byte offset in the file, which is the first byte of the Frame header being currently viewed in both the hexadecimal and decimal formats.

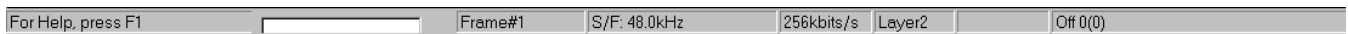

## Understanding Dolby Digital (AC-3) Audio Streams

ES Analyzer also analyzes Dolby Digital’s audio streams, which could be an independent, stand-alone audio stream, or a multiplexed stream that is embedded inside an MPEG-2 System stream (ATSC transport or program stream). The Dolby Digital stream is analyzed by ES Analyzer for syntactic compliance with Dolby Digital specifications.

For a detailed discussion on the Dolby Digital audio syntax, refer to the document A/52 from Advance Television Systems Committee (ATSC).

ES Analyzer analyzes Dolby Digital stream frame by frame and also performs CRC checks for each audio frame. When analyzing a Dolby Digital stream, you may navigate to any frame and also view data specific to an audio block within it.

Automatically detecting the data format used in the Dolby Digital stream, ES Analyzer analyzes both the little endian and the big endian formats. For ease of debugging, ES Analyzer displays information for all the fields of any block for any audio frame.

When errors are encountered in a stream, ES Analyzer reports the errors and synchronizes to the next audio frame to continue the analysis.

ES Analyzer displays the header and audio block information on specific tabs, as shown. The Header And BSI tab displays the Dolby Digital synchronization and bit stream information.

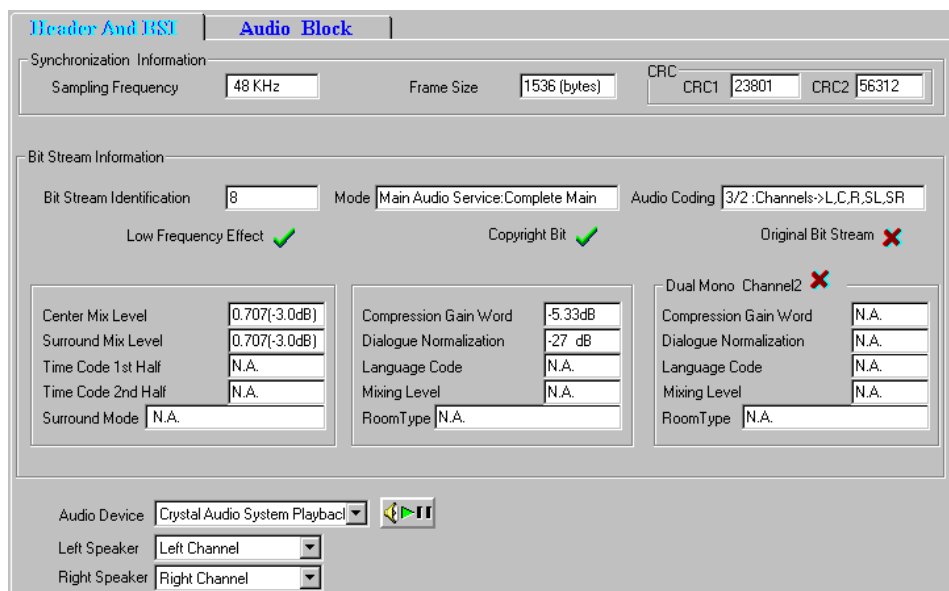

The audio controls are only available on the Header and BSI tab.

Depending on the selection, the Audio Block tab displays information for the corresponding audio block within the frame.

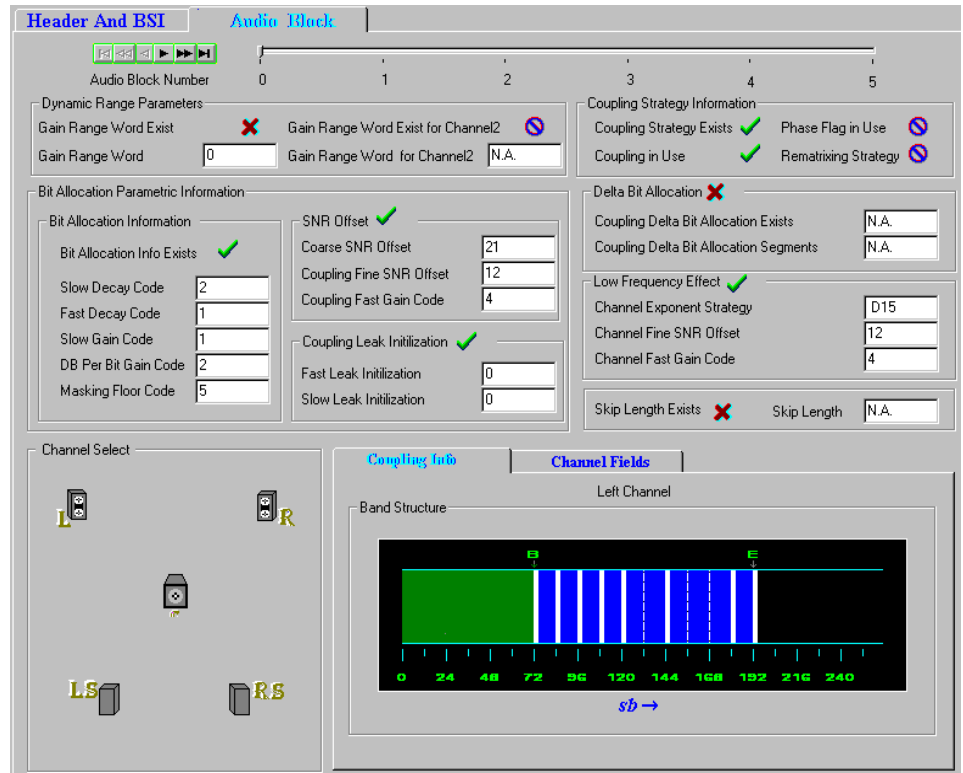

The lower part of the previous illustration displays the channel-specific information for the selected audio block, as shown in the following illustration.

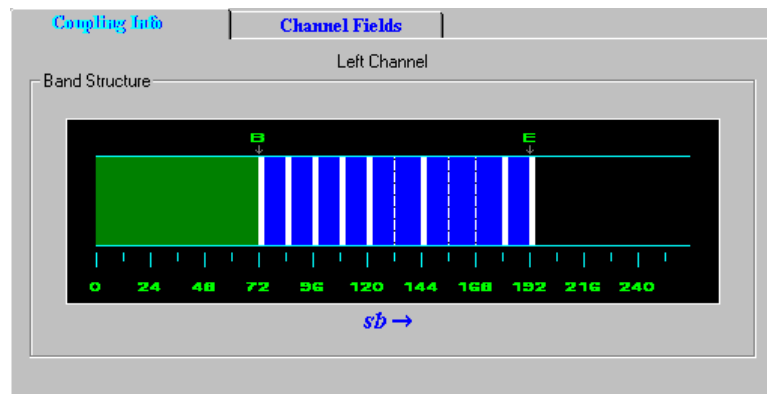

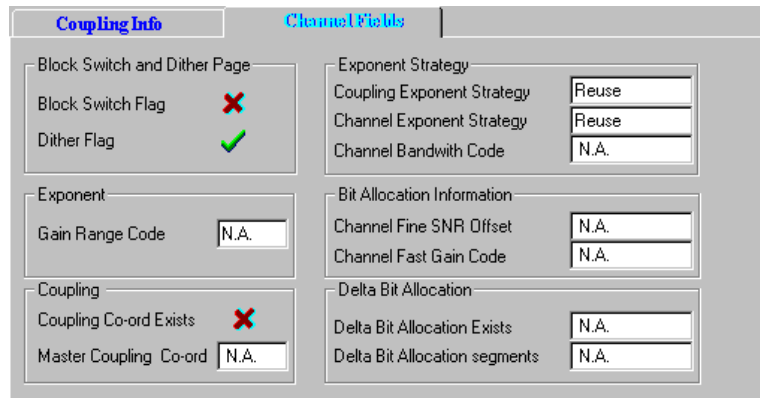

The Coupling information tab distinguishes between the stand-alone and coupled data for the selected channel. The green band denotes the stand-alone information, and the blue region denotes the coupled information. The blue region may be further divided into bands; these appear as solid lines as opposed to the dotted lines that denote sub-bands.

### Explaining the Status Bar Display

The status bar for Dolby Digital Audio streams displays the following:

- Frame number, which is the number of the current frame in the stream.
- Bit rate of the Dolby Digital audio stream.
- Sampling rate.
- Frame size information.
- Byte offset in the file, which is the first byte of the Frame header being currently viewed in both the hexadecimal and decimal formats.





# Working with Program Streams

Program streams are quite similar to MPEG1 System streams in structure. A Program stream consists of a sequence of packs. Each pack has a header, an optional system header, and any number of packets. If a system header is not received in a pack, then the last received header is applicable for the pack. The system header is sent periodically in the stream to facilitate random access. Each pack contains any number of packets. Each packet belongs to a particular stream and has a PID associated with it. If packets of a given PID are concatenated, you get the embedded PES stream with this PID. The PES stream in turn has an elementary stream embedded in it.

For more details on Program streams, refer to the ISO/IEC 13818-1 document.

STREAM ID	STREAM TYPE	STD BUFFER SIZE
192	Audio Stream	4096 Bytes
224	Video Stream	235520 Bytes

ES Analyzer performs conformance and semantic checks at the program stream packet level as per the ISO/IEC 13818-1 recommendations. An embedded stream is checked when you navigate through one; for details, see the Navigating through Streams section in the Getting Started chapter.

For Program streams, you can:

- View pack and system headers, as shown in the previous illustration.
- View the program stream map; see the *Viewing Program Map* section for details.
- View an embedded stream at the PES or the elementary stream level; see the *Understanding Packetized Elementary Streams* section for details.
- Perform buffer analysis of the embedded audio/video stream using the STD model; see the *Analyzing Streams* chapter for details.
- Perform PCR/PTS frequency analysis model; see the *Analyzing Streams* chapter for details.

## Viewing Pack and System Headers

When navigating through a stream, the current pack is displayed in the header display area, as shown in the preceding illustration. The pack and system header fields are displayed for the current packet of the Program stream. The currently applicable system header is displayed for the packet. The receipt of a system header in the current pack is indicated by a check mark in the system header group box. A cross mark indicates that the system header was received earlier.

The list of streams declared in the header is displayed in the elementary stream list box. It is possible that the stream may contain some PES streams that are not declared in the System Header. Such streams are added in the tree view when a packet of the same is encountered.

## Viewing the Program Stream Map

 The program stream map can be viewed by clicking the stream map icon (PSMAP) in the tree view window. This pops up the stream map showing the descriptors for the Program stream and the contained elementary streams. The descriptors associated with each elementary stream in a program can be viewed in one of two ways:

- By double-clicking the corresponding icon for the stream in the display
-  By clicking the more details icon shown for the corresponding stream in the elementary stream listbox

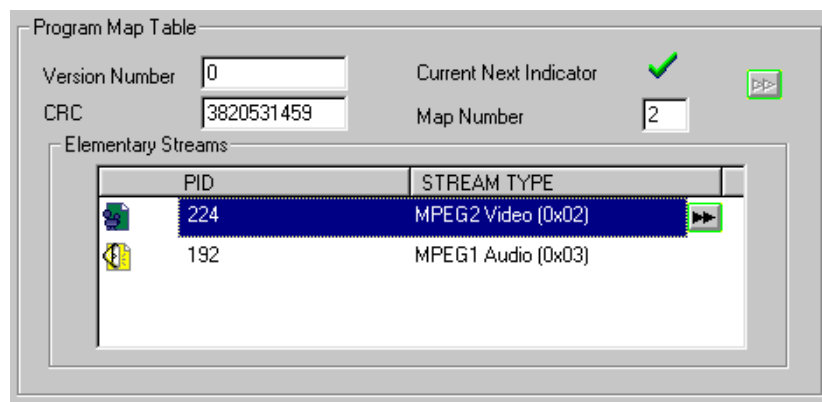

The form is extended (if not already extended) to add the descriptors display, as shown in the following illustrations. All descriptors that are received for the corresponding stream are displayed on tabbed folders. If a descriptor is not received, its tab will not appear in the descriptor display. The illustrations below show descriptors for the respective video and audio tabs.

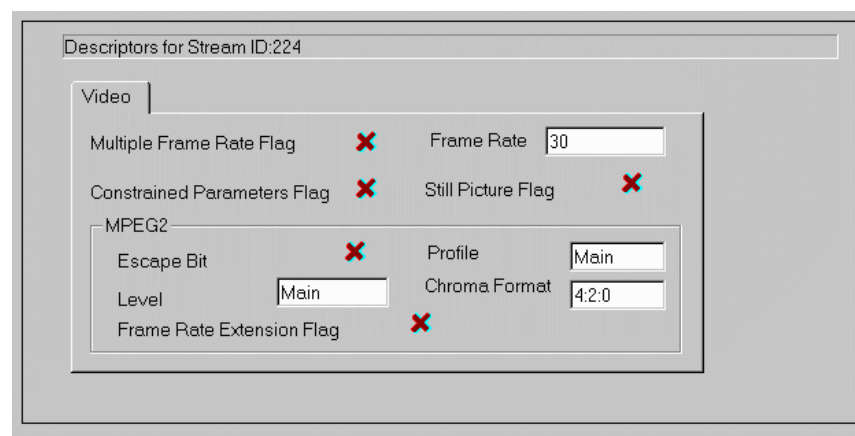

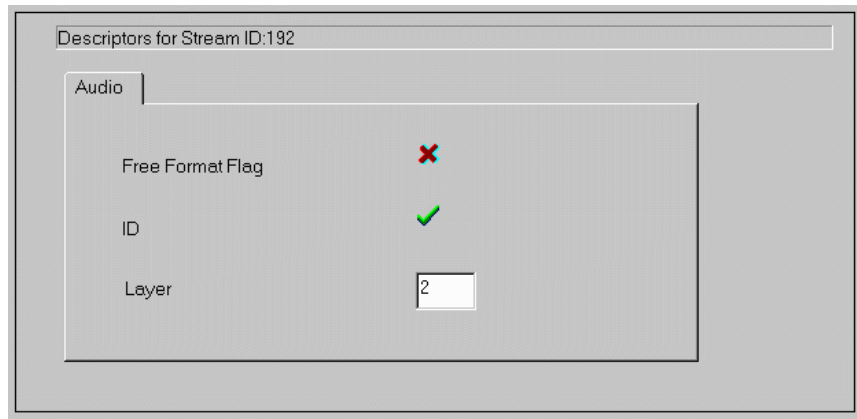

### Explaining the Status Bar Display

The status bar for Program streams displays the following:

- Pack number, which is the number of the displayed packet.
- Packet number, which is the number of the current packet in the entire stream.
- Packet number of SID, which is the number of the current packet taking into account only packets of the same stream ID (SID).
- At GOP level, the location of GOP header/start at PES level and Pack level is displayed by PES packet number & Pack number respectively.
- At AES & AC3 level, the location of frame header/start at PES level and Pack level is displayed by PES packet number and Pack number respectively.
- Byte offset in the file, which is the first byte of the Pack header being currently viewed in both the hexadecimal and decimal formats.

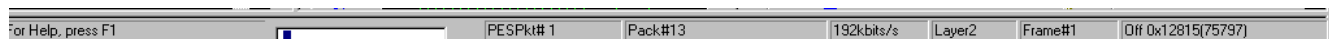

# Working with Teletext

Teletext can be incorporated into DVB streams. ES Analyzer allows the associated data to be analyzed and viewed.



To view the teletext data, navigate to the teletext icon in the Tree View window.

Initially, the Page Header data will be displayed:

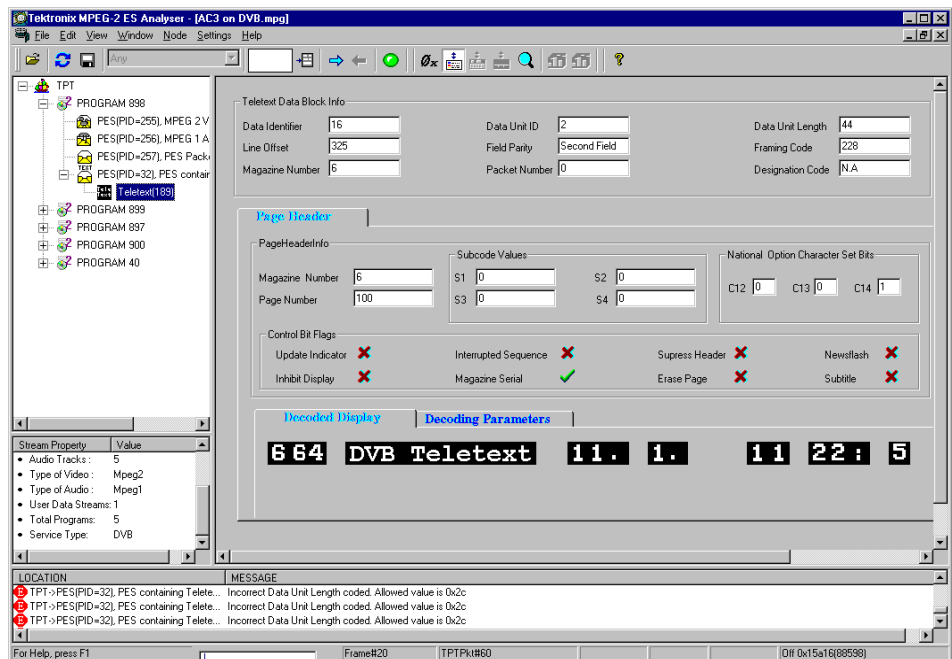

Using the Next button, details of the page can be viewed in the Data Packet tab.

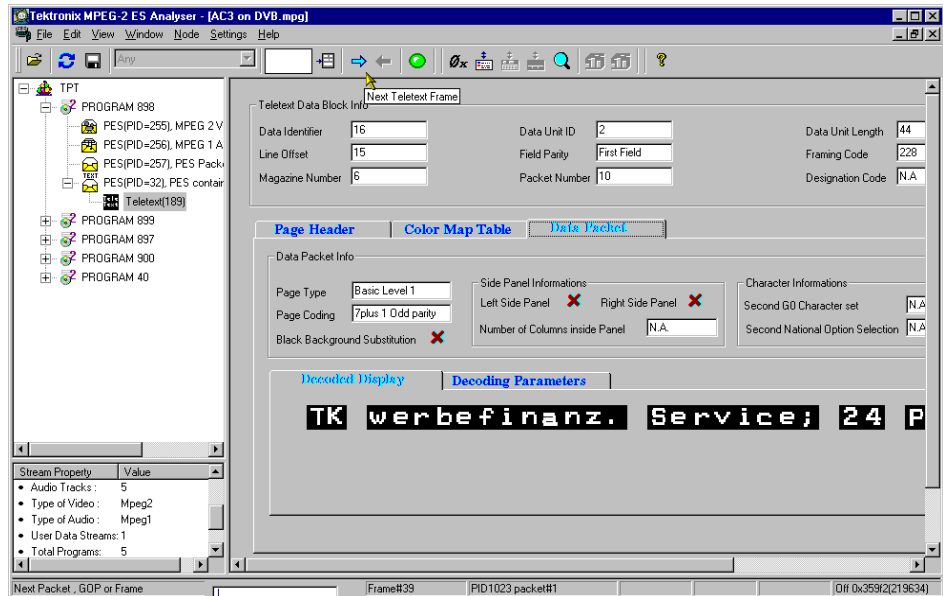

Other tab pages (Color Map Table, Decoded Display, Decoding Parameters) provide detailed teletext encoding data. These tabs will only appear as progress is made through the stream using the Next button and the analyzer detects them.

## VBI (Enhanced Teletext Support)

Enhanced teletext support is available (reference: ETSI EN 301-775). The supported extensions include the following:

- VPS (Video Program System)
- WSS (Wide Screen Signaling)
- Monochrome Data

Note that the associated information screens will only be available for display where data of the specific type is available in the stream.

Examples of the screens are shown in the following illustrations.

**VPS (Video Program System)**

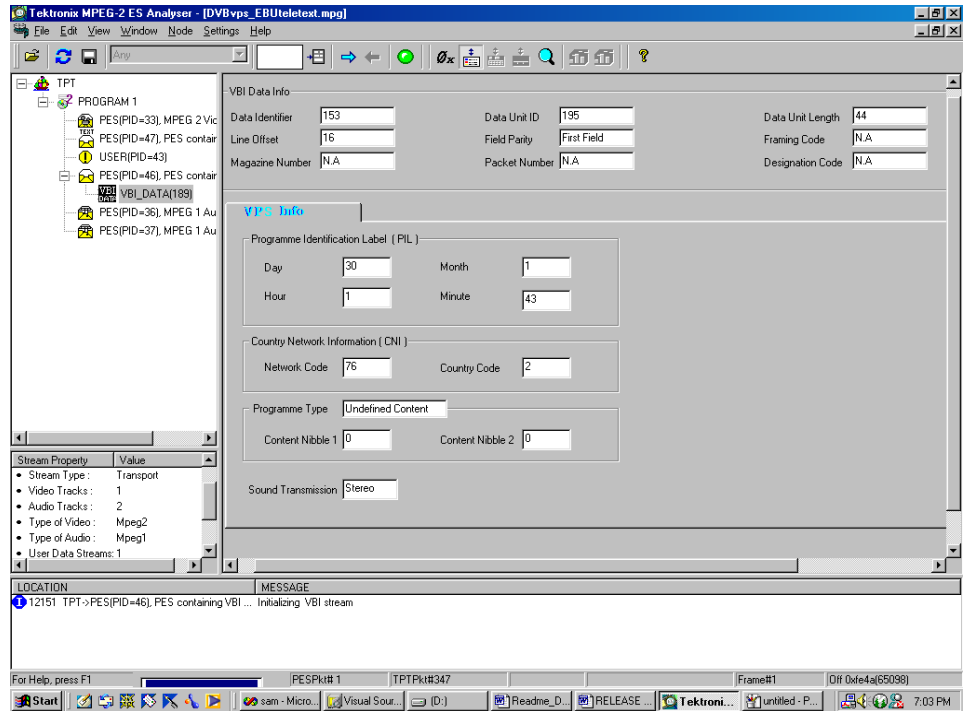

### WSS (Wide Screen Signaling)

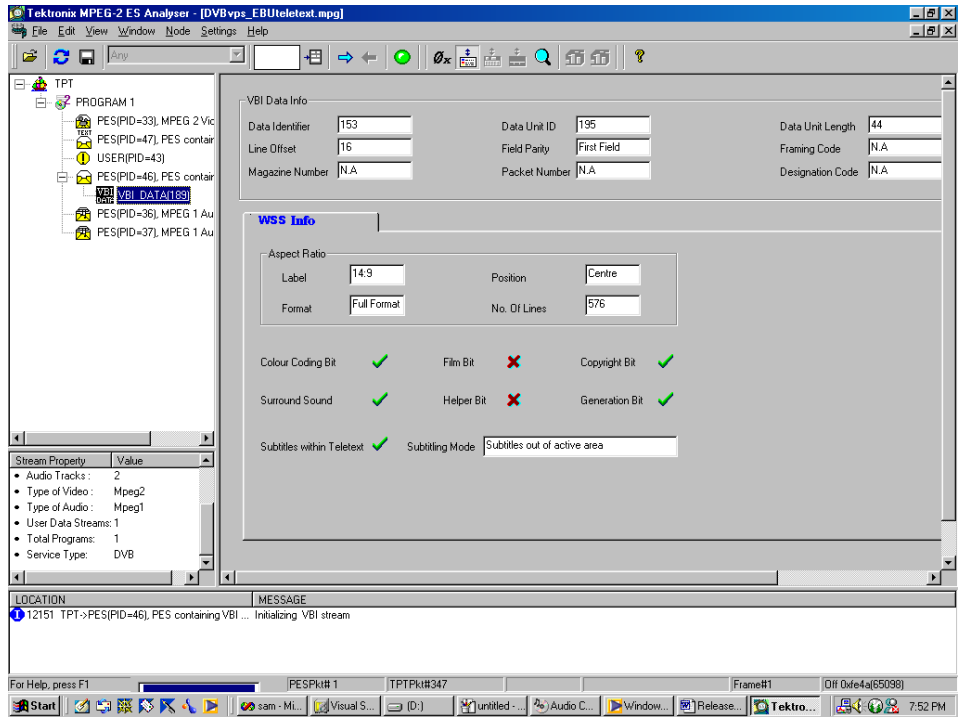

### Monochrome Data

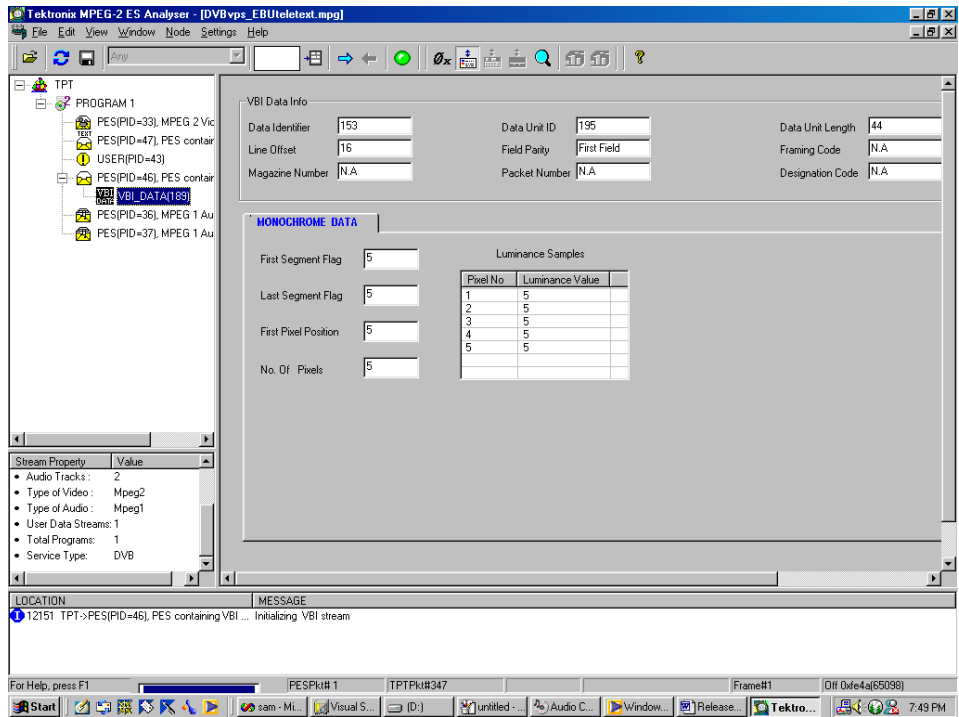



# Advanced Audio Compression

Elementary Stream Analyzer (ES Analyzer) performs off-line stored stream analysis for MPEG1 Audio, MPEG2 Audio, and Dolby Digital Audio streams, as well as MPEG1 and MPEG2 video streams. The streams can be embedded inside DVB, ATSC or MPEG1 System streams.

Advanced Audio Compression (AAC) is one of the audio compression formats defined by the MPEG-2 standard. AAC used to be called NBC (Non-Backward-Compatible), because it is not compatible with the MPEG-1 audio formats. AAC offers a better compression ratio than MP3 (MPEG-1 Layer 3) and is the state-of-the-art in audio compression technology. It can include up to 48 audio channels, 15 low frequency enhancement channels, 15 embedded data streams and has multi-language capability. MPEG formal listening tests have demonstrated that it can provide slightly better audio quality at 96 kb/s than layer-3 at 128 kb/s or layer-2 at 192 kb/s.

Due to its high coding efficiency, AAC is a prime candidate for any digital broadcasting system. The Japanese authorities were the first to decide to use AAC within practically all-digital audio broadcasting schemes. Because their first services will start in the year 2000, this decision has already triggered the development of dedicated AAC decoder chips at a number of manufacturers. Due to its superior performance, AAC will also play a major role for the delivery of high-quality music via the Internet. Furthermore, AAC (with some modifications) is the only high-quality audio-coding scheme used within the MPEG-4 standard.

The AAC bit stream is encoded in either of two formats:

- Audio Data Interchange Format (ADIF)
- Audio Data Transport Stream Frame (ADTS)

The corresponding forms are displayed according to the format of the input bit stream. These forms display the information contained in the fields of the Header and the Raw Data.

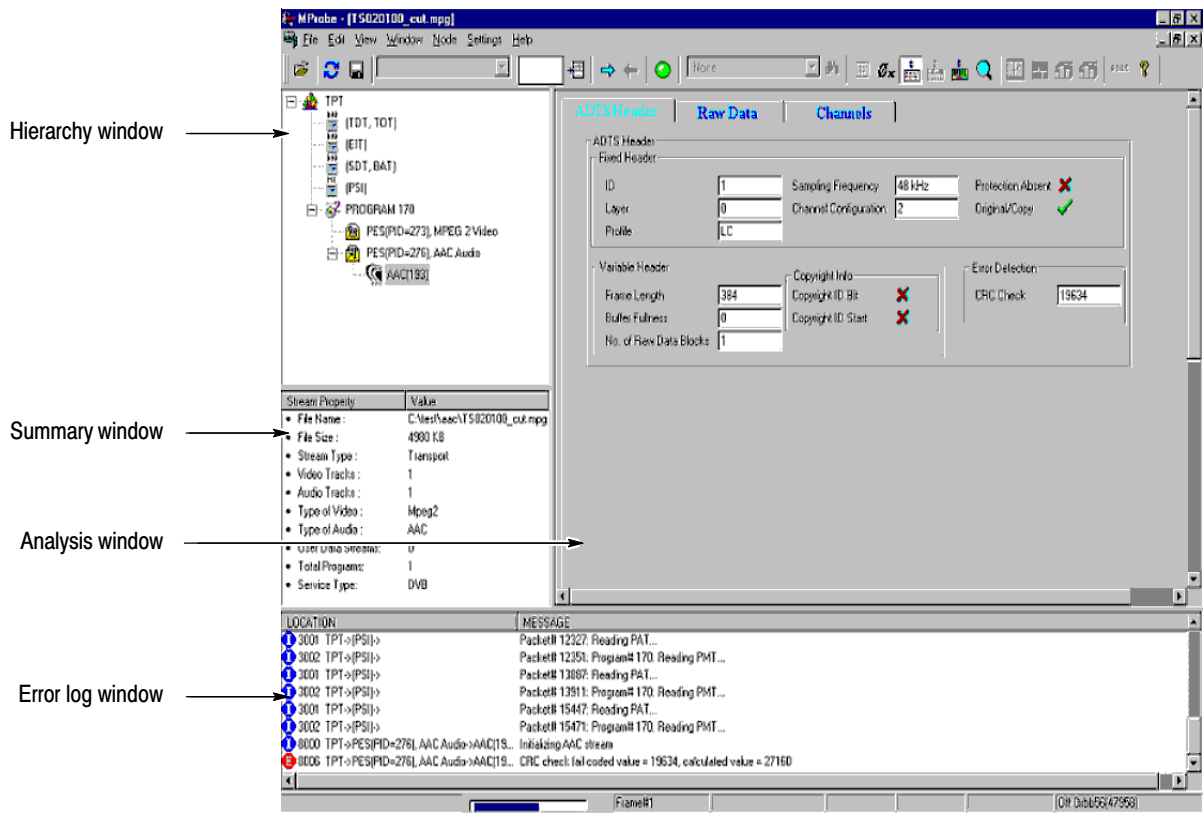

## ADIF Stream Forms

The analyzed information regarding the input ADIF stream is displayed by means of a property sheet containing three tabs.

The 'ADIF Header' tab (Figure 5-1) displays the fields of the header.

The screenshot shows the 'ADIF Header' tab of a software interface. It contains several sections of fields:

- Copyright Info:** Copyright Identifier (N.A.), Copyright ID Present (X), Copyright No. (N.A.), Original/Copy (checkmark), Bitrate (1920 Kbps), Bitstream Type (constant).
- Program Configuration:** No. of Program Configuration Elements (1), PCE No. (slider), Buffer Fullness (294912).
- Program Configuration Element:** Element Instance Tag (0), Profile (LC), Sampling Frequency (8 kHz).
- Channel Configuration:**

No. of Front Ch. Elements	11	SCE 0, SCE 1, SCE 2, SCE 3, SCE 4, SCE 5, SCE 6, CPE 0, CPE 1, CPE 2,
No. of Side Ch. Elements	9	CPE 4, CPE 5, CPE 6, CPE 7, CPE 8, CPE 9, CPE 10, CPE 11, CPE 12,
No. of Back Ch. Elements	12	CPE 13, CPE 14, CPE 15, SCE 7, SCE 8, SCE 9, SCE 10, SCE 11, SCE 12,
No. of LFE Ch. Elements	0	N.A.
No. of Valid CC Elements	0	N.A.
No. of Associated Data Elements	0	
- Mixdown and Matrix:** Mono Mixdown Present (X), Mono Mixdown Element No. (N.A.), Stereo Mixdown Present (X), Stereo Mixdown Element No. (N.A.), Matrix Mixdown Index Present (X), Matrix Mixdown Index (N.A.), Pseudo Surround Enable (disabled).
- Comment Field Length:** 59

**Figure 5-1: ADIF header Information**

The 'Raw Data' tab (Figure 5-2) displays the fields in each raw data block. A slider control helps to navigate through the various raw data blocks. The information regarding each raw data block is displayed by means of another child property sheet containing seven tabs (the fields in each tab are shown in Figure 5-3 to Figure 5-9).

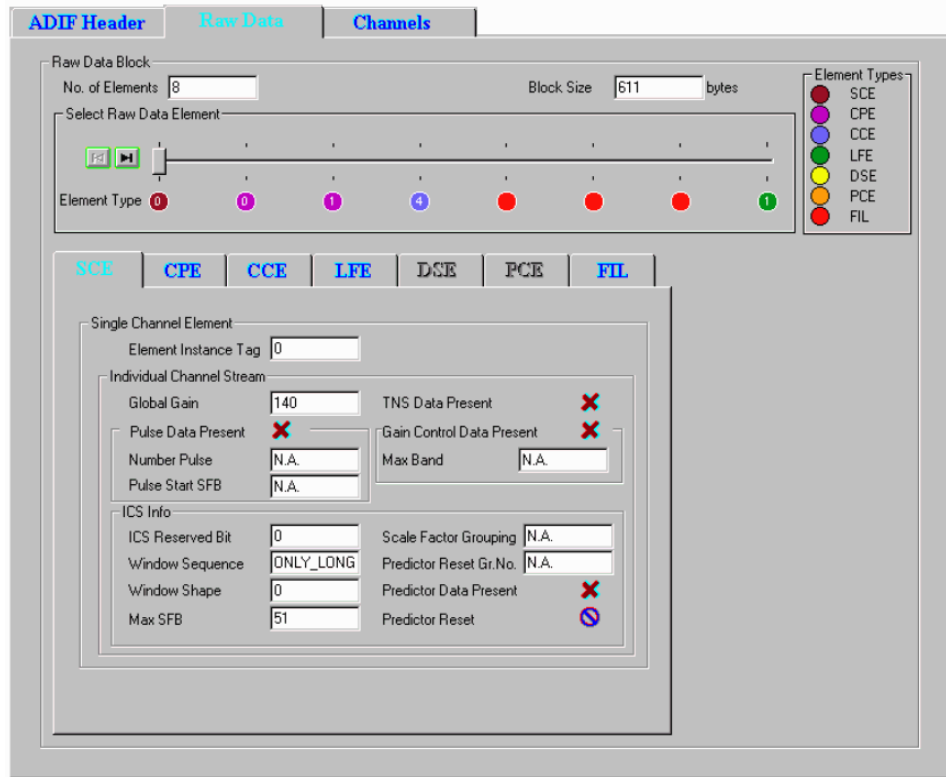

Figure 5-2: ADIF raw data Information

**Element Color Coding in the Raw Data Tab**

The Element Type (below the slider bar) is color-coded; the key is given on the right side of the display in the Element Types box. The number displayed in the Element Type color spot indicates the EIT (element instance tag) of that syntactic element.

**Color Coding of Raw Data Tabs**

The text in the Raw Data tabs is color-coded as follows:

- Light Blue indicates the syntactic element is present and activated in the raw data.
- Dark Blue indicates that the syntactic element is present, but currently inactive in the raw data.
- Dark Gray indicates that the syntactic element is not present in the raw data.

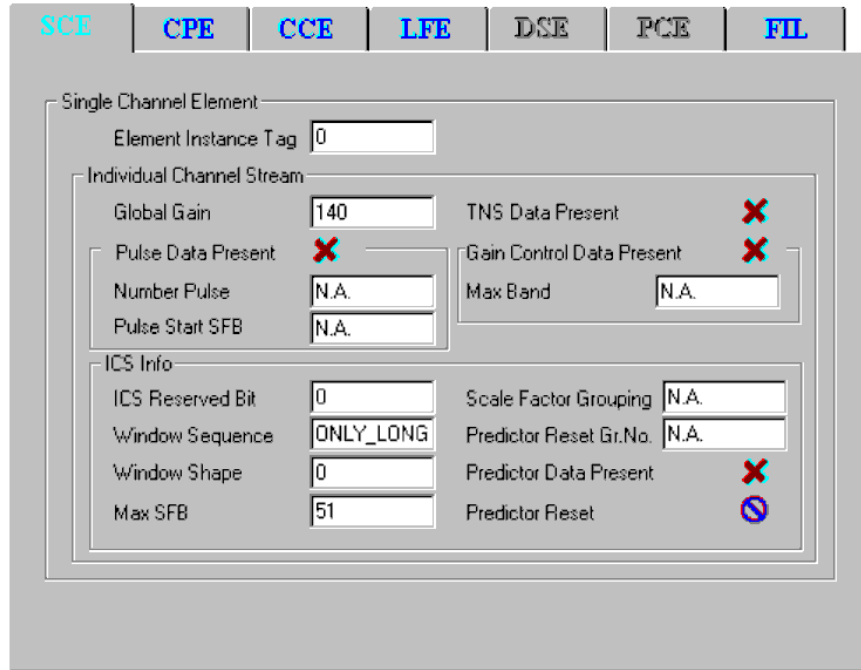

Figure 5-3: Single channel element Information

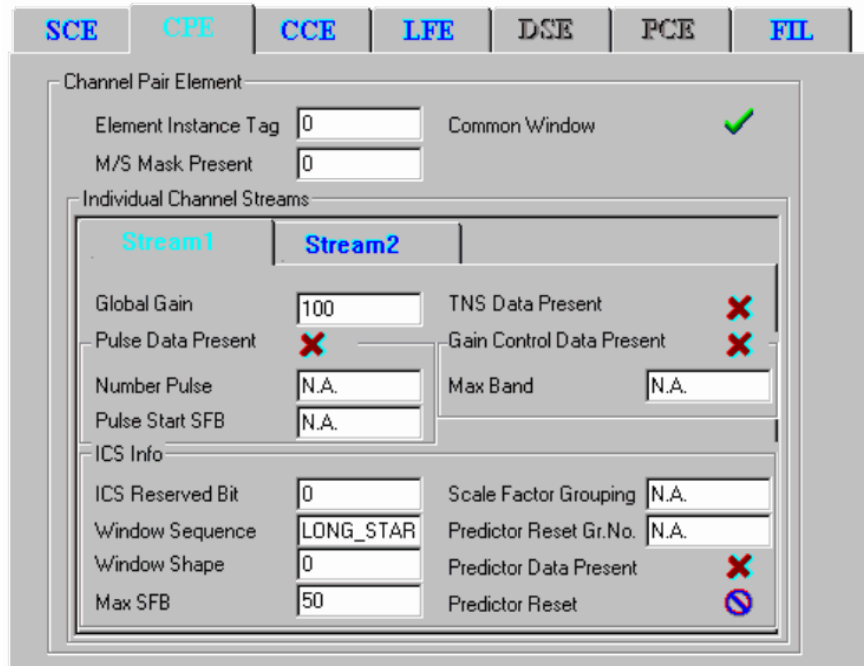

Figure 5-4: Coupling pair element information

SCE	CPE	CCE	LFE	DSE	PCE	FIL
Coupling Channel Element						
Element Instance Tag	4	Independently Switched Flag				✓
No. of Coupled Elements	0	CC Domain				✓
Gain Element Scale	1	Gain Element Sign				✗
Individual Channel Stream						
Global Gain	100	TNS Data Present				✗
Pulse Data Present	✗	Gain Control Data Present				✗
Number Pulse	N.A.	Max Band			N.A.	
Pulse Start SFB	N.A.					
ICS Info						
ICS Reserved Bit	0	Scale Factor Grouping			N.A.	
Window Sequence	ONLY_LONG	Predictor Reset Gr.No.			N.A.	
Window Shape	1	Predictor Data Present				✗
Max SFB	0	Predictor Reset				⊘

Figure 5-5: Coupling channel element information

SCE	CPE	CCE	LFE	DSE	PCE	FIL
LFE Channel Element						
Element Instance Tag	0					
Individual Channel Stream						
Global Gain	100	TNS Data Present				✗
Pulse Data Present	✗	Gain Control Data Present				✗
Number Pulse	N.A.	Max Band			N.A.	
Pulse Start SFB	N.A.					
ICS Info						
ICS Reserved Bit	0	Scale Factor Grouping			N.A.	
Window Sequence	ONLY_LONG	Predictor Reset Gr.No.			N.A.	
Window Shape	0	Predictor Data Present				✗
Max SFB	4	Predictor Reset				⊘

Figure 5-6: Low frequency element channel information

SCE	CPE	CCE	LFE	DSE	PCE	FIL
Data Stream Element						
Element Instance Tag		15		Count		2
Data Byte Align Flag		✓		Increment Count		7747784141

Figure 5-7: Data stream element information

SCE	CPE	CCE	LFE	DSE	PCE	FIL
Program Configuration Element						
Element Instance Tag		0		Profile		1
				Sampling Freq.		48 kHz
Channel Configuration						
No. of Front Ch. Elements		2		SCE 0, CPE 0,		
No. of Side Ch. Elements		0		N.A.		
No. of Back Ch. Elements		1		CPE 1,		
No. of LFE Ch. Elements		1		LFE 0,		
No. of Valid CC Elements		0		N.A.		
No. of Assoc. Data Elements		0				
Mono Mixdown Present		✗		Stereo Mixdown Present		
Mono Mixdown Element No.		N.A.		Stereo Mixdown Element No.		
				N.A.		
Matrix Mixdown Index Present		✗		Comment Field Length		
Matrix Mixdown Index		N.A.		0		
				Pseudo Surround Enable		
				⊘		

Figure 5-8: Program configuration element information

SCE	CPE	CCE	LFE	DSE	PCE	FIL
-----	-----	-----	-----	-----	-----	-----

Fill Element

Count	<input type="text" value="0"/>	Increment Count	<input type="text" value="255"/>
Extension Payload			
Extension Type	<input type="text" value="Bitstream filler"/>		

**Figure 5-9: Fill element information**



The ‘Channels’ tab (Figure 5–10) displays the configuration of the coded channels. The physical location of the speakers corresponding to the channels coded in the stream for standard and non-standard configurations can be displayed.

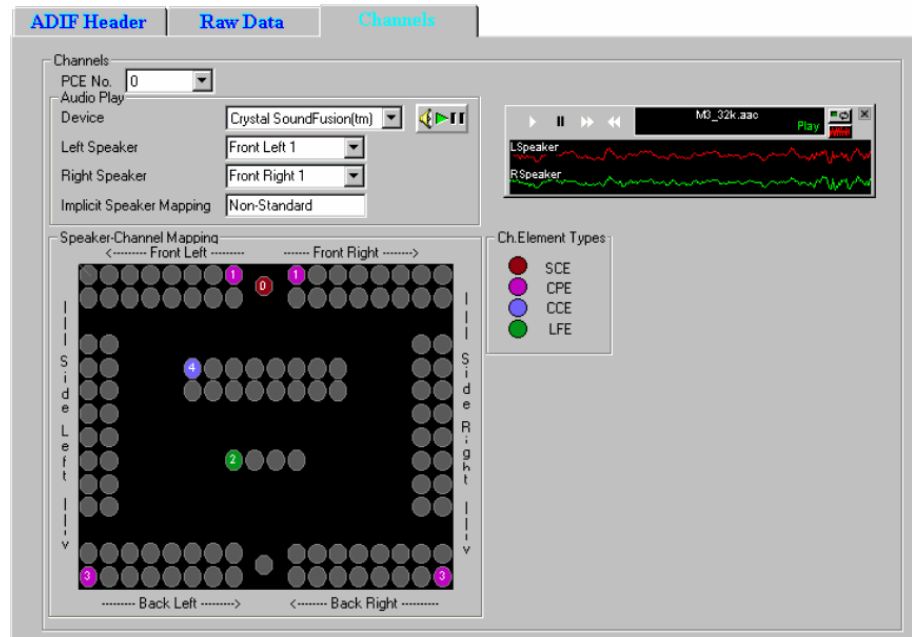

Figure 5–10: ADIF channels (non-standard) information

The syntactic element type corresponding to each speaker in the Speaker-Channel Mapping is denoted by a color-code scheme, the legend for which is given in the Ch.Element Types box. The number appearing in the color spots denotes the EIT (element instance tag) of that syntactic element.

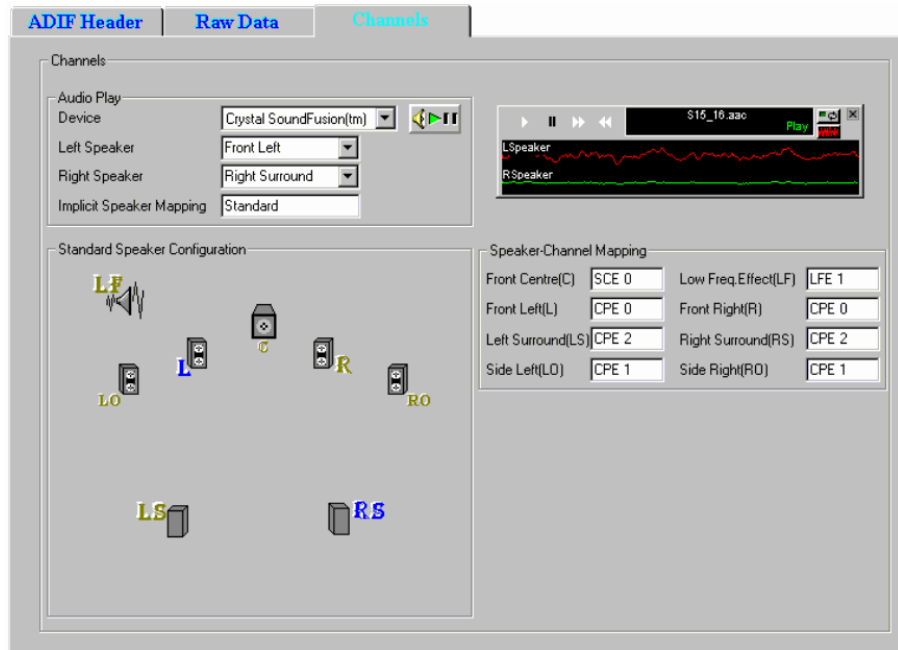

Figure 5-11: ADIF channels (standard) information

## ADTS Stream Forms

The analyzed information regarding the input ADTS stream is displayed by means of a property sheet containing three tabs.

The 'ADTS Header' tab (Figure 5–12) displays the fields of the header, while the 'Raw Data' tab displays the fields in each raw data block and the 'Channels' tab displays the configuration of the coded channels. The content of the 'Raw Data' and 'Channels' tabs are identical to that in the ADIF stream.

The screenshot shows a software interface with three tabs: 'ADTS Header' (selected), 'Raw Data', and 'Channels'. The 'ADTS Header' tab is divided into three sections: 'Fixed Header', 'Variable Header', and 'Error Detection'. The 'Fixed Header' section contains fields for ID (1), Layer (0), Profile (SSR), Sampling Frequency (12 kHz), Channel Configuration (1), Protection Absent (marked with a red X), and Original/Copy (marked with a red X). The 'Variable Header' section contains fields for Frame Length (358), Buffer Fullness (85), No. of Raw Data Blocks (1), Copyright Info (with Copyright ID Bit and Copyright ID Start both marked with red Xs). The 'Error Detection' section contains a CRC Check field with the value 63050.

Section	Field	Value	Status
Fixed Header	ID	1	
	Layer	0	
	Profile	SSR	
	Sampling Frequency	12 kHz	
	Channel Configuration	1	
	Protection Absent		✗
Variable Header	Frame Length	358	
	Buffer Fullness	85	
	No. of Raw Data Blocks	1	
	Copyright ID Bit		✗
	Copyright ID Start		✗
Error Detection	CRC Check	63050	

Figure 5–12: ADTS header information



# Closed Caption Analysis

Closed captions are captions that are hidden in the video signal, invisible without a special decoder. The place they are hidden is called line 21 of the vertical blanking interval (VBI).

ES Analyzer allows closed caption data to be analyzed and inspected.

The two options are:

- CCA Standalone (Player + CC-EIA608 + CC-EI708 analysis)
- Full Elementary Stream Analyzer + CC-EIA608 + CC-EI708 analysis

---

**NOTE.** *No special installation process is required. The options are dongle protected/enabled.*

---

The Stand-Alone option has full Closed Caption functionality, but other ES Analyzer functions are disabled.

XDS analysis is currently disabled. Extended Data Services is a supplementary data stream existing in Line 21, Field 2. It is used to provide additional data (primarily content advisory information) on the program being aired (Reference: EIA-744).

## Enabling Closed Caption Analysis

1. Open a stream containing Closed Captions.
2. Expand the navigation tree and open either a VES or a GOP node.
3. Enable Closed Caption Analysis in the Settings menu. A check mark next to the option indicates that Closed Caption Analysis is enabled.

---

**NOTE.** *By default, Closed Caption Analysis is enabled. It is recommended that it be only enabled when required; disabling it will improve the speed of picture analysis processing.*

*However, disabling and enabling the Closed Caption Analysis feature should only be done when a stream is first opened, not during analysis. Opening the feature during analysis may result in improper analysis.*

---

When Closed Caption Analysis is enabled, the Closed Caption Display tab will be visible in the Slice and MB GOP tab.

4. Ensure that the Picture Display Settings (Settings > Picture Display...) are as shown in the following screenshot:

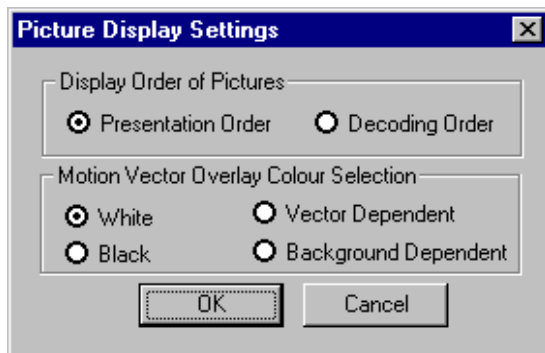

- Display Order of Pictures > Presentation Order
- Motion Vector Overlay Colour Selection > White

## Selecting Closed Caption Analysis Standard

Two primary forms of Closed Caption Analysis are offered: CC-EIA608 and CC-EIA708. CC-EIA746 support is also supported in the EIA608 mode.

The selection of CC-EIA608 or CC-EIA708 is made from the Closed Caption Display tab available in the Slice and MB GOP tab.

---

**NOTE.** *Whichever standard is selected, no closed caption content will be displayed until the file has been at least partially analyzed. To start analyzing the stream, select the GOP And Picture tab and press the Go button.*

---

A sign that closed caption content has been detected during analysis is that the Video icon in the navigation tree changes to include a CC symbol:

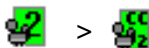

## CC-EIA608 Support

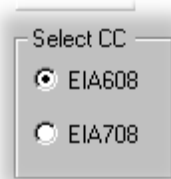

The following dialog box is displayed below the picture display (in the Closed Caption Display tab) when CC-EIA608 Closed Caption Analysis is enabled:

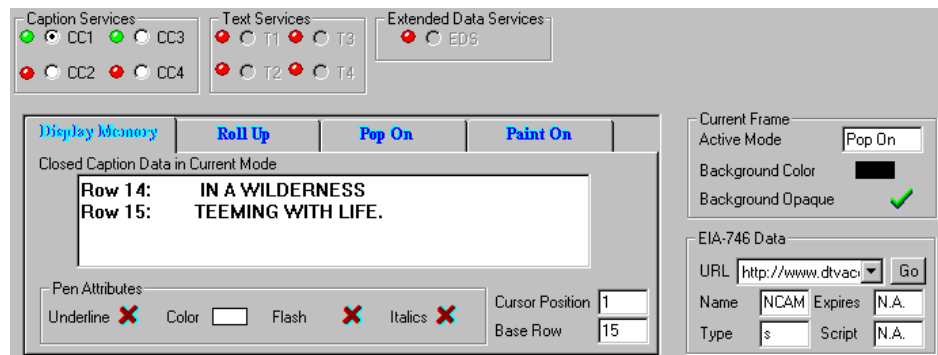

At the top of the display, the LED icons indicate that closed caption data has been received in the Field and Services sections; green indicates that data has been received.

If data has been received for the current GOP it should be displayed in the Display Memory tab and on the picture display:



The remaining tabs (Roll Up, Pop On and Paint On) display various parameters defining the manner in which the captions will be displayed.

### CC-EIA746 Support

Associated with CC-EIA608 is CC-EIA746 which supports the transmission of URLs (Uniform Resource Locators) within the closed caption data.

The URLs transmitted in the T2 closed caption service are parsed, decoded and displayed in the EIA-746 Data view.



- The attributes shown apply to the URL selected from the drop-down list.
- The selected URL is fetched and displayed on the default Web browser installed on the system.

### CC-EIA708 Support

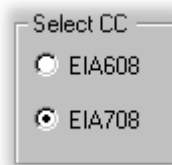

The following dialog box is displayed below the picture display (in the Closed Caption Display tab) when CC-EIA708 Closed Caption Analysis is enabled:

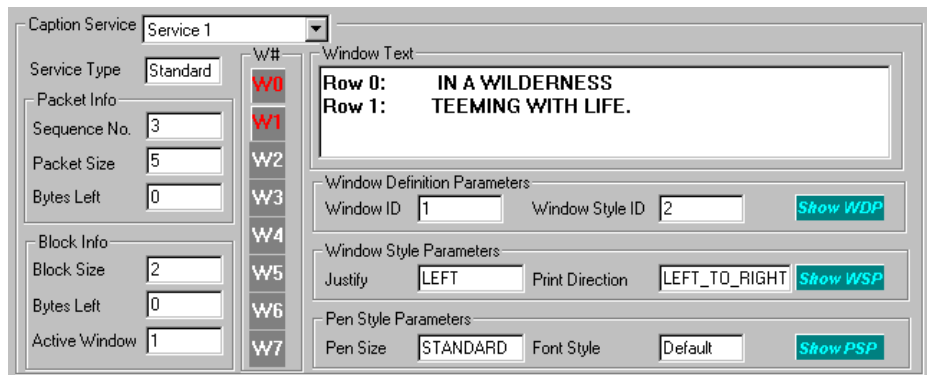

Details of the fields in the Closed Caption Analysis window are as follows:



**Caption Service** The service whose details are to be displayed can be selected from the drop-down list.

**Packet Info** Sequence No. The sequence number of the packet from which the current service block has been extracted (for example, Service 1, Service 2, etc).

Packet Size The packet size that has been coded in the packet header.

Bytes Left The number of bytes still to be received.

**Block Info** Block size The size of the service block.

Bytes Left The number of bytes still to be received.

Active Window The Window ID which is currently the active window.

**Window Identity**



W# The buttons in red in the W# column indicated the defined windows in the received service. The parameters to the right of this column depend on the selection made here.

**Window Text** The text shown in the current window.

**Window Definition Parameters**

By placing the cursor over the more... field all the parameters related to the window definition can be viewed.

WINDOW DEFINITION PARAMETERS	
PARAMETER NAME	PARAMETER VALUE
<i>Anchor Horizontal</i>	0
<i>Anchor Point</i>	0
<i>Anchor Vertical</i>	60
<i>Column Count</i>	32
<i>Column Lock</i>	NO
<i>Pen Style ID</i>	1
<i>Priority</i>	0
<i>Relative Positioning</i>	NO
<i>Row Count</i>	3
<i>Row Lock</i>	NO
<i>Visible</i>	NO
<i>Window ID</i>	1
<i>Window Style ID</i>	2

Window Definition Parameters

Window ID  Window Style ID  [more...](#)

Window Style Parameters

Justify  Print Direction  [more...](#)

Pen Style Parameters

Pen Size  Font Style  [more...](#)

**Window Style Parameters**

By placing the cursor over the more... field all the parameters related to the window styles can be viewed.

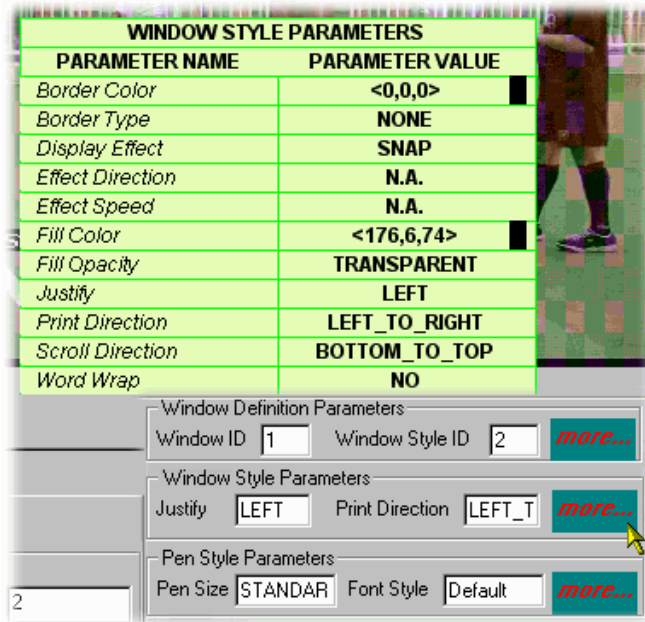

**Pen Style Parameters**

By placing the cursor over the more... field all the parameters related to the pen styles can be viewed.

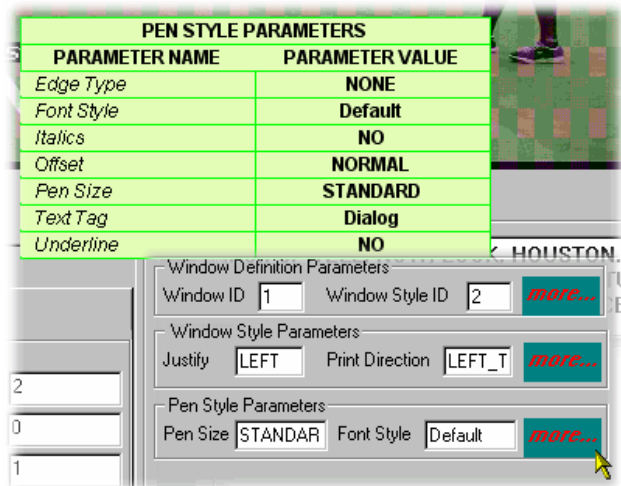

## Dumping Closed Caption Statistics

Closed Caption Analysis statistics can be written to file for each standard (EIA608 and EIA708).

---

**NOTE.** *Regardless of which standard is selected, no closed caption statistics can be dumped until the file has been at least partially analyzed. To start analyzing the stream, select the GOP And Picture tab and press the Go button.*

---

A sign that closed caption content has been detected during analysis is that the Video icon in the navigation tree changes to include a CC symbol:

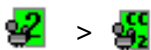

The sequence of actions required for a dump of statistics to be successful is as follows:

1. The Dump CC Statistics option in the Settings menu will only become available when analysis (or partial analysis) has established that Closed Caption data is carried in the stream.
2. A standard must be selected from the Dump CC Statistics option sub-menu, for example, EIA608.
3. A destination file must be specified for the statistics dump.
4. Further analysis must be carried out to provide data for the statistics dump.

The following paragraphs describe the setup required for each standard; however, the previous steps must be adhered to for the dump to be successful.

## EIA608 Closed Caption Statistics Dump

1. Select the EIA608 option from the Dump CC Statistics sub-menu.

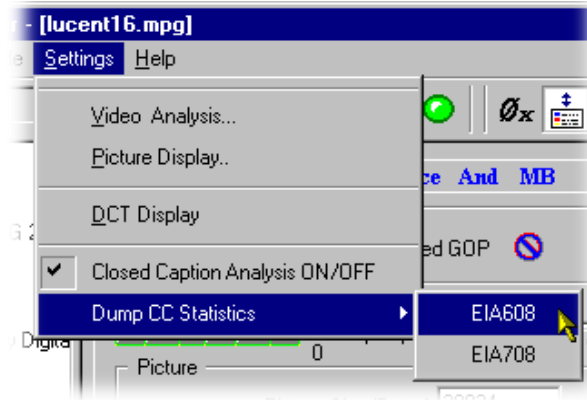

2. Enable Dump Statistics.

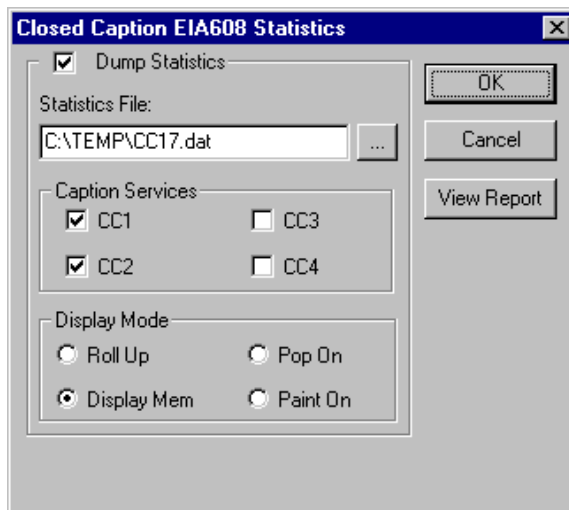

3. Identify a destination file in the Statistics File: field.
4. Enable the parameters to be dumped.
5. Select OK.

Existing reports (reports that you set up) can be viewed by selecting View Report.

## EIA708 Closed Caption Statistics Dump

1. Select the EIA708 option from the Dump CC Statistics submenu.

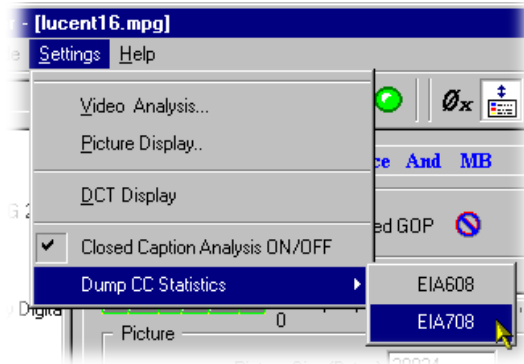

2. Enable Dump Statistics.

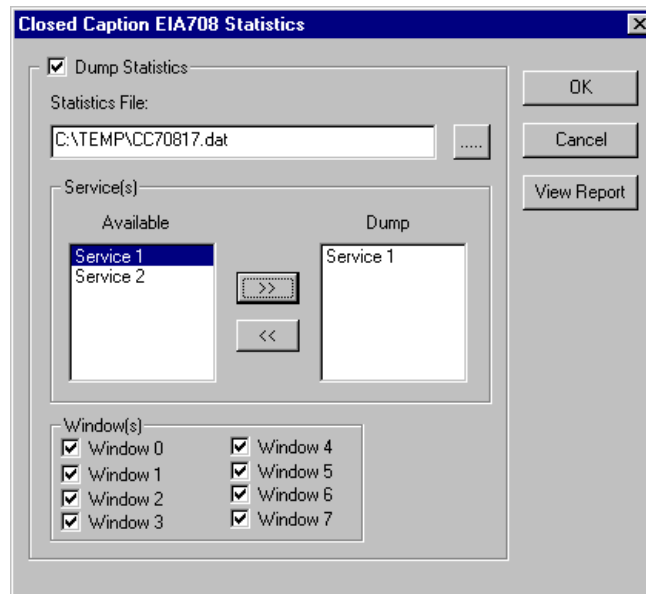

3. Identify a destination file in the Statistics File: field.
4. Enable the parameters to be dumped.
5. Select OK.

Existing reports (that is, reports previously set up) can be viewed by selecting View Report.

# DVB Subtitle Stream Analysis

DVB Subtitling provides a means of conveying region-based bit-mapped graphics as MPEG-2 packetized elementary streams (PES). The bit-mapped pixel images are run-length encoded and transmitted with color look-up tables (CLUT) to a decoder where the stream is decoded and the subtitle image rendered with the on-screen display.

When a DVB Subtitle node is revealed and highlighted, the screen shown below is displayed:

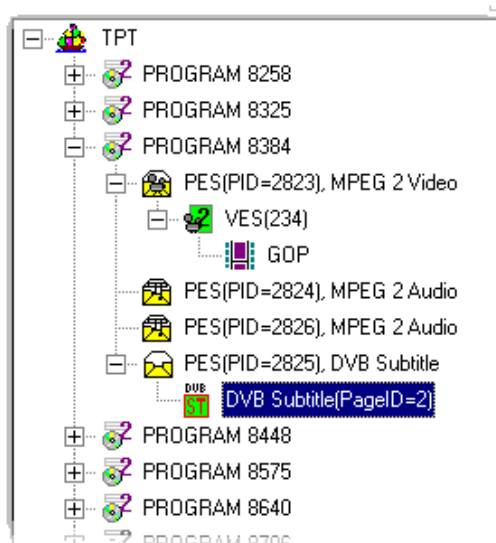

---

**NOTE.** Some streams may show subtitle nodes from which the Page View (described below) cannot display any subtitles.

*This is not an error, it is because the stream is too short to carry the requisite data. If possible, record a longer section of the stream and retry the analysis.*

---

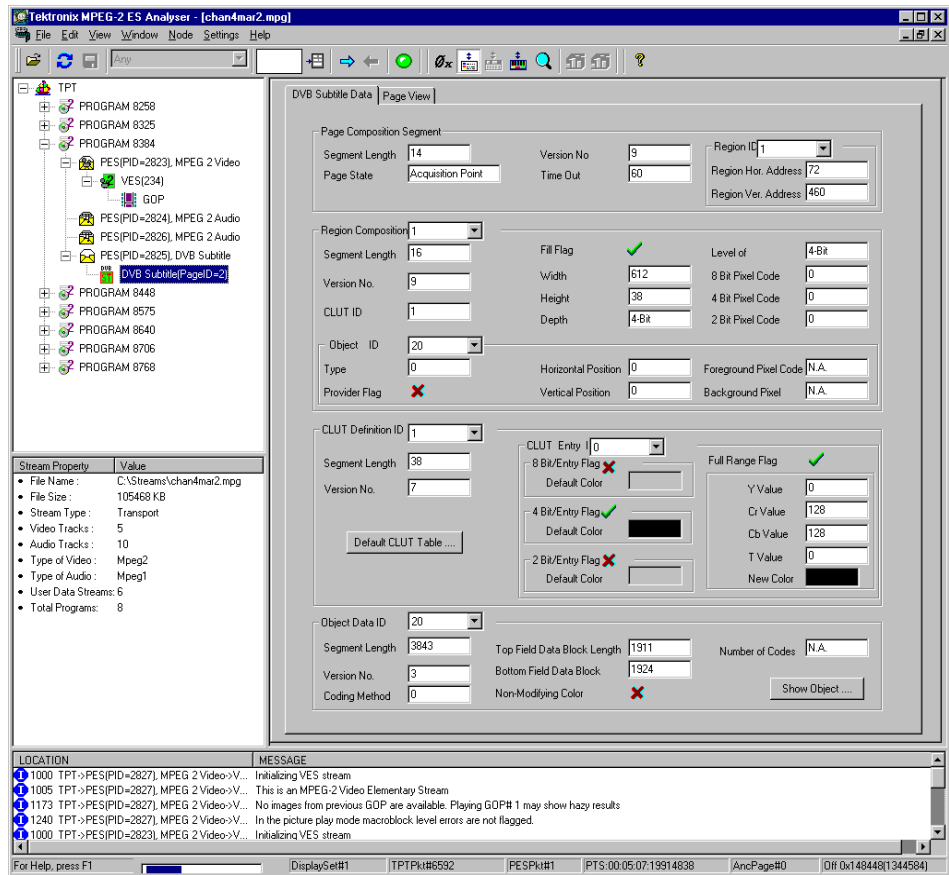

The working area contains two tabs: DVB Subtitle Data and Page View.



## DVB Subtitle Data Tab

The DVB Subtitle Data tab displays the fields associated with the current display. Access to two areas of detail is provided by pressing the Default CLUT Table... and the Show Object... buttons.

DVB Subtitle Data Page View

Page Composition Segment

Segment Length 14      Version No 9      Region ID 1

Page State Acquisition Point      Time Out 60      Region Hor. Address 72

Region Ver. Address 460

---

Region Composition 1

Segment Length 16      Fill Flag       Level of 4-Bit

Version No. 9      Width 612      8 Bit Pixel Code 0

CLUT ID 1      Height 38      4 Bit Pixel Code 0

Depth 4-Bit      2 Bit Pixel Code 0

---

Object ID 20

Type 0      Horizontal Position 0      Foreground Pixel Code N.A.

Provider Flag       Vertical Position 0      Background Pixel N.A.

---

CLUT Definition ID 1

Segment Length 38      CLUT Entry 0

Version No. 7

Default CLUT Table ...

8 Bit/Entry Flag       Default Color       Full Range Flag

4 Bit/Entry Flag       Default Color       Y Value 0

2 Bit/Entry Flag       Default Color       Cr Value 128

Cb Value 128

T Value 0

New Color

---

Object Data ID 20

Segment Length 3843      Top Field Data Block Length 1911      Number of Codes N.A.

Version No. 3      Bottom Field Data Block 1924

Coding Method 0      Non-Modifying Color       Show Object ...

**Object View**

The Object View displays a decoded bitmap of the selected object rendered on a blank screen (that is, with no underlying picture). The fields at the top of the dialog box, provide the user with the options of changing the decoder type (2-bit, 4-bit or 8-bit), the background color, and the CLUT identity. As described in the standard, the CLUT is attached to the region, not the object; therefore, the user can see the bitmap using all of the available CLUTs.

The Object view is displayed by selecting the Show Object... button on the DVB Subtitle Data tab.

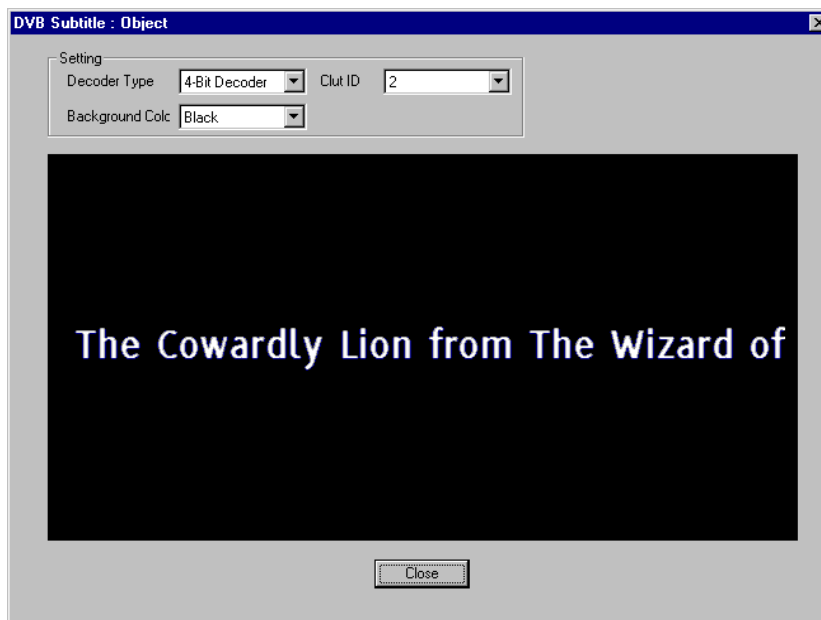

**CLUT View** The Object view is displayed by selecting the Default CLUT table... button on the DVB Subtitle Data tab.



**NOTE.** Subtitles in the UK are colored in a limited set, (red, cyan, green, yellow, white), one for each of four speakers/actors and white for additional speakers/actors.

## Page View Tab

On the Page view tab, the regions listed in the Page Composition Segment area of the DVB Subtitle Data tab are rendered on a blank screen (size 720(H) x 576(W) pixels). The regions and objects are rendered at their actual locations on the blank screen. The user can select the Decoder Type and Background Color from the drop-down lists.

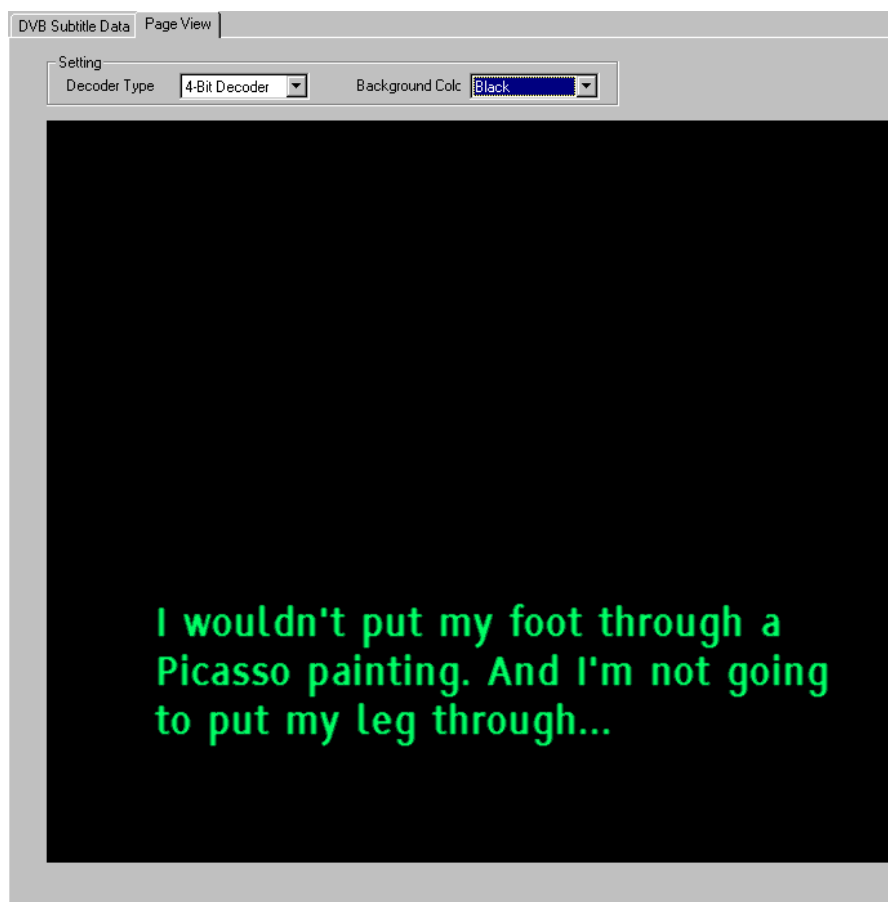

---

**NOTE.** Background color is not carried in the broadcast. The user can select a suitable color.

---

# User Manual



## **MTS400 Series MPEG Test Systems**

**Volume 2 of 2**

**071-1507-04**

This document applies to firmware version 1.4  
and above.

**[www.tektronix.com](http://www.tektronix.com)**

Copyright © Tektronix. All rights reserved. Licensed software products are owned by Tektronix or its subsidiaries or suppliers, and are protected by national copyright laws and international treaty provisions.

Tektronix products are covered by U.S. and foreign patents, issued and pending. Information in this publication supercedes that in all previously published material. Specifications and price change privileges reserved.

TEKTRONIX and TEK are registered trademarks of Tektronix, Inc.

## **Contacting Tektronix**

Tektronix, Inc.  
14200 SW Karl Braun Drive  
P.O. Box 500  
Beaverton, OR 97077  
USA

For product information, sales, service, and technical support:

- In North America, call 1-800-833-9200.
- Worldwide, visit [www.tektronix.com](http://www.tektronix.com) to find contacts in your area.

## Warranty 2

Tektronix warrants that this product will be free from defects in materials and workmanship for a period of one (1) year from the date of shipment. If any such product proves defective during this warranty period, Tektronix, at its option, either will repair the defective product without charge for parts and labor, or will provide a replacement in exchange for the defective product. Parts, modules and replacement products used by Tektronix for warranty work may be new or reconditioned to like new performance. All replaced parts, modules and products become the property of Tektronix.

In order to obtain service under this warranty, Customer must notify Tektronix of the defect before the expiration of the warranty period and make suitable arrangements for the performance of service. Customer shall be responsible for packaging and shipping the defective product to the service center designated by Tektronix, with shipping charges prepaid. Tektronix shall pay for the return of the product to Customer if the shipment is to a location within the country in which the Tektronix service center is located. Customer shall be responsible for paying all shipping charges, duties, taxes, and any other charges for products returned to any other locations.

This warranty shall not apply to any defect, failure or damage caused by improper use or improper or inadequate maintenance and care. Tektronix shall not be obligated to furnish service under this warranty a) to repair damage resulting from attempts by personnel other than Tektronix representatives to install, repair or service the product; b) to repair damage resulting from improper use or connection to incompatible equipment; c) to repair any damage or malfunction caused by the use of non-Tektronix supplies; or d) to service a product that has been modified or integrated with other products when the effect of such modification or integration increases the time or difficulty of servicing the product.

THIS WARRANTY IS GIVEN BY TEKTRONIX WITH RESPECT TO THE PRODUCT IN LIEU OF ANY OTHER WARRANTIES, EXPRESS OR IMPLIED. TEKTRONIX AND ITS VENDORS DISCLAIM ANY IMPLIED WARRANTIES OF MERCHANTABILITY OR FITNESS FOR A PARTICULAR PURPOSE. TEKTRONIX' RESPONSIBILITY TO REPAIR OR REPLACE DEFECTIVE PRODUCTS IS THE SOLE AND EXCLUSIVE REMEDY PROVIDED TO THE CUSTOMER FOR BREACH OF THIS WARRANTY. TEKTRONIX AND ITS VENDORS WILL NOT BE LIABLE FOR ANY INDIRECT, SPECIAL, INCIDENTAL, OR CONSEQUENTIAL DAMAGES IRRESPECTIVE OF WHETHER TEKTRONIX OR THE VENDOR HAS ADVANCE NOTICE OF THE POSSIBILITY OF SUCH DAMAGES.

### **Warranty 9(b)**

Tektronix warrants that the media on which this software product is furnished and the encoding of the programs on the media will be free from defects in materials and workmanship for a period of three (3) months from the date of shipment. If any such medium or encoding proves defective during the warranty period, Tektronix will provide a replacement in exchange for the defective medium. Except as to the media on which this software product is furnished, this software product is provided "as is" without warranty of any kind, either express or implied. Tektronix does not warrant that the functions contained in this software product will meet Customer's requirements or that the operation of the programs will be uninterrupted or error-free.

In order to obtain service under this warranty, Customer must notify Tektronix of the defect before the expiration of the warranty period. If Tektronix is unable to provide a replacement that is free from defects in materials and workmanship within a reasonable time thereafter, Customer may terminate the license for this software product and return this software product and any associated materials for credit or refund.

THIS WARRANTY IS GIVEN BY TEKTRONIX WITH RESPECT TO THE PRODUCT IN LIEU OF ANY OTHER WARRANTIES, EXPRESS OR IMPLIED. TEKTRONIX AND ITS VENDORS DISCLAIM ANY IMPLIED WARRANTIES OF MERCHANTABILITY OR FITNESS FOR A PARTICULAR PURPOSE. TEKTRONIX' RESPONSIBILITY TO REPLACE DEFECTIVE MEDIA OR REFUND CUSTOMER'S PAYMENT IS THE SOLE AND EXCLUSIVE REMEDY PROVIDED TO THE CUSTOMER FOR BREACH OF THIS WARRANTY. TEKTRONIX AND ITS VENDORS WILL NOT BE LIABLE FOR ANY INDIRECT, SPECIAL, INCIDENTAL, OR CONSEQUENTIAL DAMAGES IRRESPECTIVE OF WHETHER TEKTRONIX OR THE VENDOR HAS ADVANCE NOTICE OF THE POSSIBILITY OF SUCH DAMAGES.



# Table of Contents

General Safety Summary	iii
Preface	v
Related Material	v
Manual Conventions	vi

## Volume 1

<b>Introduction</b>	<b>1</b>
<b>Transport Stream Compliance Analyzer</b>	<b>2</b>
<b>PES Analyzer</b>	<b>3</b>
<b>T-STD Buffer Analyzer</b>	<b>4</b>
<b>Elementary Stream Analyzer</b>	<b>5</b>

## Volume 2

<b>Carousel Analyzer</b>	<b>6</b>
<b>Carousel Generator</b>	<b>7</b>
<b>Multiplexer</b>	<b>8</b>
<b>Transport Stream Editor</b>	<b>9</b>
<b>MPEG Player</b>	<b>10</b>
<b>Make Seamless Wizard</b>	<b>11</b>
<b>TS Cutter</b>	<b>12</b>
<b>Script Pad</b>	<b>13</b>
<b>Glossary</b>	



# General Safety Summary

Review the following safety precautions to avoid injury and prevent damage to this product or any products connected to it.

To avoid potential hazards, use this product only as specified.

*Only qualified personnel should perform service procedures.*

## **To Avoid Fire or Personal Injury**

**Use Proper Power Cord.** Use only the power cord specified for this product and certified for the country of use.

**Ground the Product.** This product is grounded through the grounding conductor of the power cord. To avoid electric shock, the grounding conductor must be connected to earth ground. Before making connections to the input or output terminals of the product, ensure that the product is properly grounded.

**Observe All Terminal Ratings.** To avoid fire or shock hazard, observe all ratings and markings on the product. Consult the product manual for further ratings information before making connections to the product.

**Power Disconnect.** The power cord disconnects the product from the power source. Do not block the power cord; it must remain accessible to the user at all times.

**Do Not Operate Without Covers.** Do not operate this product with covers or panels removed.

**Do Not Operate With Suspected Failures.** If you suspect there is damage to this product, have it inspected by qualified service personnel.

**Avoid Exposed Circuitry.** Do not touch exposed connections and components when power is present.

**Use Proper Fuse.** Use only the fuse type and rating specified for this product.

**Do Not Operate in Wet/Damp Conditions.**

**Do Not Operate in an Explosive Atmosphere.**

**Keep Product Surfaces Clean and Dry.**

**Provide Proper Ventilation.** Refer to the manual's installation instructions for details on installing the product so it has proper ventilation.

**Terms in this Manual**

These terms may appear in this manual:



---

**WARNING.** *Warning statements identify conditions or practices that could result in injury or loss of life.*

---



---

**CAUTION.** *Caution statements identify conditions or practices that could result in damage to this product or other property.*

---

**Symbols and Terms on the Product**

These terms may appear on the product:

- DANGER indicates an injury hazard immediately accessible as you read the marking.
- WARNING indicates an injury hazard not immediately accessible as you read the marking.
- CAUTION indicates a hazard to property including the product.

The following symbols may appear on the product:



# Preface

This manual describes the functions and use of the Tektronix MTS400 Series MPEG Test System. After the introduction, each section of the manual describes one of the software applications or tools that make up the MTS400 Series system

Other documents are available on the Tektronix Web site ([www.tektronix.com](http://www.tektronix.com)):

- *MTS400 Series MPEG Test System Getting Started Manual (071-1505-xx)*
- *MTS400 Series MPEG Test System Programmer Manual (071-1725-xx)*  
This manual specifies the remote control and status monitoring interfaces available to a management application.

## Related Material

Additional documentation, such as Read Me files, may be included on the installation disks.

The following URLs access the web sites for the standards organizations listed (the URLs listed were valid at the time of writing):

- MPEG-2 standards (International Organization for Standards)  
<http://www.iso.ch/>
- DVB standards (European Technical Standards Institute)  
<http://www.etsi.org/>
- ATSC standards (Advanced Television Systems Committee)  
<http://www.atsc.org/>
- ISDB/ARIB standards (Association of Radio Industries and Businesses)  
<http://www.arib.or.jp/english/>
- SCTE Society of Cable Television Engineers  
<http://www.scte.org/>

## Manual Conventions

Naming conventions for the interface elements are based on standard Microsoft Windows naming conventions. Naming conventions for MPEG-2, ATSC, and DVB structures follow the conventions derived from the standards listed above. In addition, the following formatting conventions apply to this manual:

- **Bold** text refers to specific interface elements that you are instructed to select, click, or clear.  
Example: Select **Settings** from the Configuration menu.
- Mono-spaced text can indicate the following:
  - Text you enter from a keyboard  
Example: Enter the network identity (`http://TSMonitor01`)
  - Characters you press on your keyboard  
Example: Press CTRL+C to copy the selected text.
  - Paths to components on your hard drive  
Example: The program files are installed at the following location:  
`C:\Program Files\Tektronix\`



# **Carousel Analyzer**





# Table of Contents

<b>Carousel Analyzer - Getting Started</b> .....	<b>6-1</b>
Data Broadcasting Overview .....	6-3
Starting the Program .....	6-4
<b>Menus and Controls</b> .....	<b>6-13</b>
Menu Options .....	6-13
Toolbars .....	6-17
Transport Packet Bar .....	6-19
Status Bar .....	6-20
Workspace .....	6-21
<b>Views</b> .....	<b>6-27</b>
Programs/Services View .....	6-30
Object Carousel View .....	6-34
U-N-Download View .....	6-41
Data Carousel (DVB) View .....	6-45
Data Carousel (ARIB) View .....	6-46
Resource View .....	6-50
Structure Views .....	6-52
Bitrate View .....	6-55
Repetition View .....	6-58
PID View .....	6-61
Log View .....	6-64
Cycle Times View .....	6-67
<b>Application Support</b> .....	<b>6-71</b>
Application Management .....	6-71
Application Definition .....	6-73
Application Timing .....	6-78
<b>MHP Support</b> .....	<b>6-91</b>
Application Lifetimes .....	6-93
<b>Reference</b> .....	<b>6-95</b>
Script Files .....	6-95
Error Checking .....	6-96
References .....	6-97

## List of Figures

<b>Figure 6–1: Main Window - Intial Appearance</b> .....	<b>6–4</b>
<b>Figure 6–2: DVB Programs/Services view (typical)</b> .....	<b>6–30</b>
<b>Figure 6–3: ARIB Programs/Services view (typical)</b> .....	<b>6–31</b>

## List of Tables

<b>Table 6–1: File menu options</b> .....	<b>6–5</b>
<b>Table 6–2: View menu options</b> .....	<b>6–5</b>
<b>Table 6–3: Analysis menu options</b> .....	<b>6–6</b>
<b>Table 6–4: File menu options</b> .....	<b>6–13</b>
<b>Table 6–5: Edit menu options</b> .....	<b>6–13</b>
<b>Table 6–6: View menu options</b> .....	<b>6–14</b>
<b>Table 6–7: Graph menu options</b> .....	<b>6–15</b>
<b>Table 6–8: Window menu options</b> .....	<b>6–16</b>
<b>Table 6–9: Help menu options</b> .....	<b>6–17</b>
<b>Table 6–10: Key to Tree Nodes</b> .....	<b>6–28</b>
<b>Table 6–11: Script Files - General</b> .....	<b>6–95</b>
<b>Table 6–12: Script Files - Carousel Analyzer</b> .....	<b>6–96</b>

# Carousel Analyzer - Getting Started

The Digital Storage Media Command and Control (DSM-CC) protocol was originally developed to provide a VCR-like control mechanism for program material delivered in an MPEG2 transport stream. Since then, the standard has evolved to encompass a wide variety of applications including data broadcasting and interactive television. DSM-CC forms a core part of a variety of both closed and open standards such as the DVB MHP (Multimedia Home Platform) standard for European Interactive Television.

The following DTV standards are supported:  
(See page 6–97 for details of all references in this section.)

- ISO/IEC 13818-6 Information technology - Generic coding of moving pictures and associated audio information - Part 6: Extension for Digital Storage Media Command and Control [MPEG] (Reference [2])
- EN 301 192 Specification for data broadcasting [DVB] (Reference [4])
- ARIB STD - B24 Data Coding and Transmission Specification for Digital Broadcasting (Reference [11])
- Multimedia Home Platform [DVB] (Reference [12])

A bibliography of DTV standards documentation is given in the *Reference* section.

The Tektronix Carousel Analyzer has been developed to meet the specific need to analyze and display the content and structure of data broadcasts. The tool provides a variety of ways of looking at a transport stream and its contents including displaying the bit rate, repetition rates, structure, syntax, and semantics of data items.

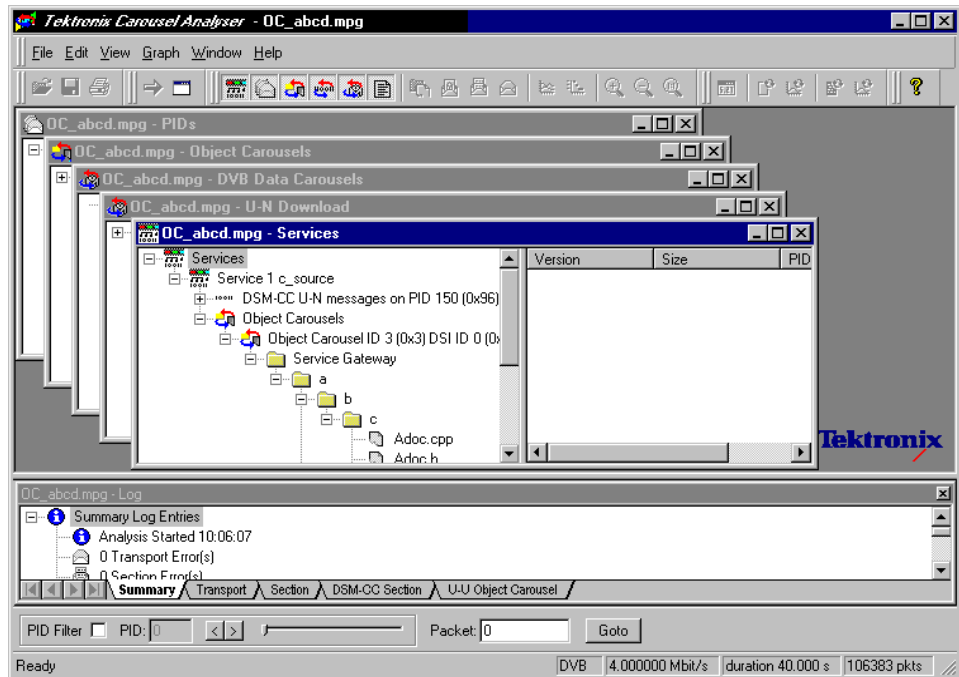

The program view shows the various services in the transport stream and their associated PIDs and data streams. Object or data (one or two layer) carousels and U-U or U-N messages such as DSM-CC Download can also be displayed with options to view associated, sections, carrier modules, or transport packets for each version as required.

An object carousel in the stream can be viewed by contents as a directory structure containing the underlying objects such as Java classes, picture, or text files. If an object is associated with an installed application then a double-click will launch that program, providing, for example, an easy and quick way to view the contents of a picture file or read a text file.

The structure of the U-N download messages can be viewed showing the relationship between DII, modules and blocks. The associated DSI and DII messages contained in the U-N-Download tables can also be viewed in interpreted or hex fashion; these indicate where to find and view the BIOPs that contain a required object in the stream.

The timing relationships between the various components can also be easily shown because the bit rates or the repetition rates of blocks, modules, objects, U-N messages or SI tables can be shown together in a single graphical display.

## Data Broadcasting Overview

Data Broadcasting allows data to be transmitted in a similar way to the way in which video and audio services are delivered to end users. Object and Data Carousels are intended for the periodic transmission of information in a transport stream. DVB Data Carousels contain modules of data of unspecified content. ARIB Data Carousels and Object Carousels contain identifiable data objects, for example, JPEG files, text files, and application software. Multimedia Home Platform (MHP) is also supported because the Application Information Table (AIT) and Object Carousels (as specified in the MHP standard) can be viewed.

The diagram below shows how information carried by data and object carousels is subdivided and ultimately carried by the transport stream.

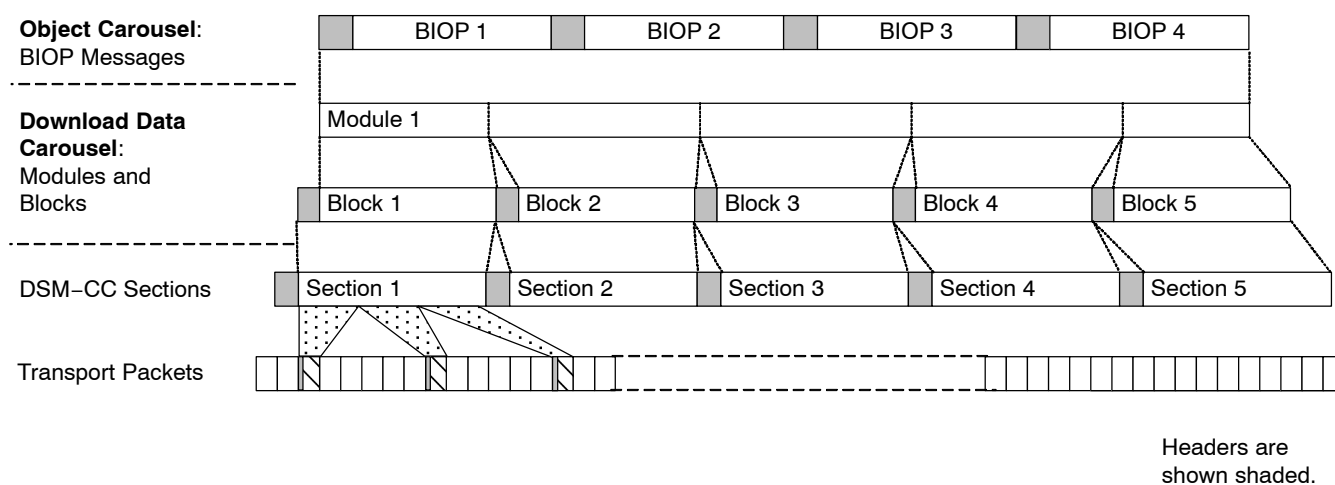

BIOP messages contain a message header, a message sub-header and the message body which contains data. The message body may contain complete data objects.

BIOP messages are broadcast in Modules. A Module is formed from one or more concatenated, complete BIOP messages.

Each Module is fragmented into one or more Download Data Blocks which are in turn transmitted in corresponding DSM-CC Sections.

Sections are transmitted in packets in the Transport Stream.

The Carousel Analyzer enables each layer of the protocol stack to be analyzed and inspected. The following sections provide an overview of how the Carousel Analyzer can be used to locate messages and packets of interest.

## Starting the Program

The program can be started by selecting the **Tektronix Carousel Analyzer** option from the **Start > Programs > Tektronix Data Applications V2.0** menu or by double clicking on the **Tektronix Carousel Analyzer** shortcut on the desktop.

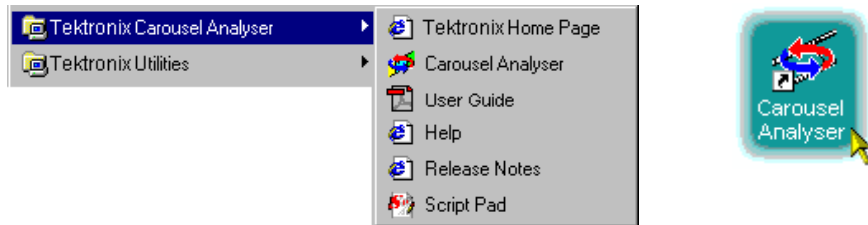

### Initial Appearance

When the program has started and is ready for use, it will open the Main window, as shown in Figure 6-1:

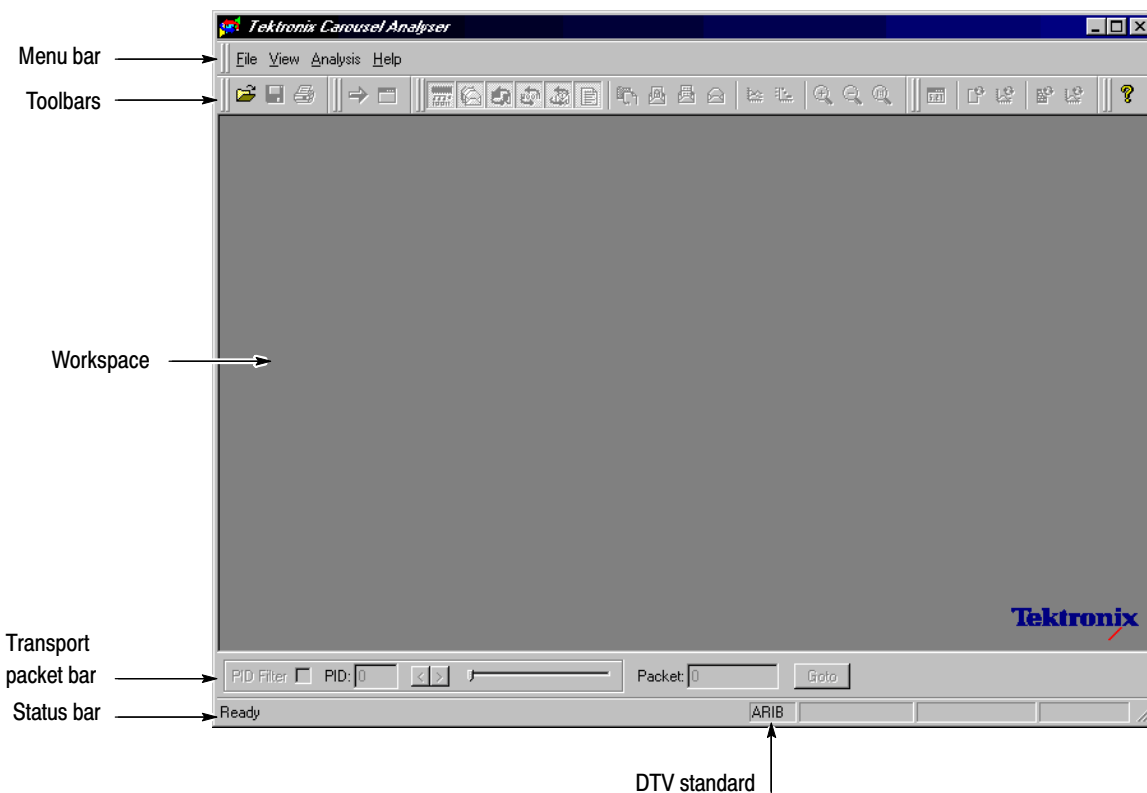

Figure 6-1: Main Window - Initial Appearance

Elements of the main window can be hidden during a session, but will be restored at start-up.

The Menu Bar contains all options available to the application; disabled options are visible but grayed out. The Toolbars provide shortcuts to the more important menu options; similarly, disabled buttons are visible but grayed out. The Transport Packet Bar provides controls to locate and jump to transport packets. The Status Bar shows stream information and the cursor message field.

**Initial Menu Options**

The Carousel Analyzer presents different menus and options depending upon whether or not a stream is open for analysis. The menu options available when no stream is open are as follows:

**File Menu Options.** Table 6–1 lists the options in the initial File menu.

**Table 6–1: File menu options**

Option	Function
<b>Open...</b>	Opens an MPEG transport stream for analysis. The program opens the file selection dialogue allowing the user to choose the required file.
<b>Print Setup...</b>	Opens a dialog for selecting which printer and associated options to use.
<b>1 &lt;&lt;filename&gt;&gt; 2 &lt;&lt;filename&gt;&gt; 3 &lt;&lt;filename&gt;&gt; 4 &lt;&lt;filename&gt;&gt;</b>	A list of the four most recently analyzed files. If the program has recently been installed, the list may be empty or hold less than four files.  Selecting a filename opens that file for analysis.
<b>Exit</b>	Finishes running the program.

**View Menu Options.** Table 6–2 lists the options in the initial View menu.

**Table 6–2: View menu options**

Option	Function
<b>Toolbars &gt;</b>	Submenu shows or hides the toolbar.
<b>Transport Packet Bar</b>	Shows or hides the Transport Packet Bar.
<b>Status Bar</b>	Shows or hides the status bar.

**Analysis Menu Options.** Table 6–3 lists the options in the initial Analysis menu.

**Table 6–3: Analysis menu options**

Option	Function
<b>Set Interpretation &gt;</b>	Select the Digital TV standard to be used for stream analysis.
<b>Settings...</b>	Displays a dialog for selecting scripts to be used during analysis.

**Stream Interpretation**

The DTV standard to be used for analysis must be selected before any streams are opened.

Select the required standard from the submenu.

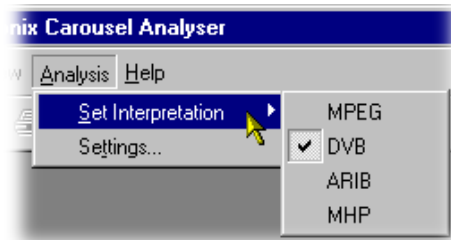

**Script Selection And Manipulation**

Scripts are available to the Carousel Analyzer to enable structures to be analyzed successfully.

If any script is not selected or enabled, the stream will not fail to be analyzed, but any data normally interpreted by that script would be ignored.

Scripts can only be selected and enabled when no files are open. The option is not available when a file is open.

**Handling Script Files.** To open the Analysis Settings dialog box, select Settings... from the Analysis menu.

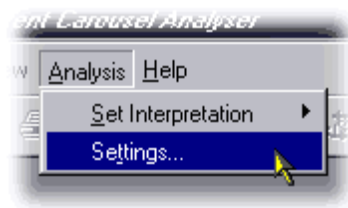



The dialog box shown below is displayed:

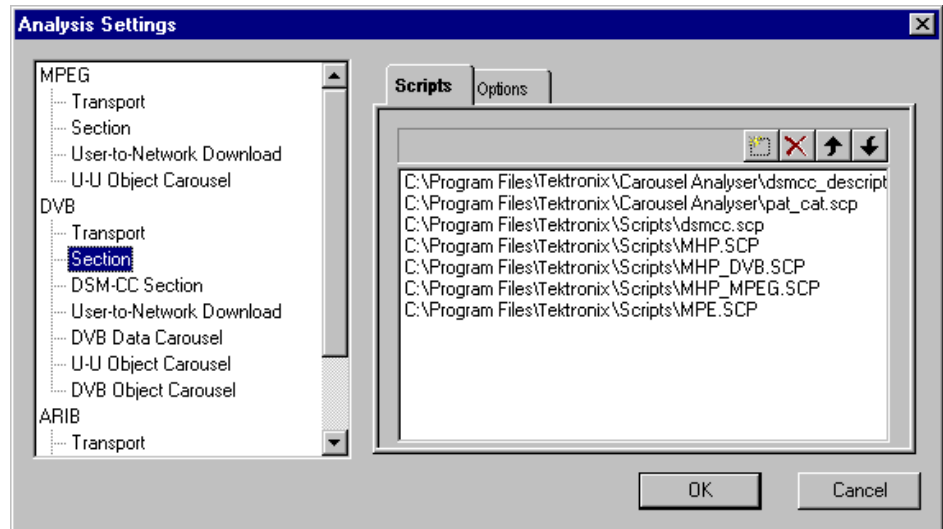

In the Analysis Settings dialog, the left window shows a tree structure of the test protocols available. The right window shows the scripts currently allocated to the test protocol; in the example, the listed scripts are associated with the DVB - Section protocol. The right window also contains the controls needed to manipulate the scripts.

Note that across the standards, the scripts are not hierarchical; that is, each DTV standard must be self-contained in terms of the scripts that it uses.

The currently available script files are listed in the *Reference* section (page 6–97).

The following paragraphs describe the available script manipulation activities. The activities are applied to the currently selected test protocol.

### Adding a Script file.

1. With the required test protocol highlighted, select the Add New Script button (Shortcut key: Insert).
2. If the script path/name is known, enter it into the blank field.

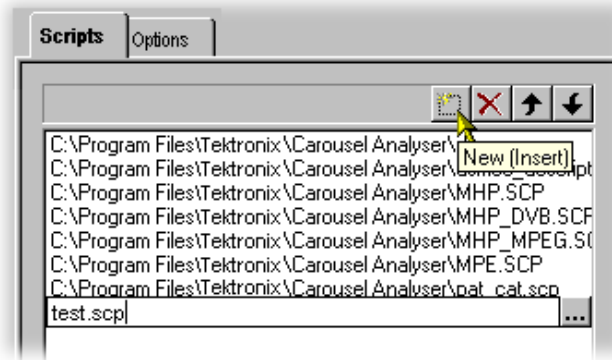

If the script name is unknown, use the browse button at the right side of the blank field to display a standard Windows file Open dialog box.

3. The new script file name will be added at the bottom of the script list. Note that script files are parsed in the order that they are listed, because the file may require moving up in the list – see *Moving Script files in the list* below.

### Removing a Script File.

1. Highlight the file to be deleted and select the Delete Script button (Shortcut key: Delete).

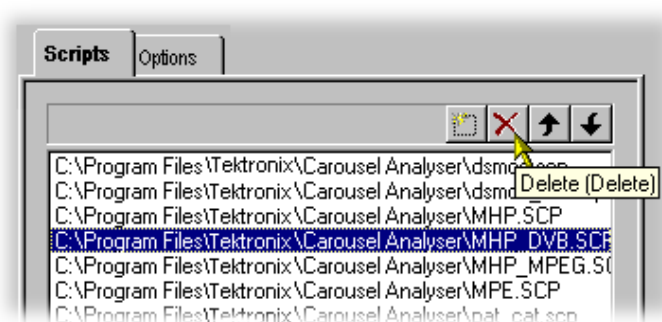

**Moving Script Files in the List** Script files are parsed in the order that they are listed; the file may require moving up in the list

1. Highlight the file to be moved and select either the Move Up or Move Down button (Shortcut keys: Alt-▲ and Alt-▼ respectively). The file will move up or down one place for each press of the button.

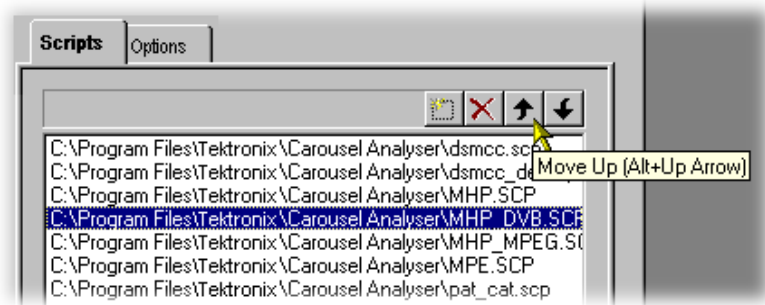

### Syntax Checking Options

A number of options are available from the Analysis Settings dialog that allow strict syntax checking to be enabled and disabled.

If any option is not enabled, the relevant syntax will not fail to be checked, but will be interpreted more loosely.

Syntax Checking Options can only be selected and enabled when no files are open. The option is not available when a file is open.

Currently, three syntax checking options are available:

**Strict private data length/Message length checking.** Object: U-U Object Carousel  
 Disabling this option allows the privateDataLength field where it exists in the DSI to be set to zero. The application will calculate it when required, using the total message length and the position of the private data in the message.  
 (See reference [2], sections 2 and 7.3.6.)

**Strict association tag checking.** Object: U-U Object Carousel  
 The association tag field in the stream\_identifier\_descriptor is an 8-bit value, while the same field in an object carousel is a 16-bit value. When comparing these two values, the MSB of the 16-bit value should be zero. Disabling this option allows it to take other values.  
 (See reference [4], 9.3 paragraph 3 and [6], paragraph 4.7.7.3.)

**Strict CRC/Checksum checking.** Object: DSM-CC Section

section\_syntax\_indicator and private\_indicator fields should be the complement of each other to determine whether a CRC or checksum is in use. Disabling this option allows them to be the same and allows the application to work out which method should be applied.

(See reference [2], section 9.2.2 paragraphs 3 and 4.)

**Enabling a Syntax Checking Option.** To open the Analysis Settings dialog box select Settings... from the Analysis menu.

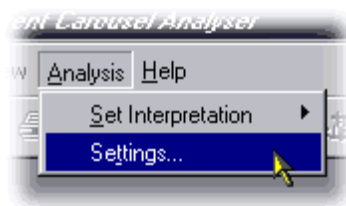

Select the Options tab. The dialog shown below is displayed:

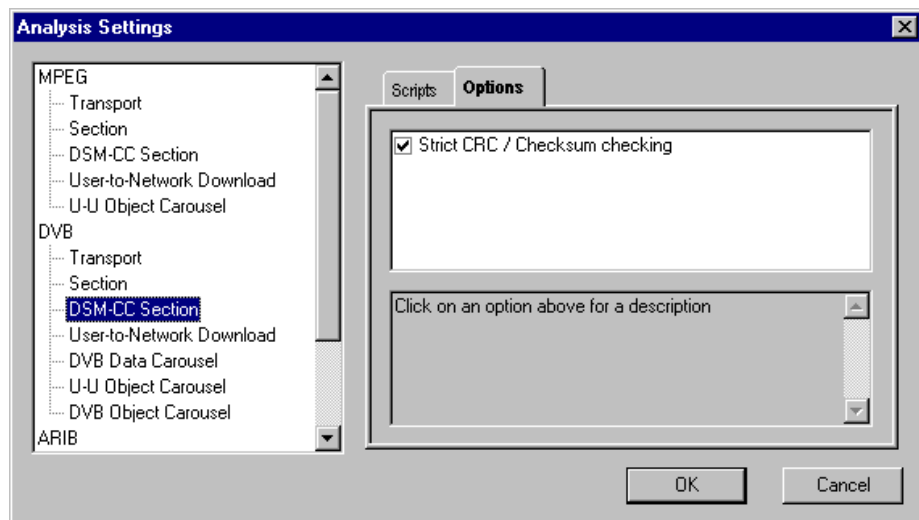

In the Analysis Settings dialog box, the left window shows a tree structure of the test protocols available. The right window shows the options currently allocated to the test protocol; note that currently, options are only applicable to DSM-CC Sections and U-U Object Carousels. Available options are applicable to all standards, for example, an option set in the DVB DSM-CC Section will be applied in the MPEG and ARIB protocols.

## Opening a Stream File

Any Transport Stream file can be opened for browsing by the Carousel Analyzer. However, only those streams containing Data and/or Carousel Objects will provide meaningful results. Tektronix's Transport Stream Analyzer should be used for normal stream analysis. Only one file can be opened at a time.

To open a file, select **File > Open...** If the required file is in the list of recently analyzed files, then it can be opened from the list to save using the open file dialog box.

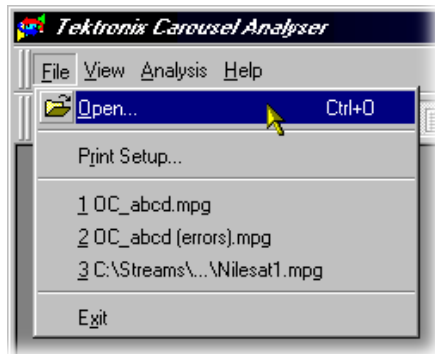

Alternatively, use the Ctrl+O keyboard shortcut.

There is a shortcut button available on the Toolbar for opening a file, which uses the standard file open symbol:

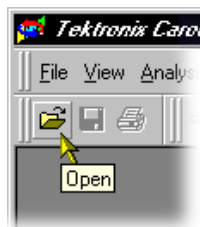

As the file opens, a progress bar is displayed; analysis may require more than one pass through the transport stream file. The current pass number is shown in the title line. After the first pass, a second progress bar (new resolved links) shows the number of unresolved links at each pass.

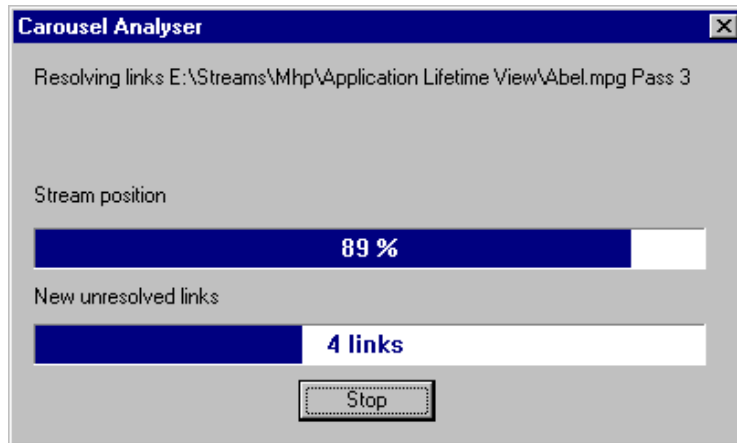

Analysis can be halted at any time by selecting the **Stop** button in the dialog box; the stream is still opened, but only the elements that have been analyzed so far will be displayed.

By default, the Services window and the Log window open as soon as a stream file opens. Further windows can be opened by using the View Menu or the Toolbar. Note that although the options on the View menu remain the same, they are enabled or disabled according to which protocol element is highlighted at the time.

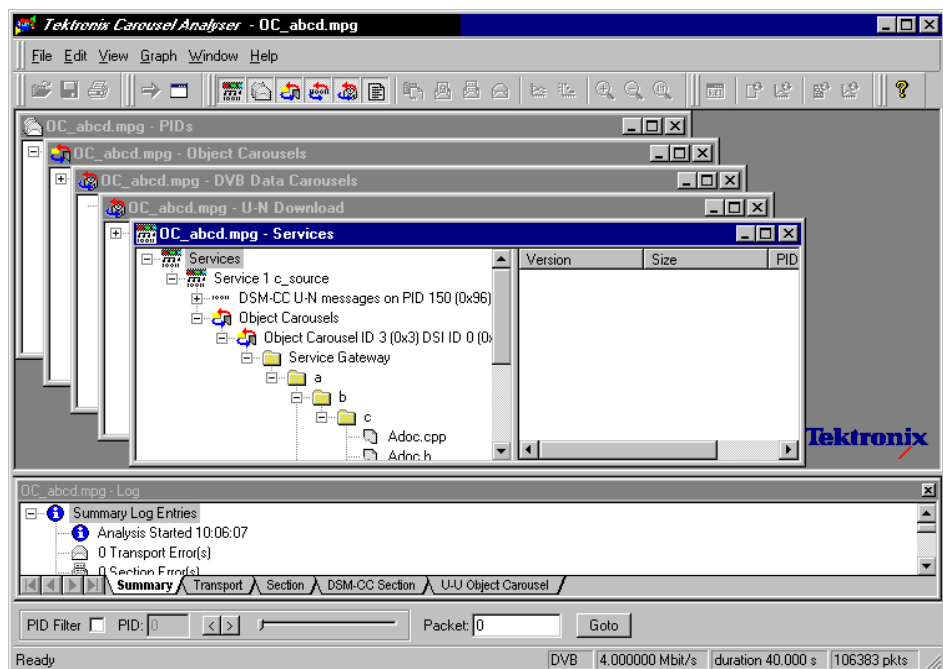

# Menus and Controls

The following pages contain descriptions of the menu options, toolbar controls, status bars, and methods for managing the workspace.

## Menu Options

The following pages describe all of the menu options. Since many of the options are context sensitive, they will be available only when their function is appropriate for the selected window or display element. When a menu option is not available, the option is grayed out.

**File Menu Options.** Table 6–4 shows the options available in the File menu.

**Table 6–4: File menu options**

Command	Function
Open...	Open an MPEG transport stream for analysis. The program opens the file selection dialogue box allowing the user to choose the required file.
Close	Closes the current file.
Save As...	Saves the file to a new file name.
Print	Opens the Print dialog.
Print Preview	Opens the Print Preview dialog.
Print Setup...	Opens the Print Setup dialog.
Exit	Closes any file that is open and terminates execution of the program.

**Edit Menu Options.** Table 6–5 shows the options available in the Edit menu.

**Table 6–5: Edit menu options**

Command	Function
Applications	Opens the Application Management dialog.
Go To Next	Jumps to next occurrence of the structure being viewed. The Packet field in the Transport Packet bar will reflect the change of packet.

**View Menu Options.** Table 6–6 shows the options available in the View menu.

**NOTE.** An active (depressed) button next to an option indicates that the window or toolbar is currently visible; an inactive button means that it is hidden.

**Table 6–6: View menu options**

Command	Function
<b>Toolbars &gt;</b>	Submenu shows or hides the toolbar. 
<b>Transport Packet Bar</b>	Shows or hides the Transport Packet Bar.
<b>Status Bar</b>	Shows or hides the Status Bar.



The remaining options in this menu open and close the associated window. The options and windows are described elsewhere in this section.

- Program/Services, U-N Download, Object Carousels, Data Carousels, PIDs and Log.
- BIOP Message, U-N Message, Section, Transport Packet, Transport Packet List, Hex Dump, Timing, Carrier and Resources.
- Repitition and Bitrate.



**Graph Menu Options.** Table 6–7 shows the options available in the Graph menu.

**Table 6–7: Graph menu options**

Command	Function
<p><b>Zoom</b></p>	<p>Applies to Bitrate and Repetition views only.</p>  <p><b>Zoom In:</b> Maximizes the central 50% (x-axis) of the current graph.</p> <p><b>Zoom Out:</b> Takes one step back in the Zoom sequence.</p> <p><b>Show All:</b> Resets the graph to show all points.</p>
<p><b>Save</b></p>	<p>Saves the graph in the selected format.</p> 
<p><b>Copy</b></p>	<p>Copies the graph to the clipboard in the selected format.</p> 

**Window Menu Options.** Table 6–8 shows the options available in the Window menu.

**Table 6–8: Window menu options**

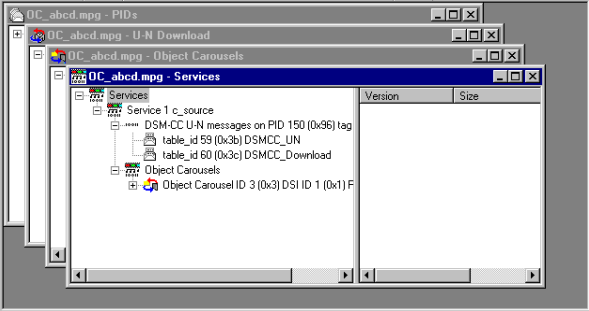
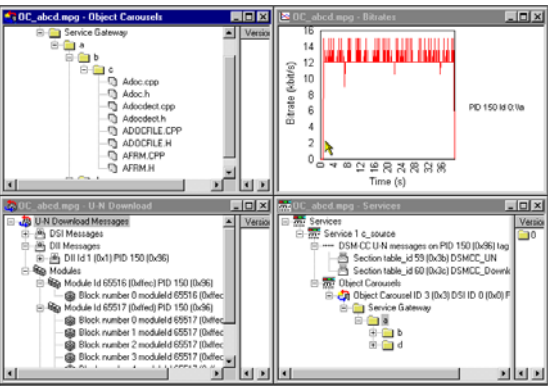
Command	Function
<p><b>Cascade</b></p>	<p>Rearranges the windows like this:</p> 
<p><b>Tile</b></p>	<p>Tiles the windows. For example, four windows would be tiled like this:</p> 
<p><b>Arrange Icons</b></p>	<p>Aligns icons of any minimized windows at the bottom of the program's main window.</p>
<p>1 &lt;&lt;window title&gt;&gt; 2 &lt;&lt;window title&gt;&gt; 3...etc</p>	<p>Makes the named window active, putting it on top of any windows that had been hiding all or part of it.</p>

**Help Menu Options.** Table 6–9 shows the options available in the Help menu.

**Table 6–9: Help menu options**

Command	Function
Quick Help	Opens the Quick Help browser window.
About Carousel Analyzer	Opens a message box that displays the program version number and license number. This information will be required if <b>Tektronix</b> Technical Support is contacted.

## Toolbars

Quick access buttons are divided between several toolbars: File, Edit, View and Help.

A number of the toolbar functions are context-sensitive; which window is open and which element is highlighted will dictate which buttons are enabled and disabled.

### File Toolbar



Open a file. This button is disabled when a file is open.



Save As... - BIOP file messages can be saved to separate files. Structures can also be saved to a separate file.



















Print – only available for bit rate and repetition views.

### Edit Toolbar









Jumps to next occurrence of the structure being viewed.

**View Toolbar** The buttons in this toolbar open and close the associated windows. The windows are described elsewhere in this manual.

	View Programs/Services		View Section
	View PIDs		View Transport Packet
	View Object Carousels		View Bitrate
	View Data Carousels		View Repetition Rate
	View U-N Download Messages		View Lifetime
	View Log		Zoom In
	View BIOP Message		Zoom Out
	View U-N Message		Show All

**Timing Toolbar**

	Edit Application Timing		View Carousel Cycle Time
	View Entity Cycle Time		View Carousel Cycle Time Graph
	View Entity Cycle Time Graph		

**Help Toolbar**  **About Carousel Analyzer:** Opens a dialog box which displays the program version number and license number. This information will be required if a **Tektronix** Technical Support is contacted.

## Transport Packet Bar

The Transport Packet bar provides a quick method of locating and navigating to transport packets PIDs.

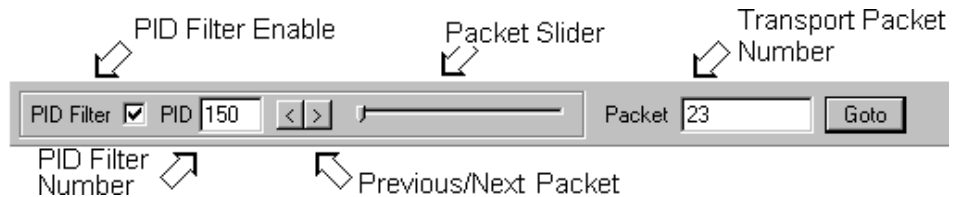

**Packet:** To locate a particular Transport Packet, enter the Transport Packet number and select Goto.

**PID Filter enable:** The PID navigation feature can be enabled by selecting the checkbox (as shown).

To navigate to a specific packet: with the PID Filter disabled, enter the packet number and select either the Previous or Next Packet button. If a PID structure view is now requested from a View, the search for the PID will commence with the transport packet number displayed.

Similarly, with the PID Filter enabled, each press of either the Previous/Next button will display the previous/next transport packet containing the PID number displayed in the PID Number field. If a PID structure view is now requested from a View, the search for the PID will commence with the transport packet number displayed.

**NOTE.** When a Transport Packet is viewed, the number in the Packet field will increment by one.

The Transport Packet bar can be hidden from view by using the View menu Toolbars option.

## Status Bar

The Status bar provides information about the stream that is currently being displayed. A message field gives a description of the button, menu or option that the cursor is resting on; other non-critical messages may also be shown.

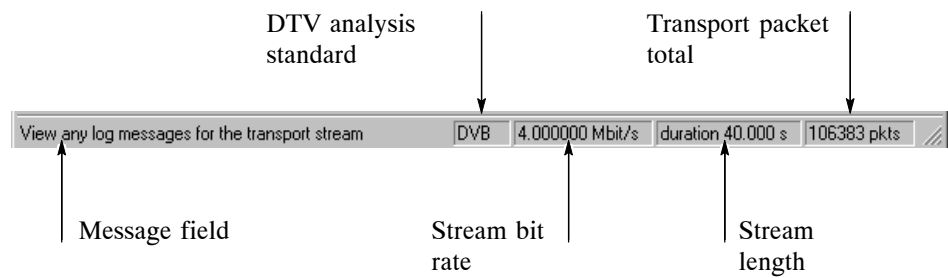

# Workspace

## Window Management

In addition to the generic Cascade and Tile options available from the window menu, management of individual windows is provided through a submenu available by right-clicking the title bar of the individual window.

Right-click window title bar:



Each window within the workspace can be designated as Docked, Floating, or as an MDI Child.

**Docked.** When docked, a window will be automatically placed against one of the four sides of the workspace.

For example, selecting **Docked > Top** will dock the selected window at the top of the workspace.

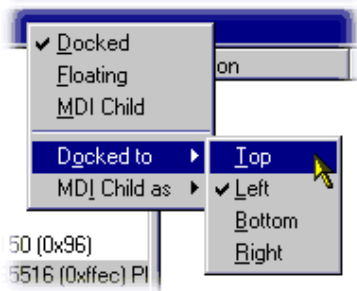

**Floating.** Designating a window as floating allows it to be moved around on the monitor desktop independently of the Carousel Analyzer interface.

For example, selecting Floating will allow the window to be moved anywhere on the desktop:



**MDI Child.** Designating a window as an MDI Child allows it to be moved anywhere within the workspace.

The MDI Child submenu allows the window to be designated as Restored, Minimized or Maximized.

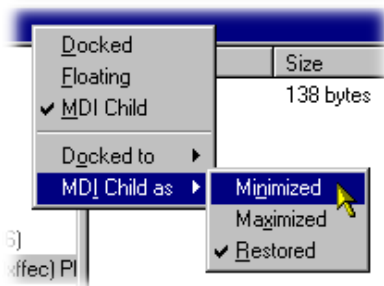

---

**NOTE.** When a window is “docked” it can be dragged (and dropped) around the workspace; when it is at an edge it will adopt a docked position. MDI Children do not attempt to dock with the edges of the workspace.

---



### Version/Size Pane Display

Most of the views described later use a split-pane arrangement to display the view data and related version, file size and PID information. The information is displayed in the right pane. However, the default arrangement when opening the view is that the right pane is closed. To open the pane, pass the cursor over the right edge of the view until it changes to the split pane cursor, then move the dividing bar to the desired position.

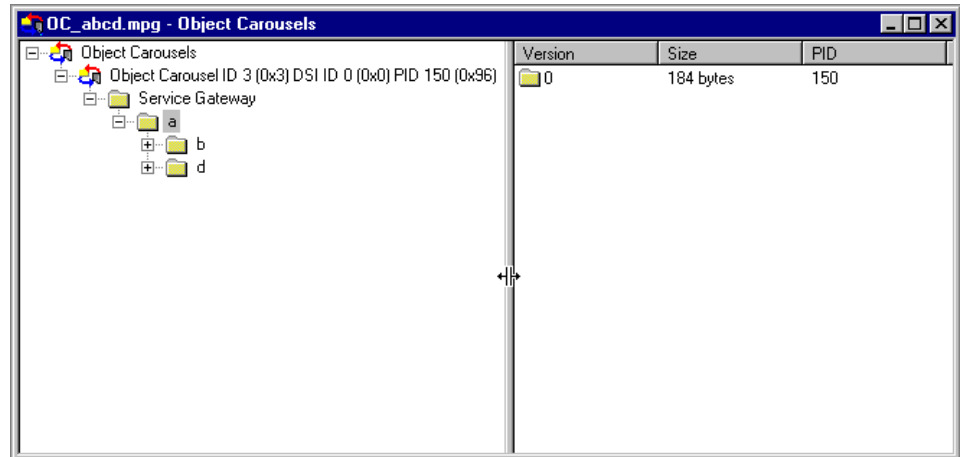

### Content Management

The principles employed in displaying the information in each workspace window are applicable to all windows, although the content will vary from window to window.

**Tree Structure.** Structures are represented by tree diagrams, with the “root node” or highest level component at the top. Components that contain more information underneath them in the structure are indicated by a + box. Clicking on the + box will display the structure underneath the node. Similarly, if a - box is adjacent to the node, the level of detail immediately below it is already displayed; this detail can be hidden by clicking on the - box. Components that are connected to a branch of the tree without a square box are leaf nodes; they display the lowest and finest level of detail.

Right-clicking on a tree node may open a context sensitive menu.

**Component Selection.** Components can be selected (or highlighted) either singly or in groups. When selected, the views available from the View menu (or a right-click menu) will be those that can be applied to all of the selected components.

**Single component selection**

Selected by clicking on a component.

**Range selection**

Selected by highlighting the first component in the required selection and, while holding the Shift key on the keyboard, clicking on the last component. The selected range will be highlighted.

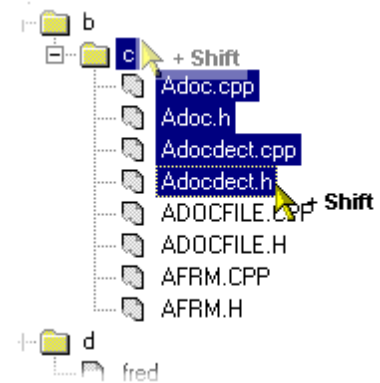

**Multiple component selection**

Selected by holding the Control key (CTRL) on the keyboard and clicking the required components.

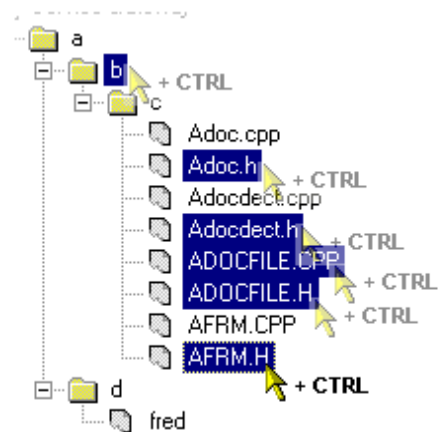

**Node selection**

Selected by holding the Alt key on the keyboard and clicking the required node; all subcomponents will be selected.

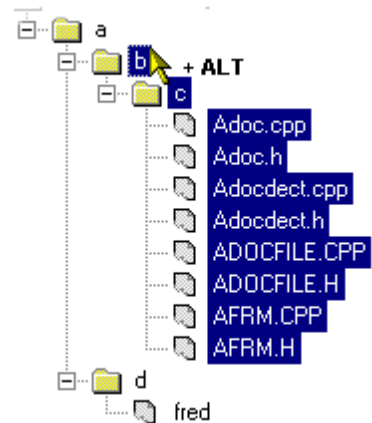

**Saving Components.** Selected (or highlighted) components can be saved through the right-click menu. However, the manner in which the components were selected (see previous paragraphs) will affect the file structure of the saved components.

If a Node Selection has been made, the directory structure is recreated at the specified location and the subcomponents are saved to their equivalent directories.

If a Range or Multiple selection has been made, all files will be duplicated in the root directory at the specified location in addition to recreating the directory structure and saving the sub-components to their equivalent directories.

**Hex Displays.** Hex displays follow a common format.

The eight-digit number in the left column is the address of the first (that is, left) byte in the row. The addresses themselves are shown in hexadecimal format.

The center column displays the contents of the structure in hex format.

The right column displays the contents of the structure in ASCII format.



# Views

The Carousel Analyzer provides three types of view as a means of inspecting and analyzing information carried in a transport stream.

## **Static Views:**

(Programs/Services, Object Carousel, U-N Download, Data Carousel, PID, Log)  
Static views display information derived from the transport stream when it is opened.

## **Structure Views:**

(Transport Packet, U-N Messages, Module, Section, BIOP Messages)  
Structure views use Tektronix scripting technology to analyze structures that appear in the transport stream, for example, tp, and BIOP messages. For repeated structures, this view allows all occurrences to be visited.

## **Chart Views:**

(Bitrate, Repetition Rate)  
Chart views present timing information in graphical form about one or more structure in the stream.







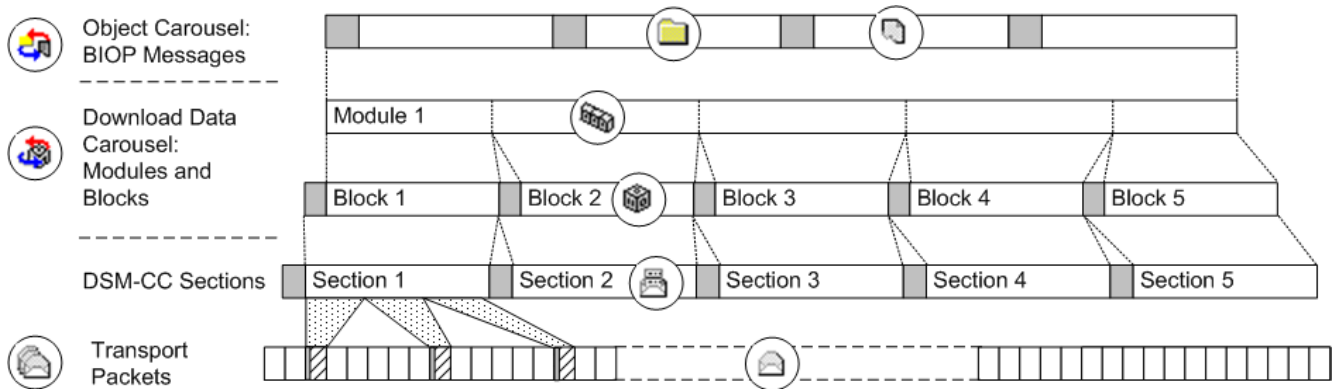













<b>View</b>	<b>Page</b>	<b>View</b>	<b>Page</b>
Programs/Services View	6-30	Structure Views	6-52
Object Carousel View	6-34	Bitrate View	6-55
U-N-Download View	6-41	Repetition View	6-58
Data Carousel (DVB) View	6-45	PID View	6-61
Data Carousel (ARIB) View	6-46	Log View	6-64
Resource View	6-50	Cycle Times View	6-67

In the following sections, each view is described together with the information accessible from that view.





The nodes displayed in the views relate to the protocol layers as shown in the diagram below:



**Table 6-10: Key to Tree Nodes**

	Service/Program		Active PIDs/PIDs
	Download Block		BIOP Object Directory / ARIB Directory
	U-N Message		BIOP Object / ARIB Resource
	Download Module		Table
	Compressed Download Module		Transport Packet
	Data Carousel		Audio Stream
	Object Carousel		Video Stream
	Stream Object		Data/Other Stream
	Stream Event Object		MHP Applications
	Java Application		HTML Application

**Key to Node Overlays.** Overlays are used to signify additional information about nodes; the overlays may be used individually or in combination.

 	<p><b>Absent Objects:</b> Objects referenced but not found, for example, directory object not found. The path in which the absent object is recognized is also marked.</p>
	<p><b>Unresolved Objects:</b> When an object is found during analysis, but its key is not referred to in the Service Gateway, it is displayed under an Unresolved Objects node.</p>
	<p><b>Boot Class Objects:</b> Boot class items are identified. The path in which the boot class resides is also indicated.</p>
	<p><b>Manual Signaling:</b> Indicates that a PID has been subjected to the manual signaling process; used in the carousel and PID views only.</p>

## Programs/Services View

**Menu Bar:** View > Program/Services

**Toolbar:**



The Programs/Services view gives a static, DVB/ARIB service (or MPEG program) centric view of the transport stream contents. Each program is listed together with the service name (for DVB/ARIB). Expanding a program item will reveal its elemental PIDs and any object (or data) carousels associated with it.

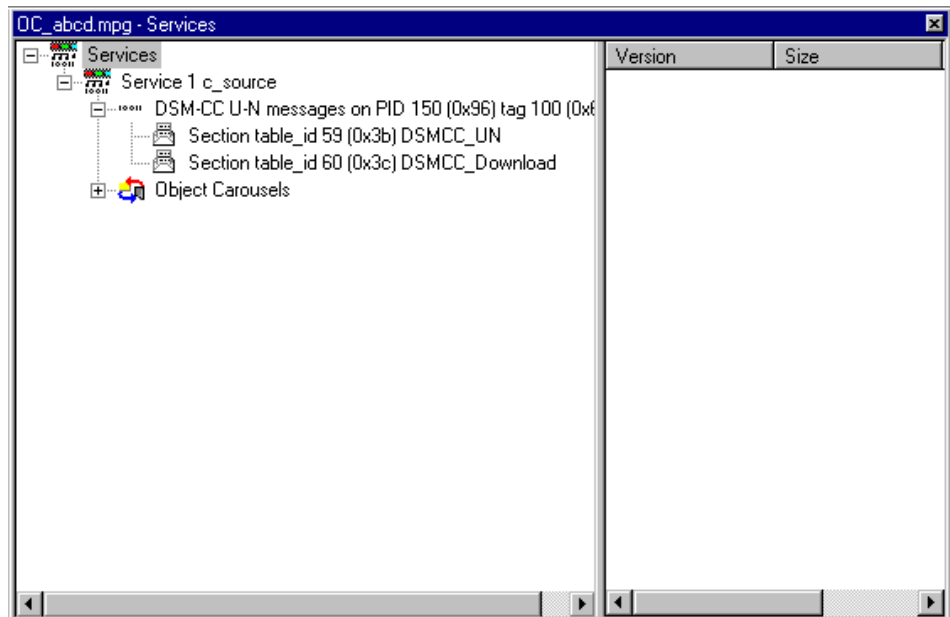

**Figure 6-2: DVB Programs/Services view (typical)**



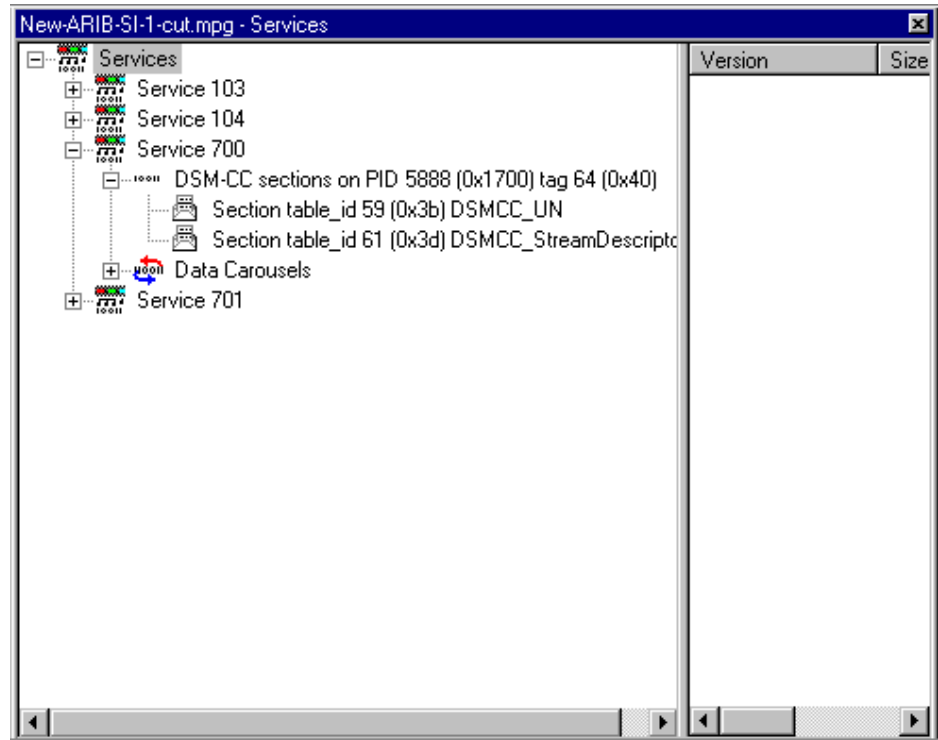

**Figure 6-3: ARIB Programs/Services view (typical)**

The diagram below indicates the primary nodes that are accessible from the Program/Services view.

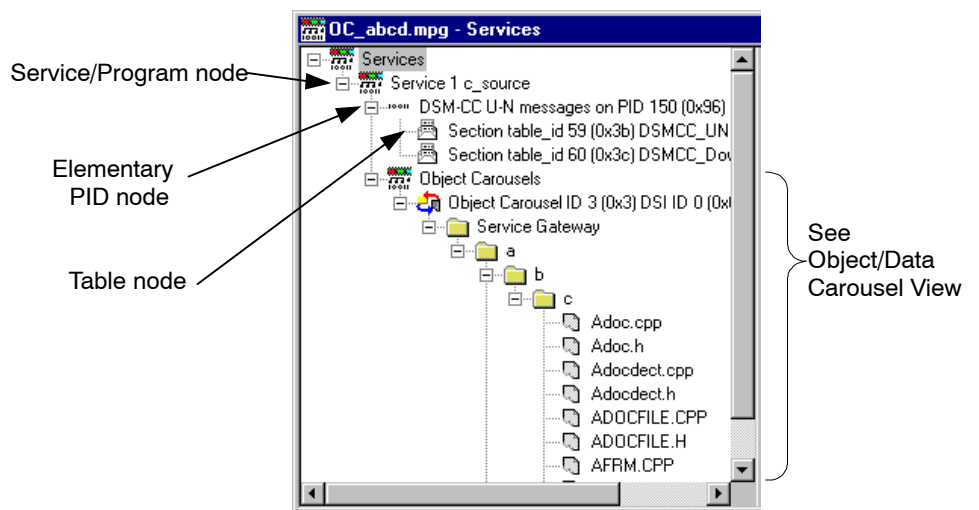

## Service/Program Node



This node represents a specific program or service (DVB or ARIB) in a transport stream. If a name for the program is available in the SDT (Service Description Table), it is displayed. Each Elementary PID listed in the PMT (Program Map Table) will have a corresponding node displayed as a child node of the Services/Program node. Similarly, any Object or Data Carousels associated with the Services/Program node are listed as child nodes.

### Right-Click Menu Options.

- View PMT**                      Opens the Section Table view for the PMT.
- View Bitrate**                Activates or creates a bit rate view of the sum of the elementary streams that are listed in the PMT for this program.

## Elementary PID Node



This node represents a PID referenced by a program. If the PID carries Sections, these are represented as Table nodes.

### Right-Click Menu Options.

- View Transport Packet**                      Displays a structure view of the next transport packet encountered on this PID from the current stream position (as indicated by the Transport Packet number that is displayed in the Transport Packet Bar).
- View Cycle Time** ►                      Allows either cycle time statistics or graphical view to be selected.
- View Repetition**                      Activates or creates a view of the repetition rate of this PID in the transport stream.
- View Bitrate**                      Activates or creates a bit rate view of this PID.

**Table Node**



This node represents the stream of sections present on a specific PID with a specific table identity.

**Right-Click Menu Options.**

- View Section**                      Displays a structure view of the next section with this PID and table identity that can be formed from the current stream position onwards (as indicated by the Transport Packet number displayed in the Transport Packet Bar).
- View Cycle Time** ►              Allows either cycle time statistics or graphical view to be selected.
- View Repetition**                  Activates or creates a view of the repetition rate of this PID with this PID and table identity.
- View Bitrate**                      Activates or creates a bit rate view of sections with this PID and table identity.

## Object Carousel View

**Menu Bar:** View > Object Carousels

**Toolbar:**



The Object Carousel view shows a static view of every object carousel in the transport stream.

The view is in the style of Windows Explorer. The left pane shows the directory structure of the object carousels, and the right pane lists the versions of the BIOP message currently selected in the left pane.

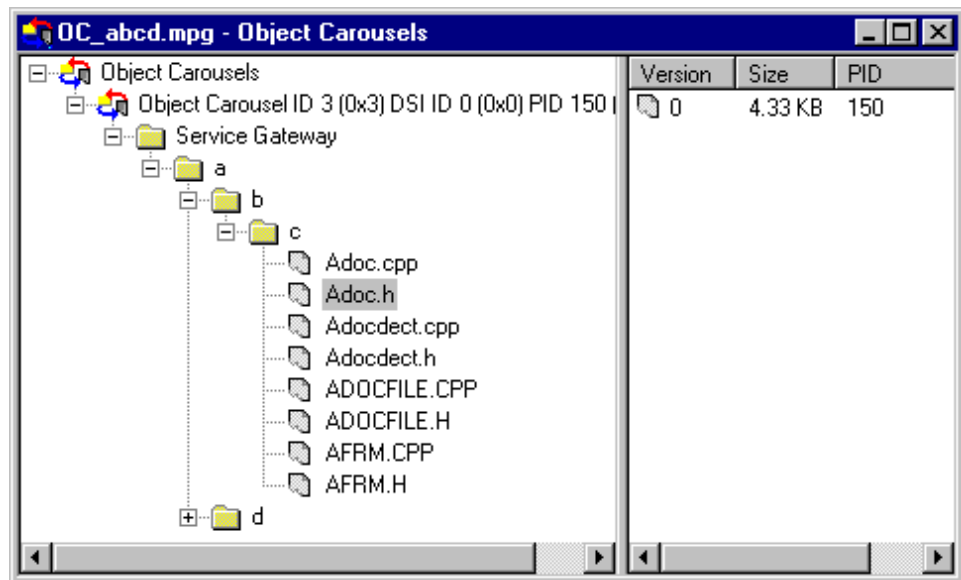

Double-clicking a file BIOP message can bring up an appropriate viewer application if the operating system can find one (file associations can be set through the Windows Explorer Options). File BIOP messages can also be saved to disk by selecting **File > Save As...**

---

**NOTE.** The version number of the BIOP messages represents the version number of the module that carries the BIOP message.

---

The following diagram indicates the nodes accessible from the Object Carousels view:

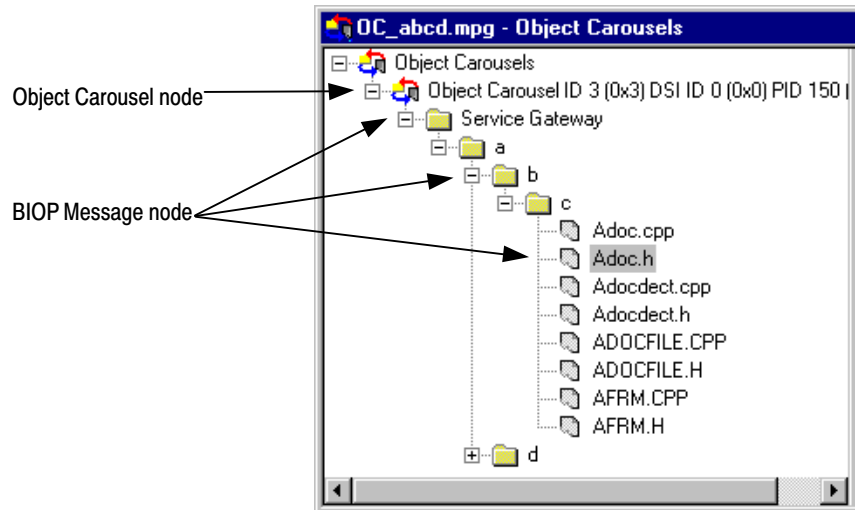

**Object Carousel node**



This node indicates that an object carousel has been signaled in the PSI/SI.

**Right-Click Menu Options.**

**View Application Timing**

Opens the Application Management dialog.

**View DSI Carrying Carousel IOR**

Displays a structure view showing the U-N DSI message that carries the service gateway IOR for this carousel.

**BIOP Message node**



This node represents a specific BIOP Message. If the node represents a BIOP directory, the directory entries appear as child nodes.

**Right-Click Menu Options.**

**Open**

View the message in its native format. This only works for file messages that have an associated viewer application on the PC.

**Save As...**

Save the BIOP message to a separate file.

**View BIOP Message**

Displays a structure view of the next appearance of this BIOP message that can be formed from the current stream position onwards (as indicated by the Transport Packet number displayed in the Transport Packet Bar).

- View Carrier Module** Activates or creates the U-N download view and highlights the module that carries this BIOP message.
- View Cycle Time** ► Allows either cycle time statistics or graphical view of the carousel to be selected.
- View Repetition** Activates or creates a view of the repetition of this BIOP message.
- View Bitrate**
  - > **This BIOP message:** Activates or creates a view of the bit rate of this BIOP message.
  - > **Including nested messages:** View the sum of the bit rates for this BIOP message and all descendant messages (that is, all children and their children). These options are only available for BIOP directory messages.

**NOTE.** If a Service Gateway is viewed in the Bitrate, Repetition, or Structure view, its name in these views reflects the DSI transaction ID and PID in which it was carried.

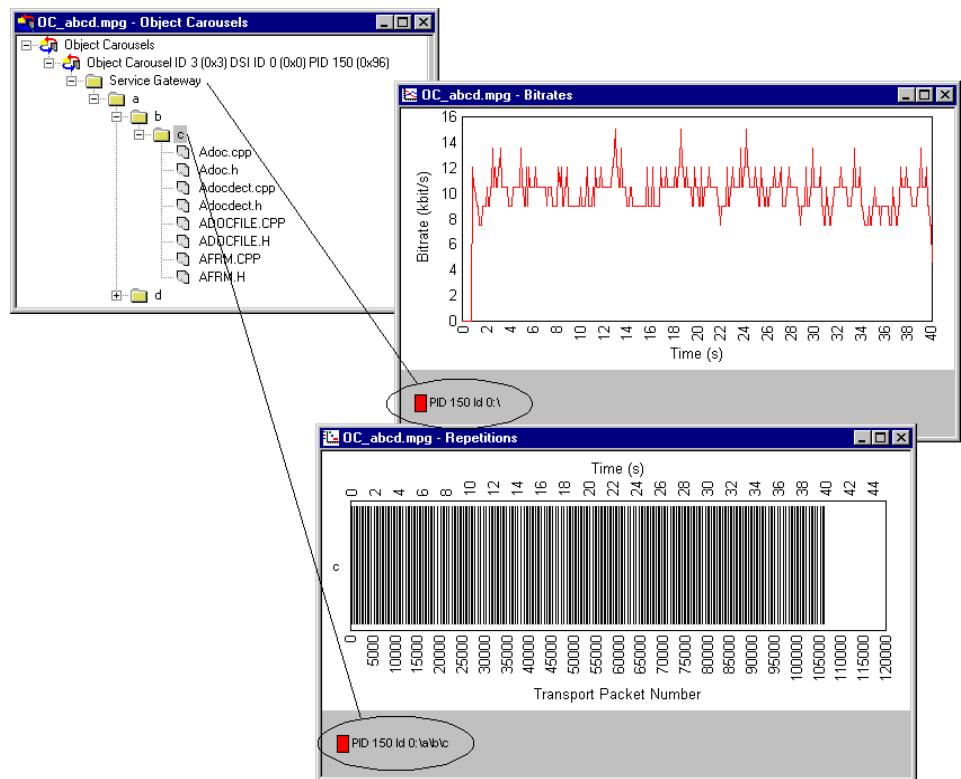

**MHP Applications** (See *MHP Support*, page 6–91.)

**Unresolved Objects** When an object is found during analysis, but its key is not referred to in the Service Gateway, it is displayed under an Unresolved Objects node.

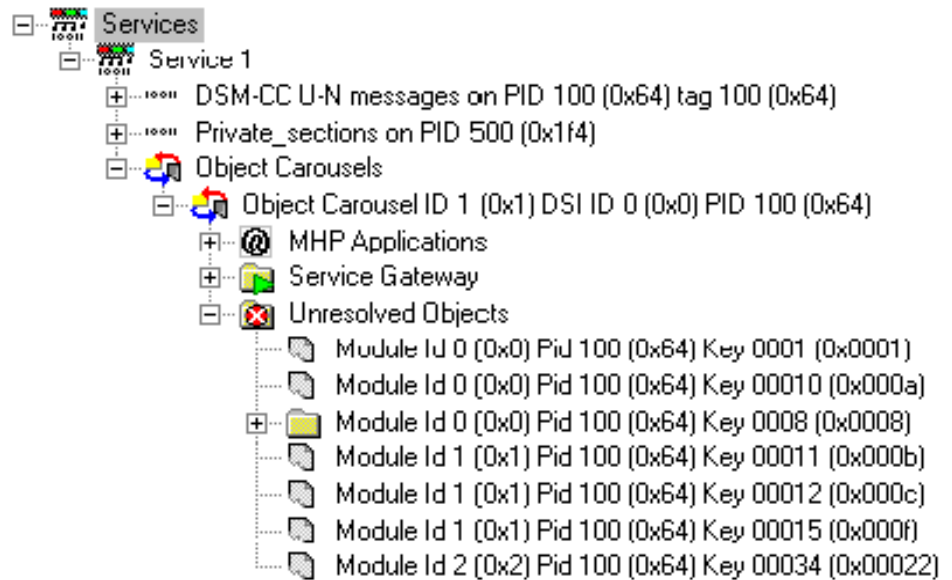

However, when a directory object is found, the keys of its child nodes can be resolved and its tree structure built correctly, even though the directory object itself may still be unresolved.

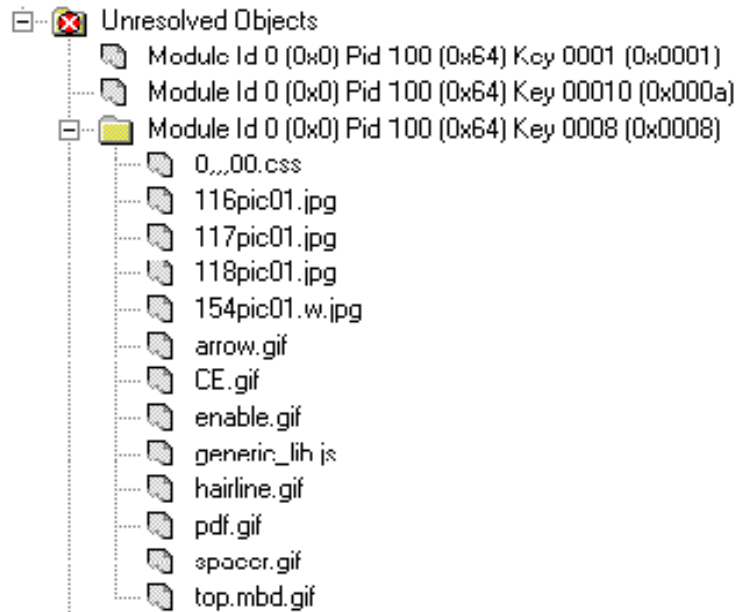

**Absent Objects**

Objects referenced but not found are identified, for example, - directory object not found. The path in which the absent object is recognized is also marked ().

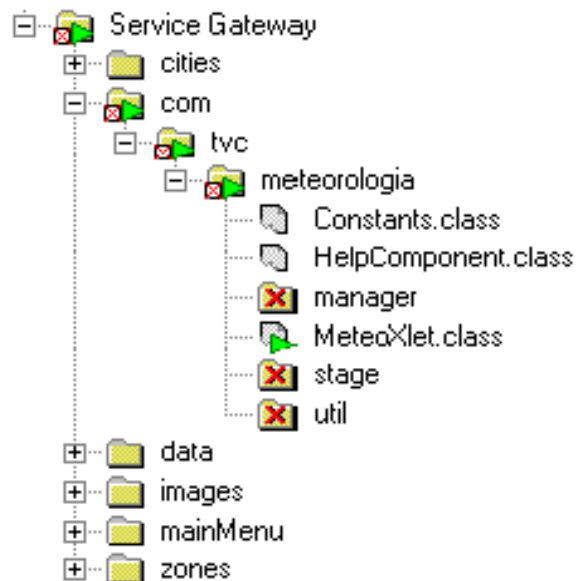



## Manual Signaling

If a carousel is present in a stream, but has not been found during analysis, it can be identified with Manual Signaling from the related PID node.

The Signal Carousel command can be found on the right-click menu associated with each PID node. When this command is selected, the stream will be reprocessed. During processing, only the DSM-CC tables on the selected PID will be analyzed.

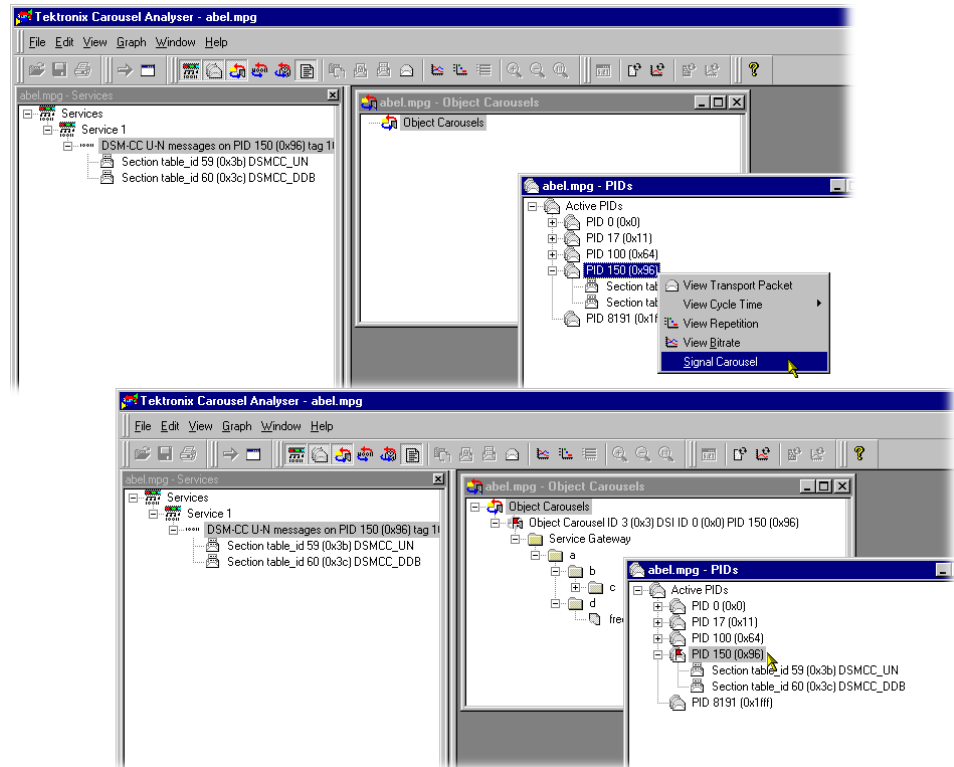

The user interface is updated when the stream has been processed. Any carousels that have been identified are added to the Carousel view. The signal icon, used only in the carousel and PID views, indicates that the PID has been subjected to the manual signaling process.

The PID view will display a list of the table types that were detected during processing.

---

**NOTE.** Carousels that span multiple PIDs will be only partially analyzed. The PID must contain a Service Gateway for any Object Carousel view to be displayed.

---

The Log view is refreshed by describing the most recent action, for example, **Added Manually Signalled PID150....**

Any feedback from the Manual Signaling will be displayed in the Summary log.

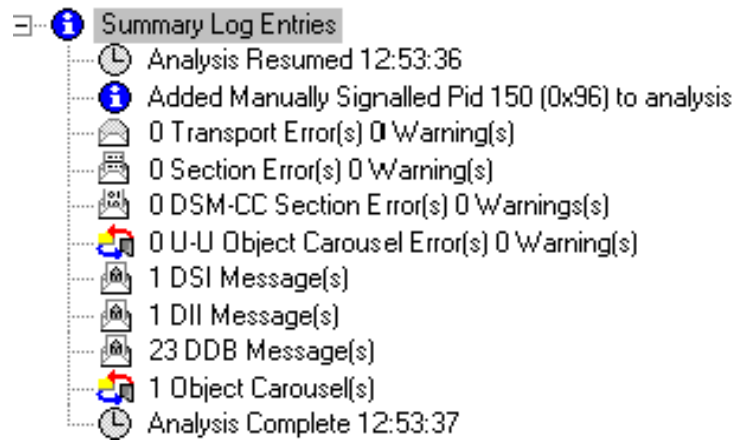

## U-N-Download View

**Menu Bar:** View > U-N-Download

**Toolbar:** 

This static view shows all the U-N-download (DSM-CC data carousel scenario) messages in the transport stream.

The view is in the style of Windows Explorer. The left pane contains a hierarchical pane on the left and a version pane on the right. The version pane will list the versions of the U-N download message selected in the left pane.

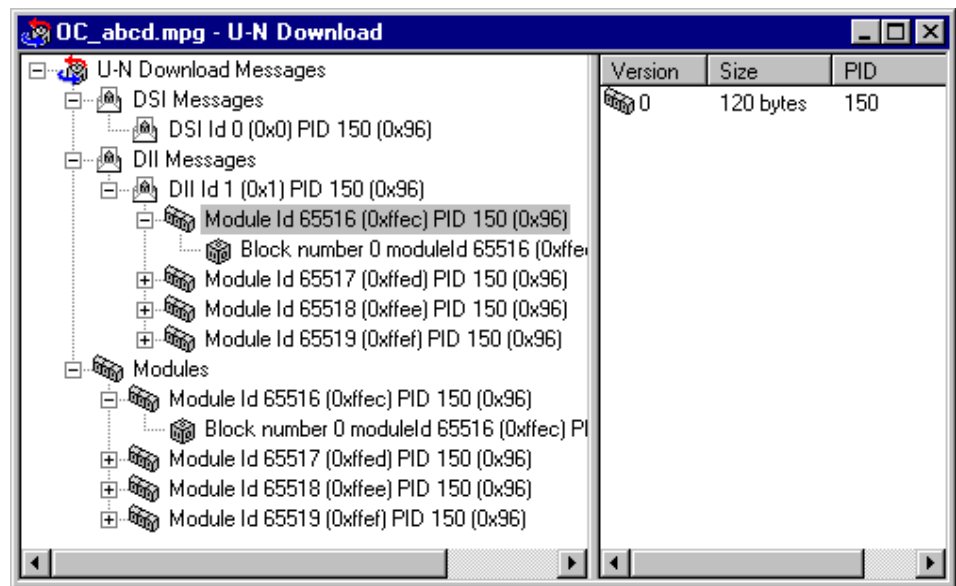

DII items contain module items that the DII message references. All modules are also listed under the “Modules” item.

Modules may be in compressed form; the version of the compressed icon is displayed in the Version column of the right pane. 

Modules are listed independently of DII messages in case the DII does not reference the module correctly; for a compliant stream, each module is listed as a child of the DII node and within the Modules node.

The following illustration indicates the nodes that are accessible from the U-N Download view.

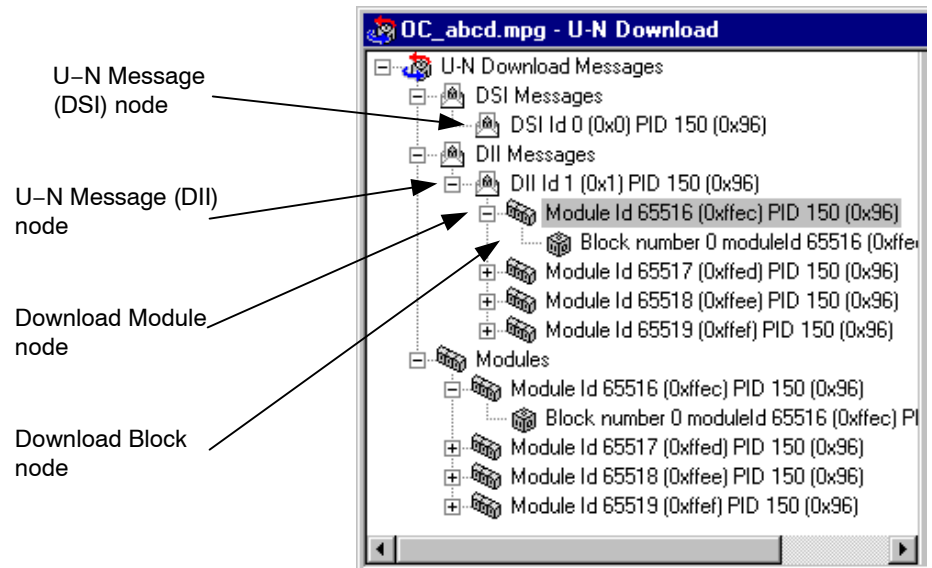

**U-N Message (DSI) node**



This node represents a Download Server Initiate message.

**Right-Click Menu Options.**

- View U-N Message**      Displays a structure view of the next appearance of this DSI message that can be formed from the current stream position onwards (as indicated by the Transport Packet number displayed in the Transport Packet Bar).
- View Carrier Section**      Displays a structure view of the next appearance of the section that carries this DSI message.
- View Cycle Time >**      Allows either cycle time statistics or graphical view of the object to be selected.
- View Repetition**      Activates or creates a repetition view of the DSI message.
- View Bitrate**      Activates or creates a bit rate view of the DSI message.

**U-N Message (DII) node**



This node represents a Download Information Indication message. A DII message may reference modules. If the module reference can be resolved, the DII tree node will contain child Module nodes.

**Right-Click Menu Options.**

- View U-N Message**      Displays a structure view of the next appearance of this DII message that can be formed from the current stream position onwards (as indicated by the Transport Packet number displayed in the Transport Packet Bar).
- View Carrier Section**      Displays a structure view of the next appearance of the section that carries this DII message.
- View Cycle Time >**      Allows either cycle time statistics or graphical view of the object to be selected.
- View Repetition**      Activates or creates a repetition view of the DII message.
- View Bitrate**      Activates or creates a bit rate view of the DII message.

**Download Module node**



This node represents a U-N Download Module. The download blocks that constitute the module are listed as child nodes.

**Right-Click Menu Options.**

- View Hex Dump**      Displays a data view of the next appearance of this module that can be formed from the current stream position onwards (as indicated by the Transport Packet number displayed in the Transport Packet Bar).
- View Cycle Time >**      Allows either cycle time statistics or graphical view of the object to be selected.
- View Repetition**      Activates or creates a repetition view of the module.
- View Bitrate**      Activates or creates a bit rate view of the module.

**Block node**  This node represents a U-N Download Data Block (DDB).

**Right-Click Menu Options.**

**View U-N Message** Displays a structure view of the next appearance of this DDB message that can be formed from the current stream position onwards (as indicated by the Transport Packet number displayed in the Transport Packet Bar).

**View Carrier Section** Displays a structure view of the next appearance of the section that carries this DDB message.

**View Cycle Time >** Allows either cycle time statistics or graphical view of the object to be selected.

**View Repetition** Activates or creates a repetition view of the DDB message.

**View Bitrate** Activates or creates a bit rate view of the DDB message.

## Data Carousel (DVB) View

**Menu Bar:** View > Data Carousel

**Toolbar:** 

This static view shows all the data carousels in the DVB transport stream. The view is in the explorer style with a hierarchical view in the left pane and a version view in the right.

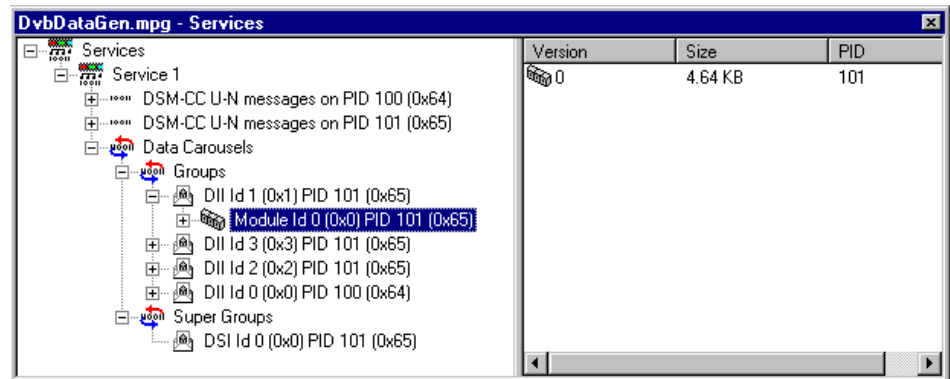

## Data Carousel (ARIB) View

**Menu Bar:** View > Data Carousel

**Toolbar:** 

This static view shows all the data carousels in the ARIB transport stream. The view is in the explorer style with a hierarchical view in the left pane and a version view in the right.

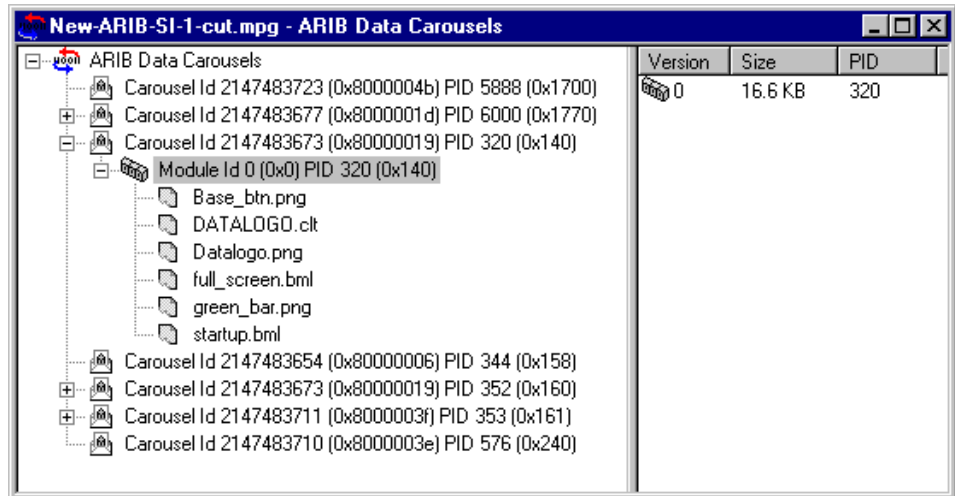

The diagram below indicates the nodes that are accessible from the Data Carousel (ARIB) view.

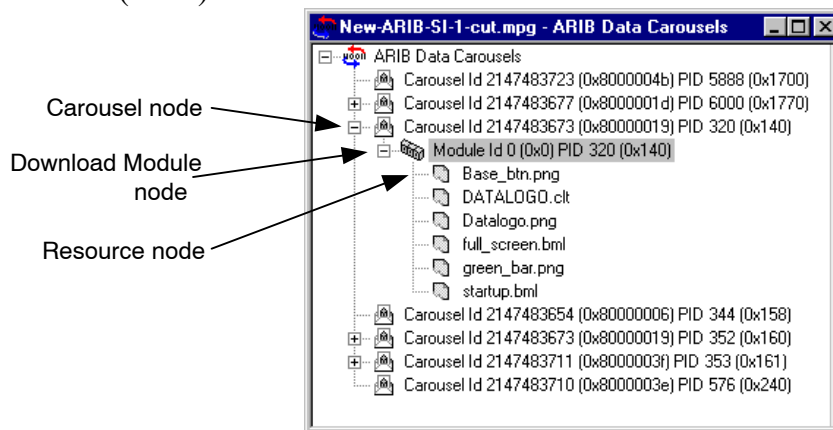



**Carousel node**



This node represents a single Data Carousel in the ARIB data carousel structure.

**Right-Click Menu Options.**

- View U-N Message**      Displays a structure view of the next appearance of this DII message that can be formed from the current stream position onwards (as indicated by the Transport Packet number displayed in the Transport Packet Bar).
- View Carrier Section**      Displays a structure view of the next appearance of the section that carries this DII message.
- View Cycle Time >**      Allows either cycle time statistics or graphical view of the object to be selected.
- View Repetition**      Activates or creates a repetition view of the DII message.
- View Bitrate**      Activates or creates a bit rate view of the DII message.

**Download Module node**



This node contains all of the resources available to a module.

**Right-Click Menu Options.**

- View Resources**      Displays the Resource view of the selected module.
- Save Resources**      Saves the resource files to a selected location. The header information is not saved.
- View Cycle Time >**      Allows either cycle time statistics or graphical view of the object to be selected.
- View Repetition**      Activates or creates a repetition view of the module.
- View Bitrate**      Activates or creates a bit rate view of the module.

(See also *ARIB Module Versions*, page 6–49.)

**Resource node**



Each Resource node is a leaf node containing one resource file.

**Right-Click Menu Options.**

- |             |  |
|-------------|--|
| <b>Open</b> | Opens the resource in an associated application to allow it to be viewed. If no association has been made with the file type on the host computer, a message is displayed. |
| <b>Save</b> | Saves the resource file to a selected location. The header information is not saved.   |
| <b>View</b> | Displays the Resource view. The selected resource is highlighted in the Resource view.   |

### ARIB Module Versions

Note that there may be multiple versions of a single ARIB module. Each version of the same module can potentially contain different resources. For example, Version 1 may contain resources A, B, and C and Version 2 may contain resources C, D, and E.

When viewing the resources in Data Carousel and Service/Program views, the resources listed under the Module node will be all resources across all versions, for example, A, B, C, D and E. When opening or saving any of these resources from Data Carousel or Service/Program views, the operation will work on the first version encountered in the stream (A, B, and C will come from Version 1 and D and E will come from Version 2). Basically, these two views contain a summary of all the resources encountered in that module regardless of version.

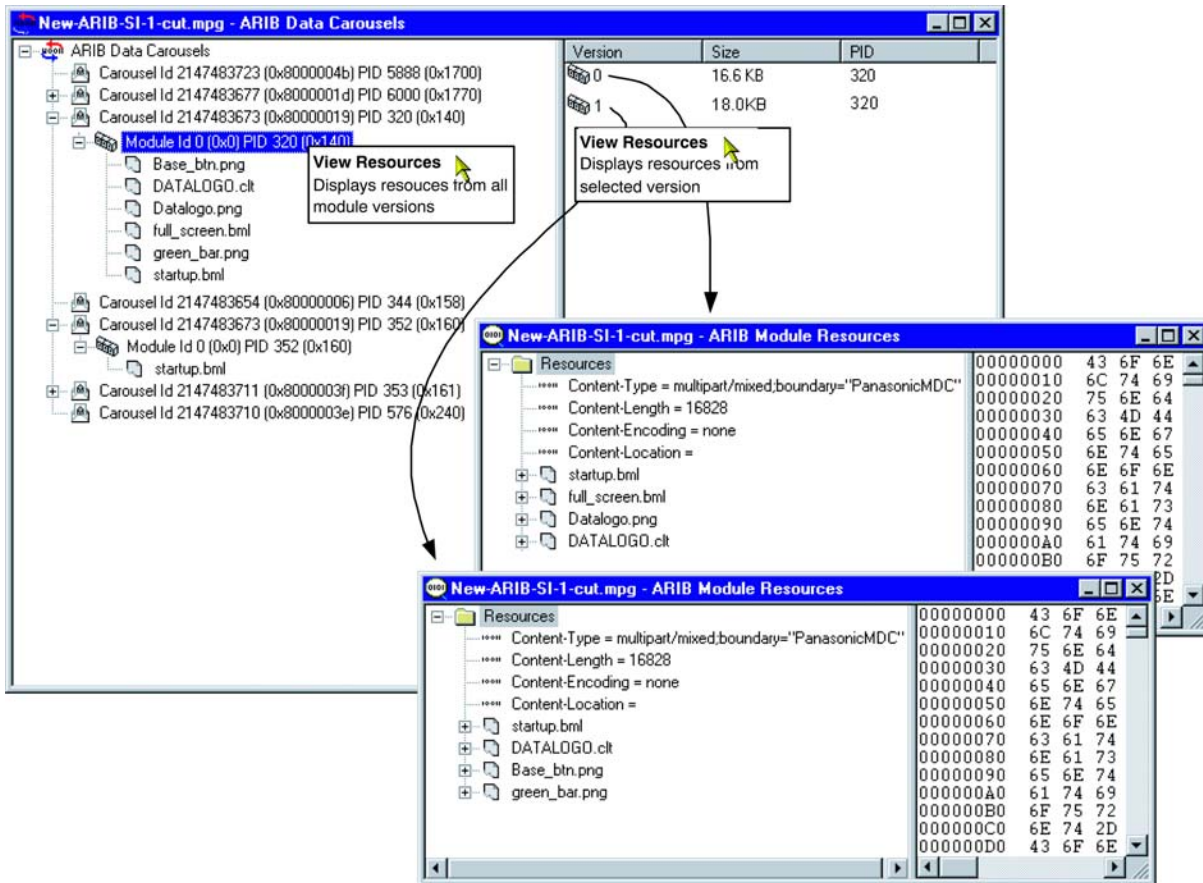

The ARIB Resource view will show only the resources contained in an individual module version - to view resources from different module versions, the user must use the **Go To Next** command or open a different version in ARIB Resource view.

## Resource View

**Menu Bar:** View > Resources

The ARIB Resources view displays a hierarchical and raw data interpretation of the resource structure in Data Carousels. The raw data is presented in hexadecimal and ASCII form in the adjacent pane.

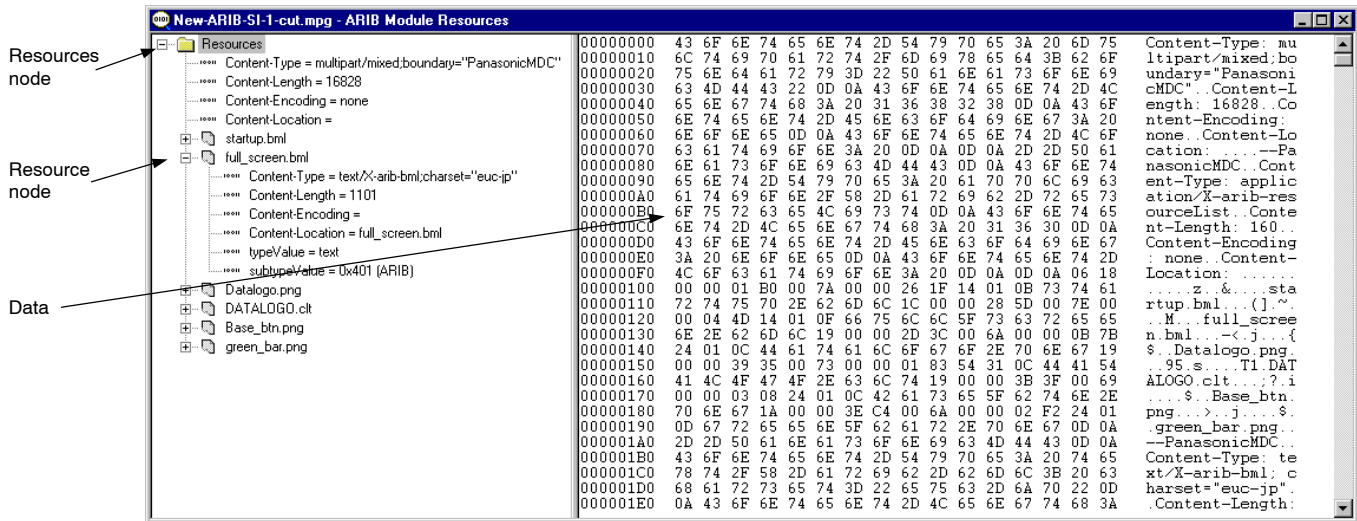

### Resources node

 This Resources node displays a header and the resources associated with one Module.

### Right-Click Menu Options.

 **Go To Next** Displays the next occurrence of the Resource node in the transport stream (note the change of **Packet** number in the Status bar).

**Save** Saves the resource files to a selected location. The header information is not saved.

**Resource node**



Each Resource node displays header information and a resource.

**Right-Click Menu Options.**

**Open**

Opens the resource in an associated application to allow it to be viewed. If no association has been made with the file type on the host computer, a message is displayed.

**Save**

Saves the resource file to a selected location. The header information is not saved.

**Data**

Represents the currently selected tree node.

**Right-Click Menu Options.**



**Save As...**

Saves the Module Resource data to a selected location.



**Go To Next**

Displays the next occurrence of the Resource node in the transport stream (Note the change of **Packet** number in the Status bar).

**View Transport Packet List**

Displays the **Transport Packet Contributions** view which lists the transport packets that have contributed to the resources in the module (See *Structure Views*, page 6–52).

## Structure Views

Structure views display a hierarchical and raw data interpretation of a structure (BIOP Message, U-N Message, Module, Section, or Transport Packet). The hierarchical view is based on a script from the script files that are loaded (see *Script Selection and Manipulation*, page 6–6). Raw data is presented in hexadecimal and ASCII format in the lower pane.

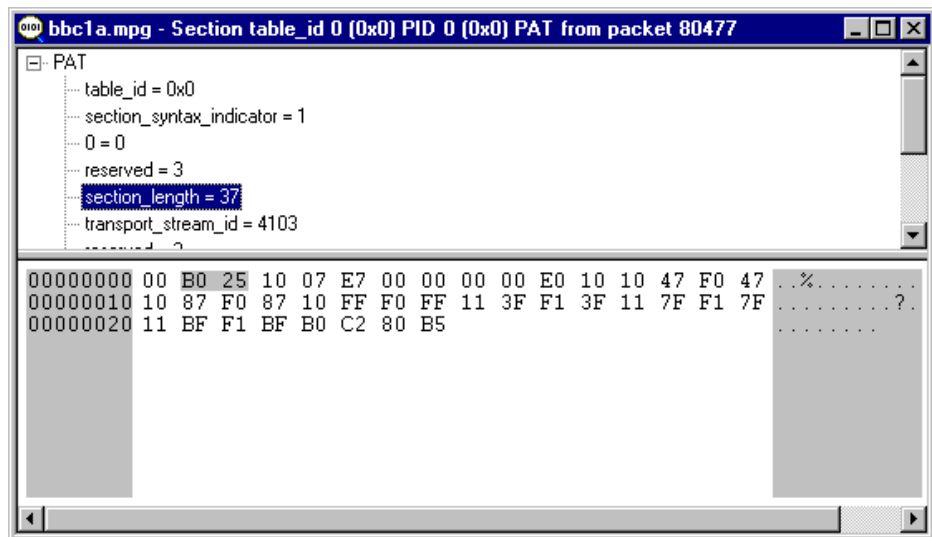

Highlighting an element in the table window will automatically highlight the section of the hexadecimal code that contains the selected information.

The view will bring up the first appearance of a particular message in the transport stream reading from the current packet position. To view the next appearance, select **Edit > Go to Next**. This will display the next repetition of the message in the open structure view window; if necessary, it will wrap to the first occurrence.

For example, in the screenshot below, the PAT first appears in transport packet 0. Selecting **Go to Next** and viewing the section again will show the next repetition of the PAT on transport packet 532 and so on.

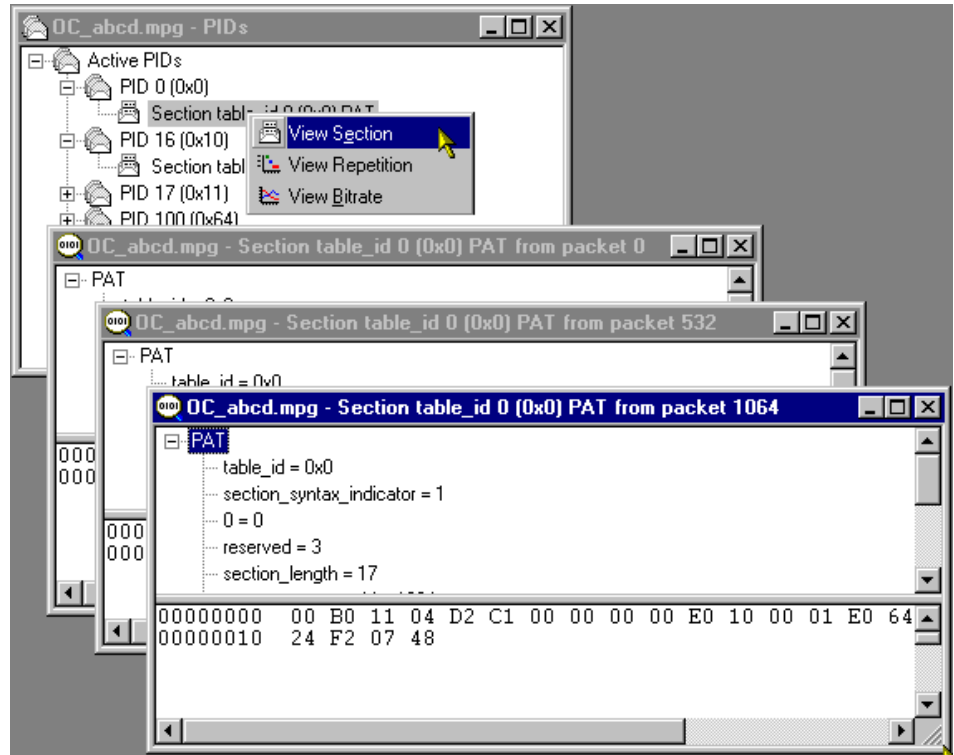

Since the structure view is based on a script, the script can be edited and the presentation of the packet or message changed.

Right-clicking on the any item in the structure view will open this menu:

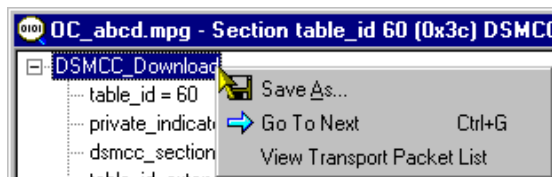

Using the **Save As...** option, the structure can be saved to a separate file.

The **Go To Next** option moves the structure view to the next repetition of the same item. If the current view is the last in the stream, the option will loop back to the first repetition in the stream.

The information displayed by the structure view may be carried in one or more transport packets. By right-clicking the item and selecting **View Transport Packet List**, a list of the transport packets carrying the information will be displayed. Highlighting a **Packet Number** and selecting **View** will display the selected transport packet structure. Several structure views can be opened in this way but the views are not enabled until the **Transport Packet Contributions** dialog is closed.

The Low and High Index entries in the **Transport Packet Contributions** dialog indicate the first and last byte respectively of the packet that contributes to the structure.

The screenshots below illustrate an example of this sequence of actions:

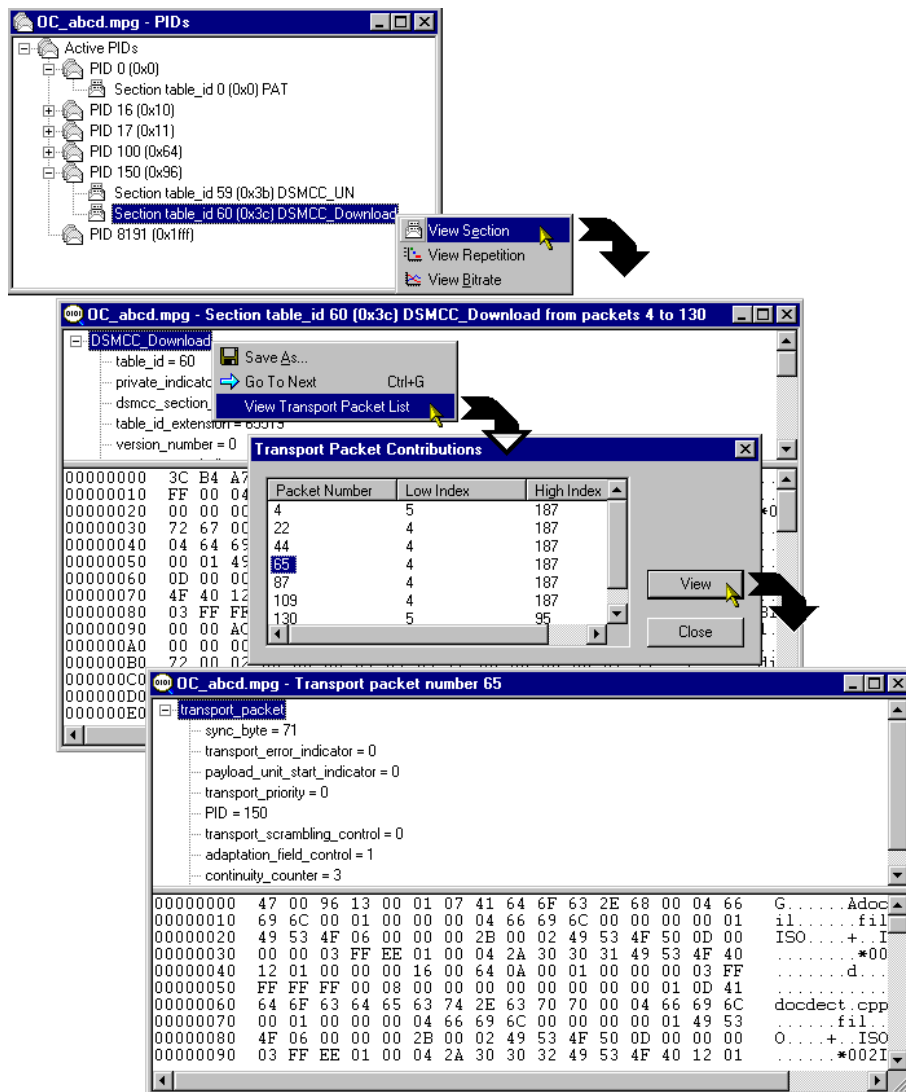



## Bitrate View

**Menu Bar:** View > Bitrate

**Toolbar:** 

This structure view charts the bit rate of a set of transport entities (for example, BIOP message, PID, module). The bit rate calculation is a rolling average. For any transport entity the sum of the transport packets that contribute to that entity in each 100 ms time-slice are summed. The average is calculated every 100 ms using the last 10 time-slices (that is, the bit rate is the average over the last second).

In some cases a choice is offered between displaying the bit rate of the selected element or a composite bit rate of the selected element and its subsidiary (nested) elements.

---

**NOTE.** In calculating bit rates, Carousel Analyzer returns to the stream file. For large files, the calculation may take an appreciable amount of time.

---

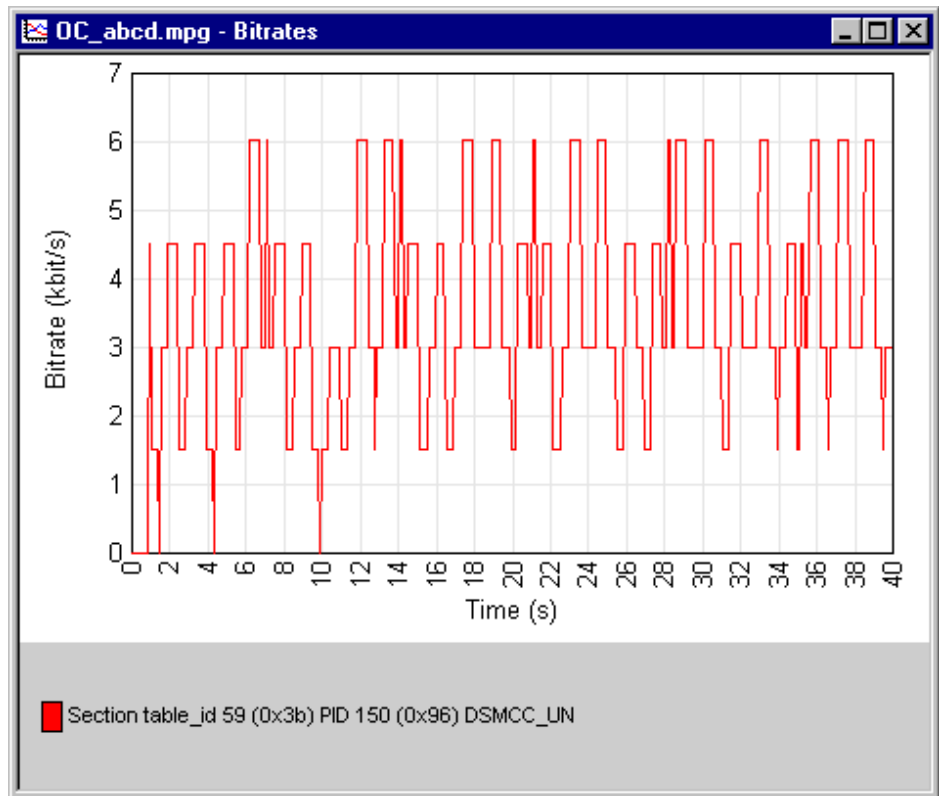

The y-axis is automatically scaled to accommodate the maximum bit rate. The name of the element from which the bit rate is derived and the related graph are linked by color; a line (of the same color) is displayed to the right of the element name.

If the bit rate for a second element is requested, it is displayed on the same graph, as shown in the following illustration:

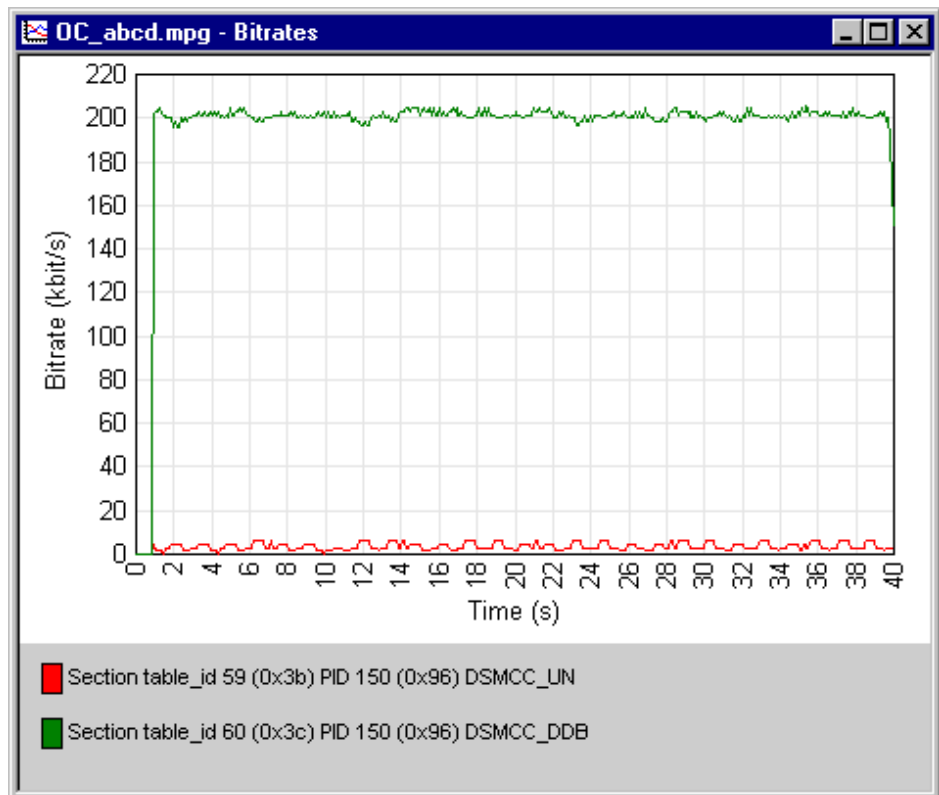

Any number of element bit rates can be displayed; each will be a separate color.

### Inspecting Bitrates

It is possible to zoom in on an area of the graph in order to inspect the bit rate in detail.

To zoom in on the central 50% of the displayed graph, use the **Graph > Zoom > Zoom In** menu option (or the Toolbar button: ; or tab key). This action can be repeated.

To zoom in on any area of the bit rate graph, drag the mouse while holding the left-button, to highlight the area required. When the mouse button is released, the highlighted area will be enlarged to fill the graph area.

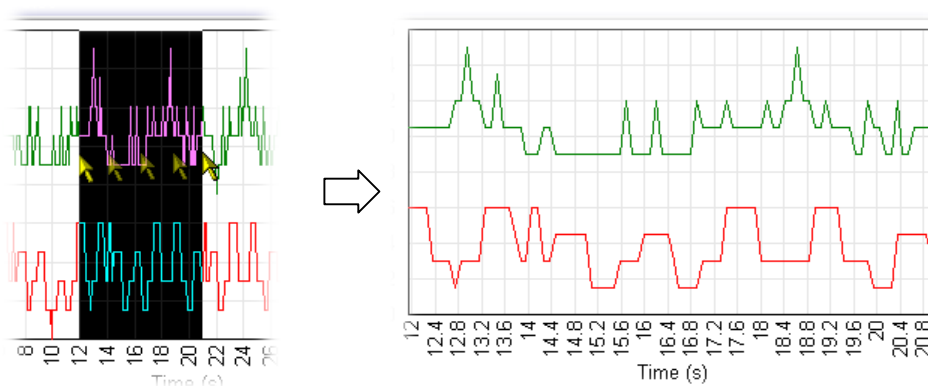

The menu option **Graph > Zoom > Zoom Out** (Toolbar: ; or shift-tab key) will zoom out one step at a time; a step being the previous zoom in actions.

The menu option **Graph > Zoom > Show All** (Toolbar: ) will redisplay the graph with no zoom factor applied.

### Saving/Copying

The graph can be saved or copied in text format or as a picture file (JPEG or bitmap).

Menu Option	Description
<b>Graph &gt; Save</b>	Save the graph to a user defined location.
<b>&gt; Bitmap</b>	Size the graph window before saving.
<b>&gt; JPEG</b>	Size the graph window before saving.
<b>&gt; Table</b>	Tab delimited format.
<b>Graph &gt; Copy</b>	Copy to clipboard, from where it can be pasted into a suitable application:
<b>&gt; Image</b>	
<b>&gt; Table</b>	Tab delimited format.

## Repetition View

**Menu Bar:** View > Repetition

**Toolbar:**



This structure view charts the repetition of a set of data broadcast entities. This Gantt style graph displays a row for each transport entity (for example, BIOP message, U-N message etc) selected. A colored block on the row indicates the presence of the message at that point in the transport stream.

**NOTE.** In calculating repetition rates, Carousel Analyzer returns to the stream file. For large files, the calculation may take an appreciable amount of time.

### Inspecting Repetition Rates

It is possible to zoom in on an area of the graph in order to inspect the repetition rate in detail.

To zoom in on the central 50% of the displayed graph, use the **View > Zoom > Zoom In** menu option (or the Toolbar button). This action can be repeated.

To zoom in on any area of the repetition rate graph, drag the mouse while holding the left-button, to highlight the area required. When the mouse button is released, the highlighted area will be enlarged to fill the graph area.

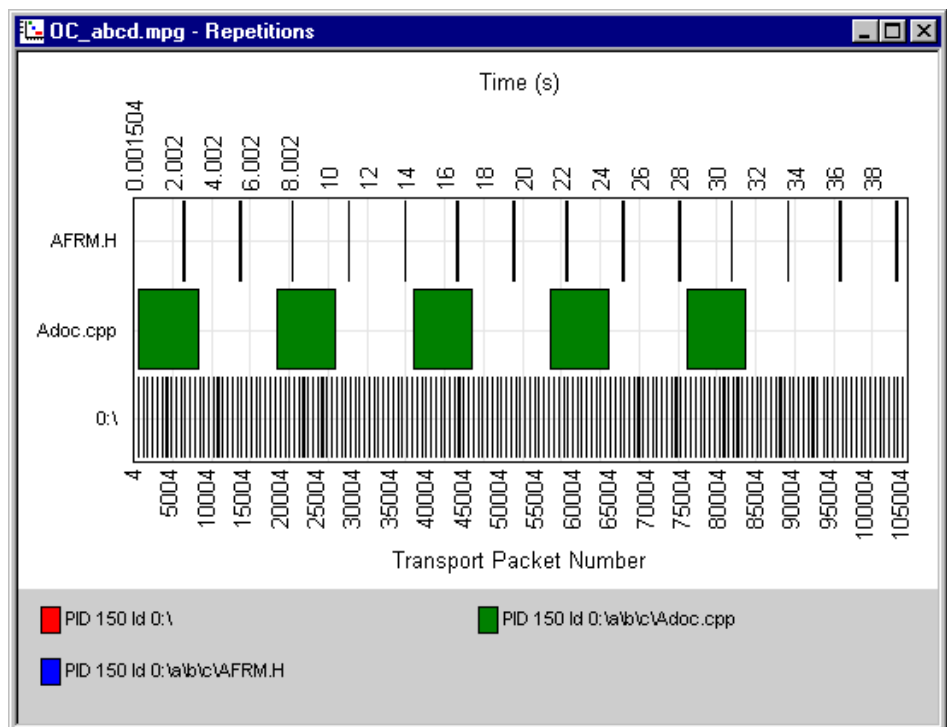

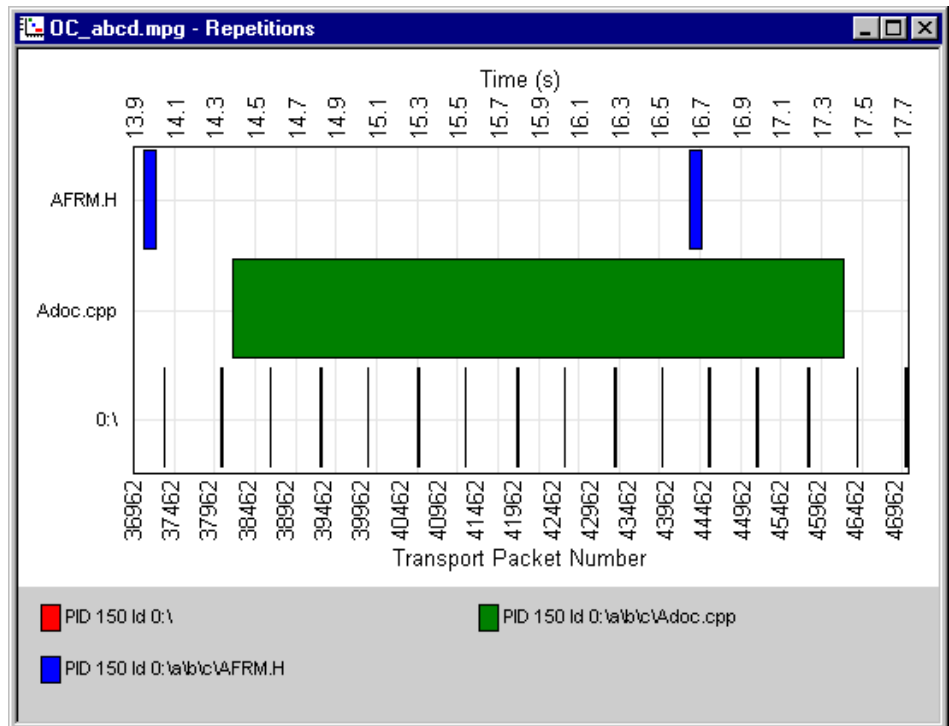
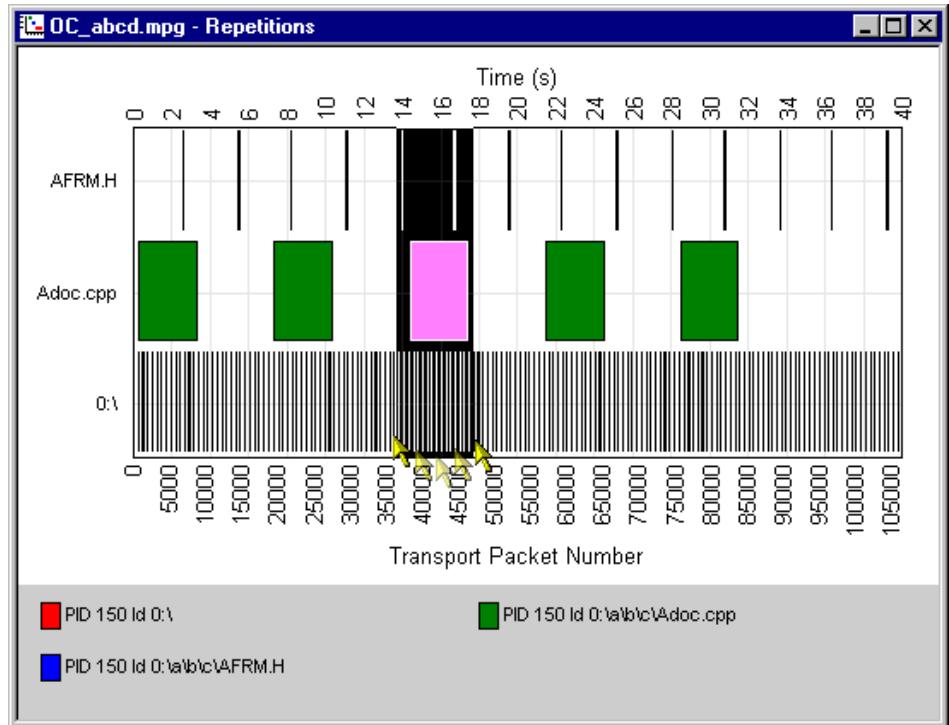

The **View > Zoom > Zoom Out** menu option (Toolbar:  or shift-tab key) will zoom out one step at a time; a step being the previous zoom in actions.

The **View > Zoom > Show All** menu option (Toolbar: ) will redisplay the graph with no zoom factor applied.

Tooltips: When the cursor is placed over a block, a tooltip provides the PID, time, and packet number.

### Saving/Copying

The graph can be saved or copied in text format or as a picture file (JPEG or bitmap).

Menu Option	Description
<b>Graph &gt; Save</b>	Save the graph to a user defined location.
> <b>Bitmap</b>	Size the graph window before saving.
> <b>JPEG</b>	Size the graph window before saving.
> <b>Table</b>	Tab delimited format.
<b>Graph &gt; Copy</b>	Copy to clipboard, from where it can be pasted into a suitable application.
> <b>Image</b>	Copy image.
> <b>Table</b>	Tab delimited format.

## PID View

**Menu Bar:** View > PIDs

**Toolbar:** 

This static view displays all the active PIDs within the transport stream. A PID carrying sections will have nested items, which detail the table types on that PID. The structure, bit rate, and repetition of transport packets and sections are available from this view.

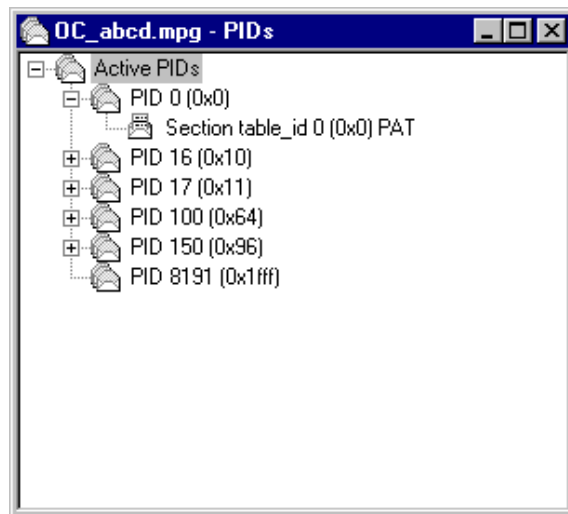

The following diagram indicates the nodes accessible from the PIDs view.

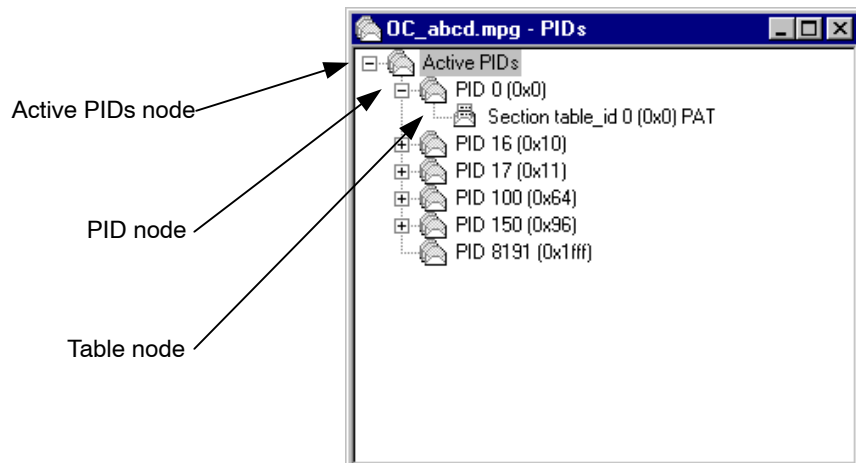

**Active PIDs node**



This node represents all the PIDs found in the current transport stream; the PIDs are listed as child items.

**Right-Click Menu Options.**

**View Transport Packet**

Displays a structure view of the packet at the current stream position (as indicated by the Transport Packet number displayed in the Transport Packet Bar).

**PID node**



Represents all the transport packets with a particular PID. If the PID carries sections then the PID tree node will have child table tree nodes.

**Right-Click Menu Options.**

**View Transport Packet**

Displays a structure view of the next transport packet encountered on this PID from the current stream position (as indicated by the Transport Packet number displayed in the Transport Packet Bar).

**View Cycle Time >**

Allows either cycle time statistics or graphical view to be selected.

**View Repetition**

Activates or creates a view of the repetition of this PID in the transport stream.

**View Bitrate**

Activates or creates a view of the bit rate of this PID.



**Table node**



This node represents the stream of sections present on a specific PID with a specific table identity.

**Right-Click Menu Options.**

- View Section**                      Displays a structure view of the next section with this PID and table identity that can be formed from the current stream position onwards (as indicated by the Transport Packet number displayed in the Transport Packet Bar).
- View Cycle Time >**              Allows either cycle time statistics or graphical view to be selected.
- View Repetition**                   Activates or creates a view of the repetition rate of this PID with this PID and table identity.
- View Bitrate**                        Activates or creates a bit rate view of sections with this PID and table identity.
- Signal Carousel**                    (See *Manual Signaling*, page 6–39.)

## Log View

**Menu Bar:** View > Log

**Toolbar:**



The log view is a tabbed window with each tab representing information about a particular MPEG-2 layer. Each tab contains any miscellaneous information about the transport stream that has been analyzed. For example, packets that have the transport\_error\_bit set will have an entry in the transport log tab.

The diagram below indicates the information that is accessible from the Log view.

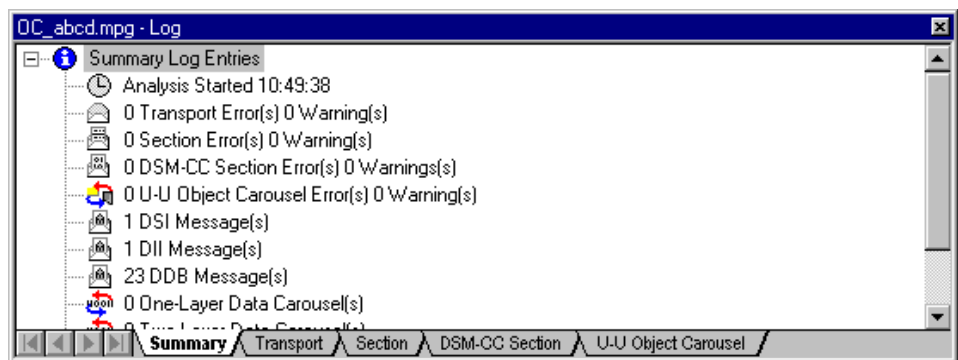

**Summary** This view provides a summary of the transport stream analysis.

**Transport Packet Log view**



This view displays the errors that have been logged in transport packets during analysis of the stream.

**Right-Click Menu Options.**

**View Transport Packet**

Displays a structure view of the highlighted transport packet.

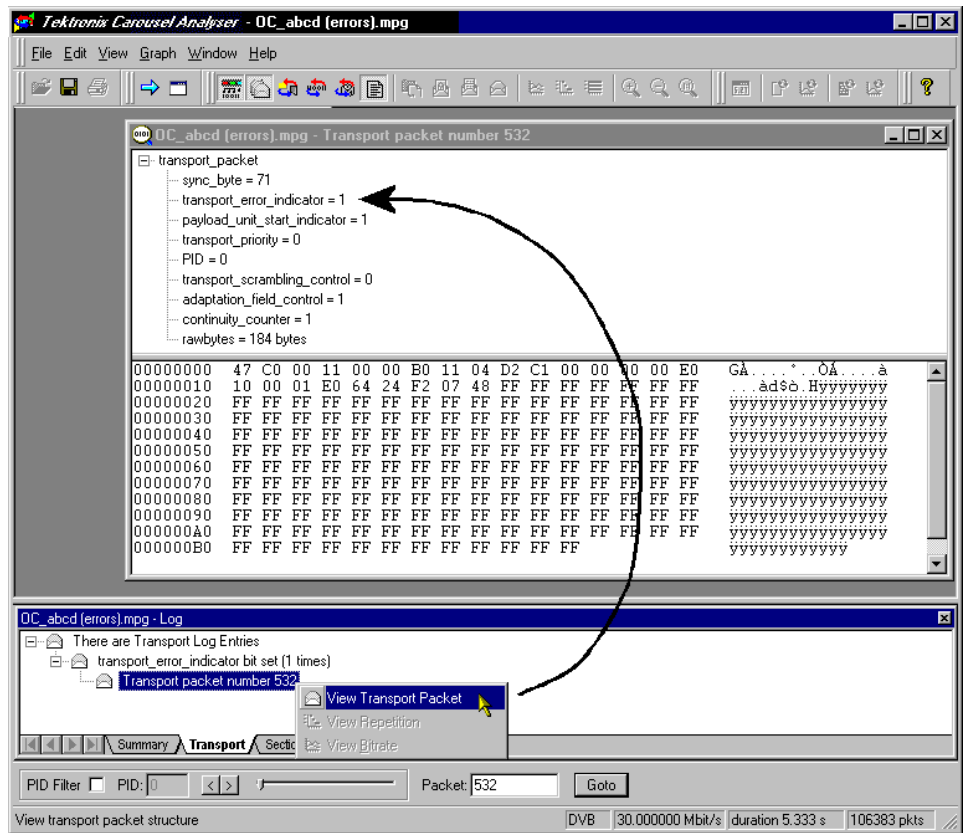

**Section Log view**



This view displays the errors that have been logged in sections during analysis of the stream.

**Right-Click Menu Options.**

**View Section**                      Displays a view of the highlighted section.

**DSM-CC Section Log view**

This view displays the errors that have been logged in DSM-CC sections during analysis of the stream.

**Right-Click Menu Options.**

**View Section**                      Displays a view of the highlighted DSM-CC section.

**U-U Object Carousel**

This view displays the warnings that have been logged in U-U Object sections during analysis of the stream.

## Cycle Times View

Cycle times can be calculated for either a carousel (given a starting point) or an entity in the transport stream.

In the following diagram, a carousel is shown carrying objects A, B and C.

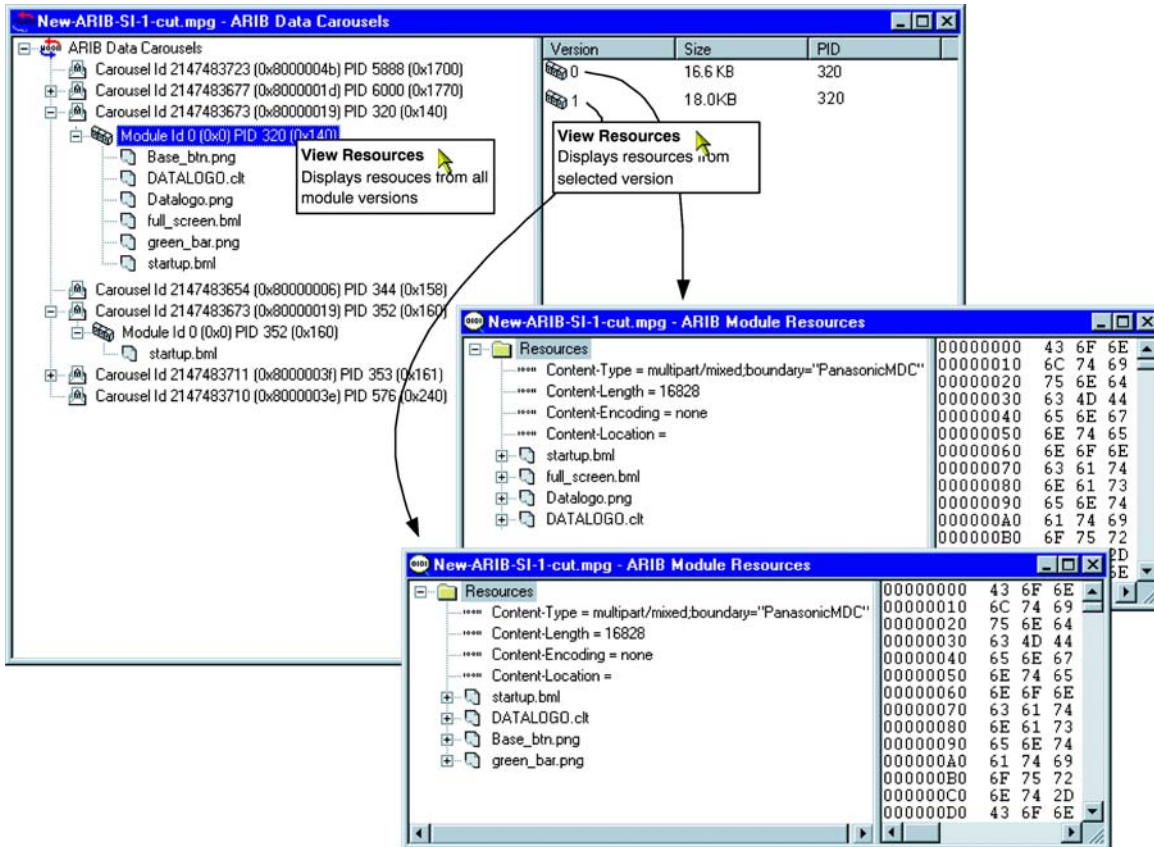

In this example, object B is identified as the starting point for both carousel and entity cycle timing. The cycle time of a carousel is the time taken to receive all of the objects within the carousel given a specified starting point in the carousel. The cycle time of any given entity in the transport stream (including Section, BIOP Object, PID and U-N Message) is the time taken from the start of an instance to the start of the next instance.

The cycle times calculated give the maximum, minimum and mean times for the occurrences of an object in a transport stream in seconds; standard deviation and number of cycles found will also be displayed. The statistics can also displayed in graphical format.

### Carousel Cycle Times Statistics

The cycle time of an object carousel is the time taken for all components of the carousel to be received starting with a selected component of the carousel.

Selecting one or more BIOP objects from a carousel and **View Carousel Cycle Time** from the right-click menu generates the **Carousel Cycle Times** statistics window. The information can also be displayed in graphical form by selecting **View Carousel Cycle Time Graph**.

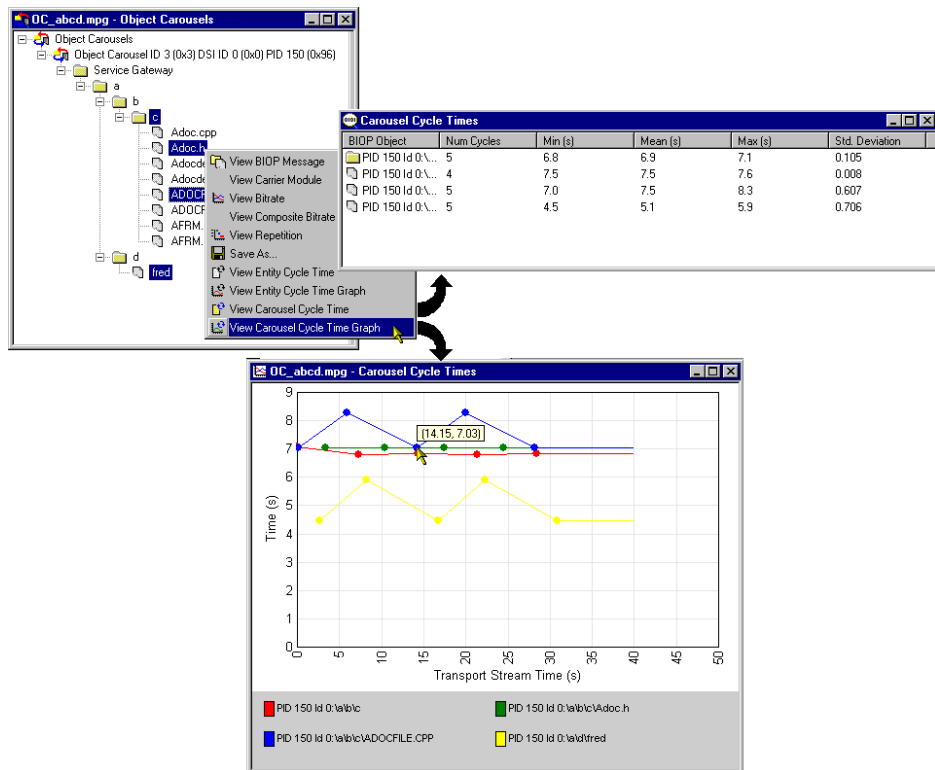

In the Carousel Cycle Times window, the BIOP Object column identifies the PID, Carousel ID and Object that the user identified as a starting point for the test.

The information can also be displayed in graphical form.

## Entity Cycle Times Statistics

Similarly, the cycle time of any entity (object) in the transport stream is the time between the start of an instance of the entity and the start of the next instance.

Selecting one or more entities in any view and **View Entity Cycle Time** from the right-click menu generates the **Entity Cycle Times** statistics window. The information can also be displayed in graphical form by selecting **View Entity Cycle Time Graph**.

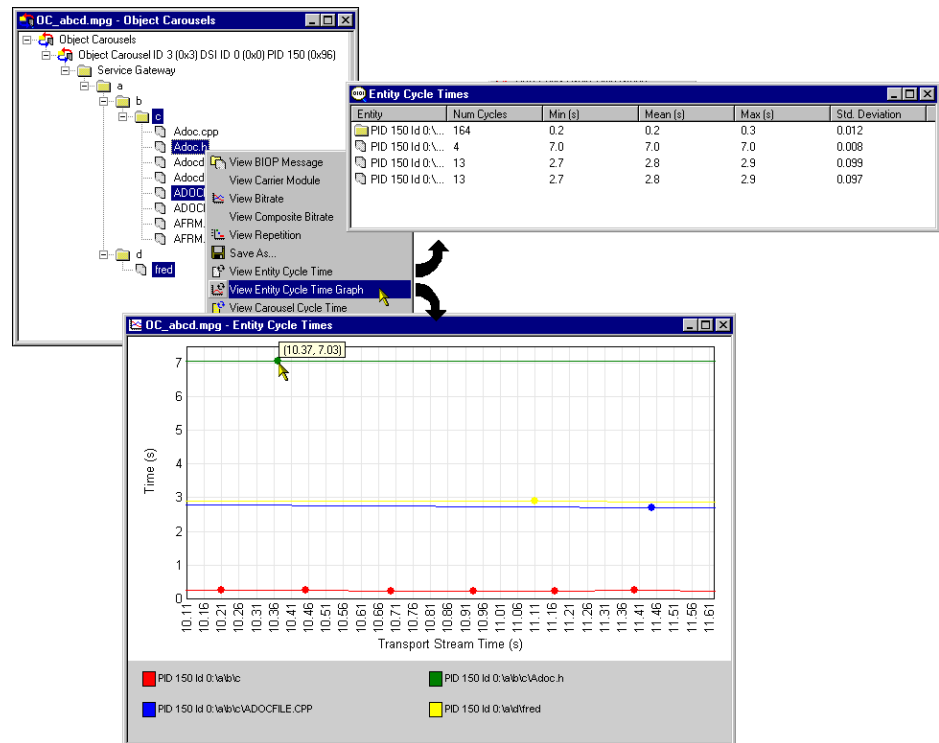

The Entity column identifies the PID, Carousel ID and Object that the user identified as a starting point for the test.

In both Carousel and Entity statistics windows, further cycle time statistics will be added to the bottom of the list while the window remains active.

Similarly, with one or more entries in a **Cycle Times** window selected, the right-click menu allows the user to display a graph of the cycle times or export cycle time statistics to a text file.





# Application Support

Carousel Analyzer provides a means of testing the effects of associating applications with Object Carousels. An application consists of a “boot class” and “assets”. Typically, a boot class will comprise a Java or HTML class; assets may be images or text required by the boot class.

A comprehensive range of tests and measurements is provided in addition to application management tools.

A single Object Carousel may be timed with several applications in the Carousel Analyzer.

## Application Management

The Application management dialog shows the applications currently defined and allows the user to manage them. The user can also create new applications.

When defining an application, it may be done by adding application tree nodes manually using context menus, or by moving parts of currently available object carousels over to the application. It is also possible to move over sub-trees from the hard disk to the application definition.

If an asset is specified as a wildcard, the timing will wait for that asset and all child assets that are found in the transport stream. This means that a directory can be specified as a wildcard asset and any content found underneath it in the transport stream will be treated as an asset, for example, specify `\bin\start-up.class` as the boot class, and `\images\` as a wildcard directory asset. Any content in the `\images\` directory in the carousel will be treated as an asset.

To open the **Applications** management dialog, select **Edit > Applications...**. The following dialog box is displayed:

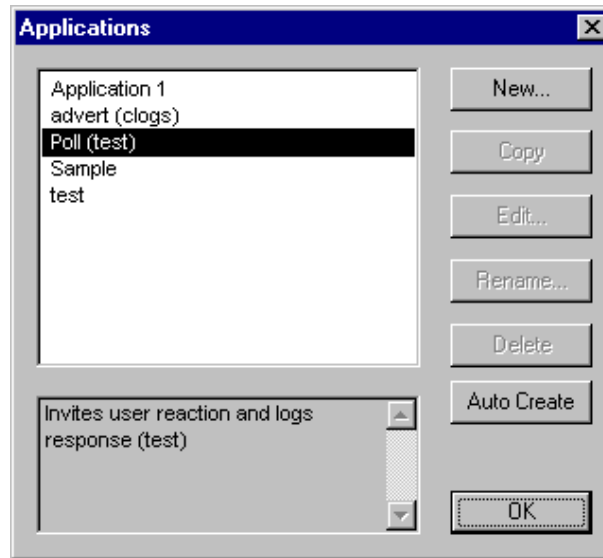

In the Applications management dialog, the main list displays those applications that have already been created. Application data is stored locally in the file C:\Program Files\Tektronix\DataTestSystem\applications.dat; this is the installation directory but it may have been modified by the user. This data file can be copied to other Carousel Analyzer installations if required.

A summary of the highlighted application is displayed below the list; the user should enter this summary when the application is created.

The dialog button functions are described as follows:

- |                  |   |
|------------------|---|
| <b>New</b>       | Allows a new application to be defined in the <b>New Application Definition</b> dialog box.<br>Keyboard shortcut: <b>Insert</b> .                 |
| <b>Copy</b>      | Creates a copy of the highlighted application. The new application is allocated a modified name ( <b>Copy of ...</b> ).                           |
| <b>Edit...</b>   | Allows the highlighted application to be edited in the <b>Edit Application Definition</b> dialog box.<br>Shortcut: Double-click application name. |
| <b>Rename...</b> | Allows the highlighted application to be renamed.<br>Keyboard shortcut: <b>F2</b> .   |
| <b>Delete</b>    | Deletes the highlighted application after receiving confirmation from the user.<br>Keyboard shortcut: <b>Delete</b> .                             |

**Auto Create** Creates an application definition for each MHP application that is found in the stream. The boot class for each application is also set up.

Select **OK** to close the dialog box. All of the buttons, except **New**, are disabled unless an application is highlighted; **New** is always enabled.

## Application Definition

Applications are defined using the **New Application Definition** dialog as shown in the following illustration:

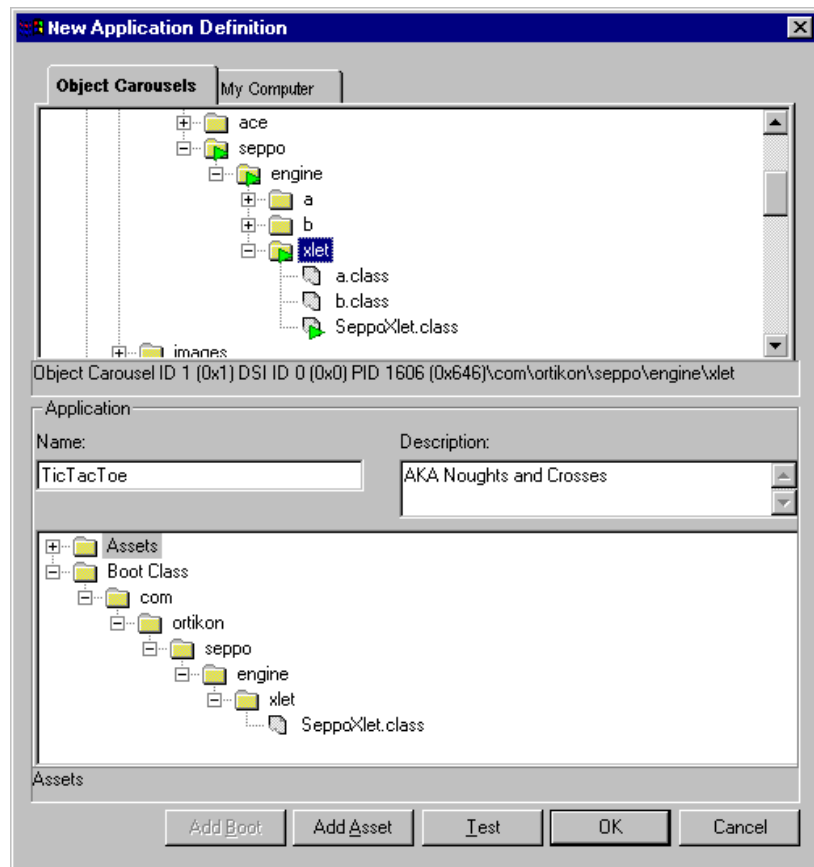

(Initially the Application panes will be empty except for the root nodes (**Boot Class** and **Assets**)).

The elements of the **New Application Definition** dialog box are as follows:

**Object Carousels** tab: This displays all of the object carousels in the current transport stream. Note that if the current transport stream carries no object carousels, then none will be displayed here.

The example screenshot below shows the Object Carousels displayed in the **New Application Definition** dialog box overlaid onto the standard Object Carousel views.

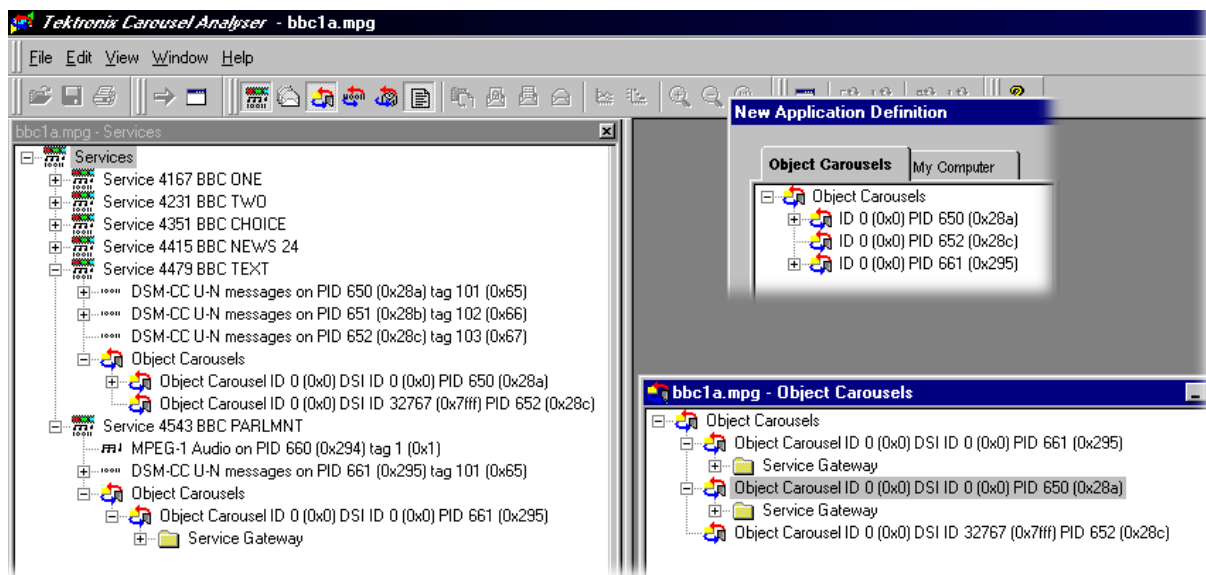

**Name** Enter the name of the application.

**Description** An optional field that allows a brief description of the application to be entered.

The boot class and the assets are displayed as parts of a tree structure in the lower pane. The boot class is the object that must be loaded first in an application (an executable image). Assets are data objects to be used by the Boot Class in the same carousel (for example, picture files, and text files).

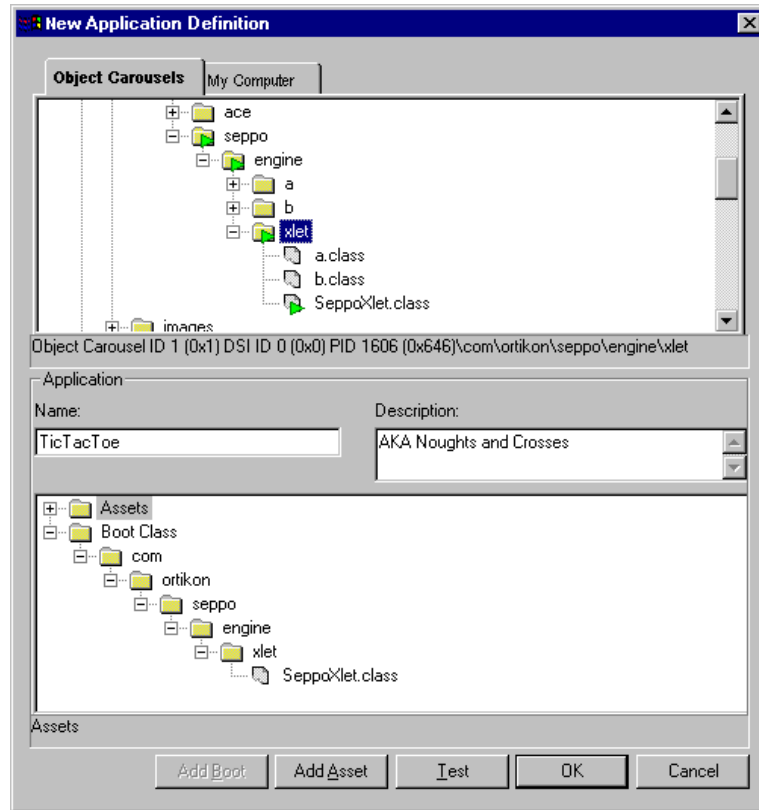

Selecting the **OK** button closes the dialog box and stores the new application data. The action will be refused if a boot class object has not been specified. If a duplicate application name has been entered, it must be renamed.

The boot class must be in the associated carousel; if it is not, the timing test cannot be performed. An asset is a BIOP object in the carousel that is used by the boot class. If the asset is not in the associated carousel, the user will be warned that the assets could not be found and the tests will be performed as if those assets had not been defined.

Selecting the **Cancel** button closes the dialog and discards the new application data.

### Testing an Application

The **Test** button at the bottom of the application dialog box allows items in the application to be tested against the currently selected carousel. This can be used to ensure that the correct carousel has been selected for the application and that all of the objects are present. The results of the test are displayed in the **Application Test** dialog.

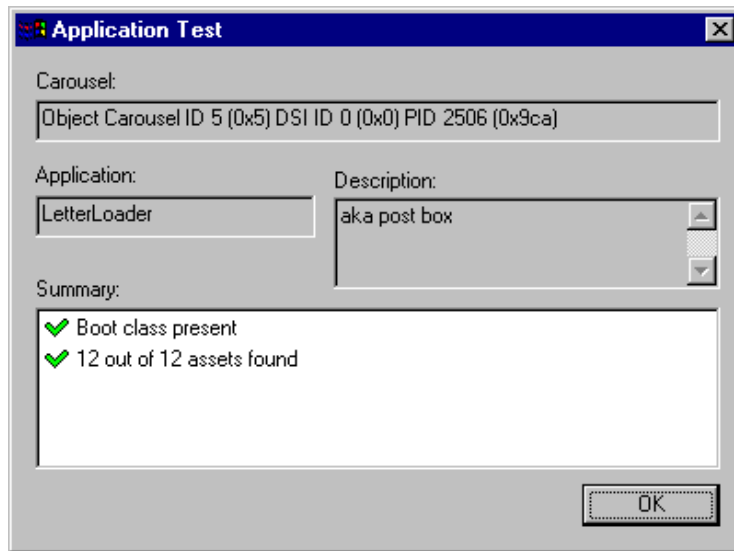

### Adding Objects to the Application

Objects are moved from the Object Carousel pane to the Boot Class or Asset panes using the **Add Asset** button. To do this, highlight the object in the Object Carousel pane, select **Add Asset**, and note that the object is added to the adjacent application structure.

- Making a node that has children an asset will automatically include all the children as assets. To include every object in a carousel, add the carousel root node to the application.
- The boot class can only contain one object; it may be at any depth in the directory structure.
- Adding an object to the Boot Class will displace any existing object.
- Moving assets from the Object Carousel will automatically recreate the directory structure from the object carousel.
- Moving assets from the hard disk directory tree will only recreate the structure below the source tree node. When moving assets from the directory tree, highlight a node in the asset tree as a target.
- A right-click context menu is available at all nodes in the application structure; available options will depend on the node type.

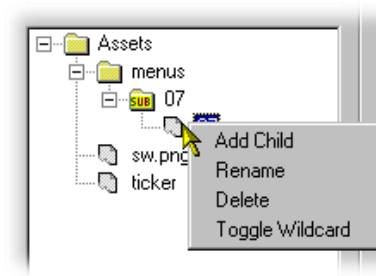

The context menu options operate on the currently highlighted node in the application structure as follows:

- Add Child**                      Adds a child node. It can be subsequently renamed to indicate an object.
- Rename**                              Allows a node to be renamed.
- Delete**                                Deletes the node.
- Toggle Wildcard**                  Asset directory nodes can be identified as wildcard entries. A wildcard directory indicates that the directory and all of its children at the time of analysis are defined as assets.

**Editing an Application**          Application editing is similar to creating a new application.

## Application Timing

The Application Timing feature allows the user to observe the effect in terms of download time of one or more applications being timed with an object carousel.

In practice, an object carousel is identified and one or more applications are selected from the current application list to be timed with it. As each application is selected, the software will check the availability of the Boot Class and Assets. If the Boot Class cannot be found, the timing operation will fail. If Assets cannot be found, the timing tests can still be performed, but they will not represent the true effect of the application on a particular carousel.

Progress bars are displayed while the tests are being performed.

The results of the application timing tests are presented in tabular form.

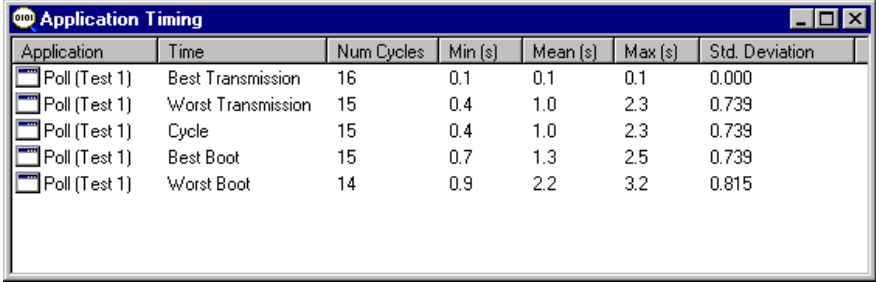

Application	Time	Num Cycles	Min (s)	Mean (s)	Max (s)	Std. Deviation
Poll (Test 1)	Best Transmission	16	0.1	0.1	0.1	0.000
Poll (Test 1)	Worst Transmission	15	0.4	1.0	2.3	0.739
Poll (Test 1)	Cycle	15	0.4	1.0	2.3	0.739
Poll (Test 1)	Best Boot	15	0.7	1.3	2.5	0.739
Poll (Test 1)	Worst Boot	14	0.9	2.2	3.2	0.815



Data displayed in tabular form can be displayed in graphical form or exported to a tab separated file.

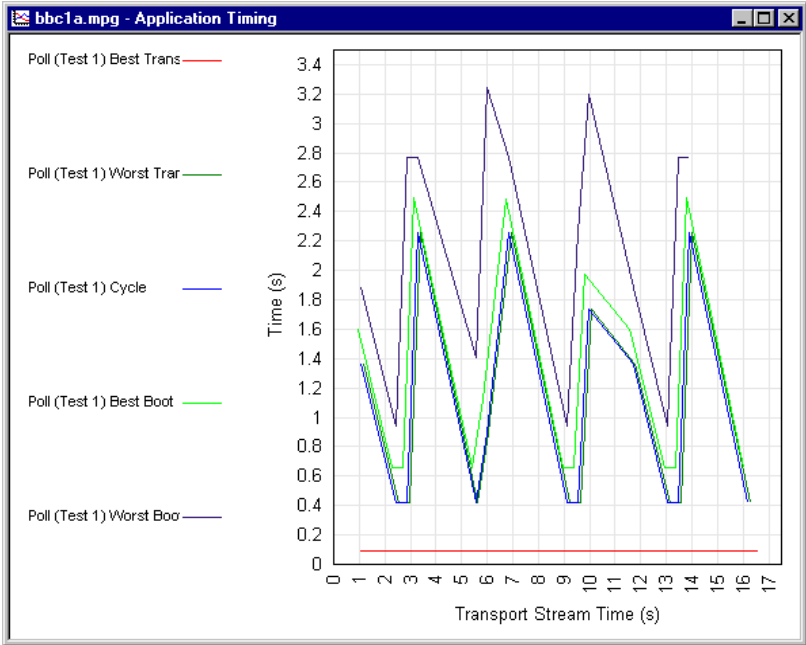

**Explanation of Timing Tests**

This section gives a graphical explanation of each of the application timing tests.

The calculations assume that control information (DSI/DII; that is, SI/PSI information, for example, PAT, PMT) has been cached.

The boot class must be received before any of the assets can be received. This simulates the STB not knowing which carousel objects the boot class depends on until it has completely received and processed it.

**Best Transmission Time.** From the start of a boot class to the end of the last asset.

The true application load time is the transmission time plus the time taken by the set-top box (STB) to load the application. The time taken by the STB to load the application is not included in these tests.

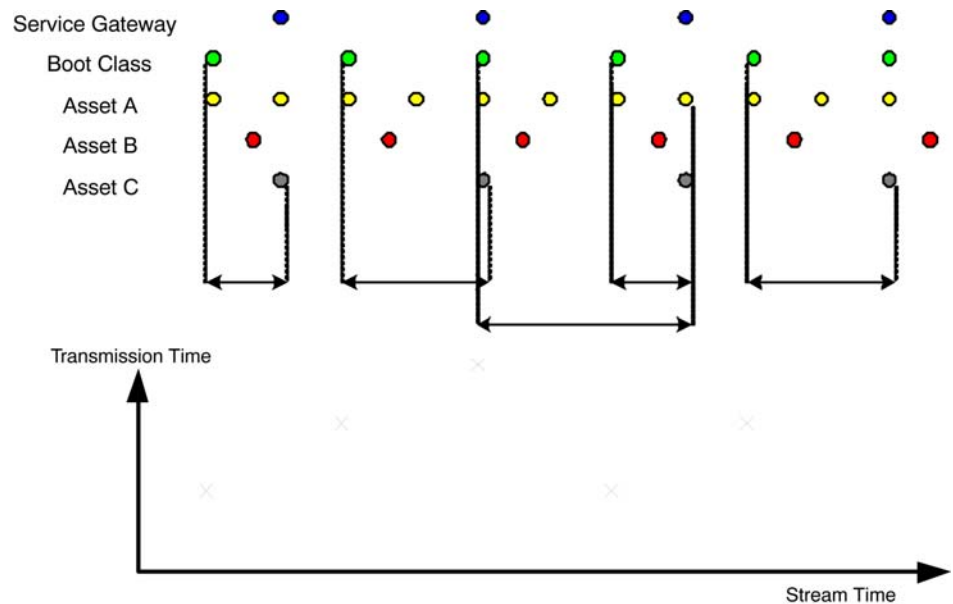

**Worst Transmission Time.** From the end of a boot class, through the next boot class, to the end of the last asset.

The true application load time is the transmission time plus the time taken by the set-top box (STB) to load the application. The time taken by the STB to load the application is not included in these tests.

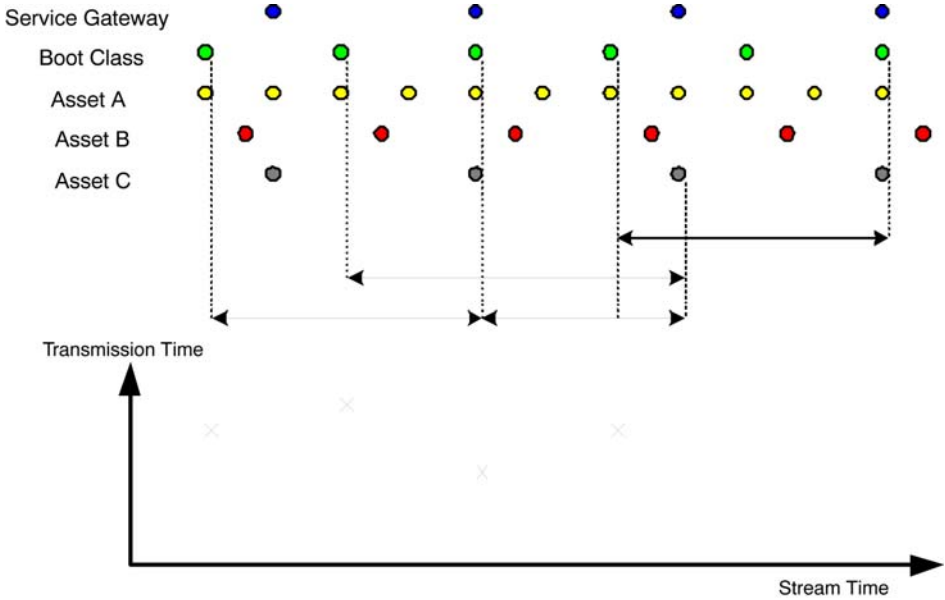

**Cycle Time.** From the start of a boot class, through the last asset, to the start of the next boot class.

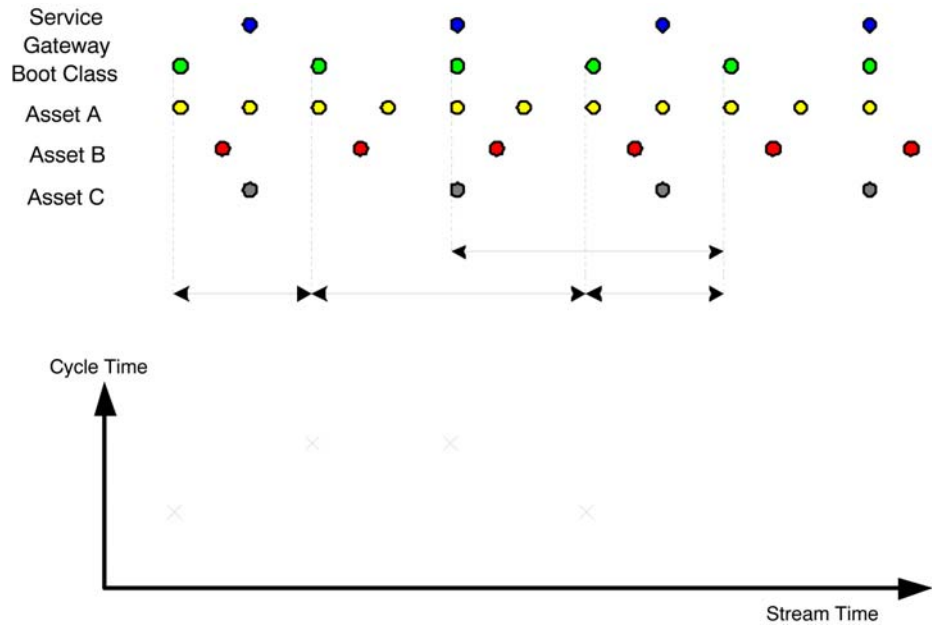

**Best Boot Time.** From the start of a service gateway, through the next boot class, to the end of the last asset.

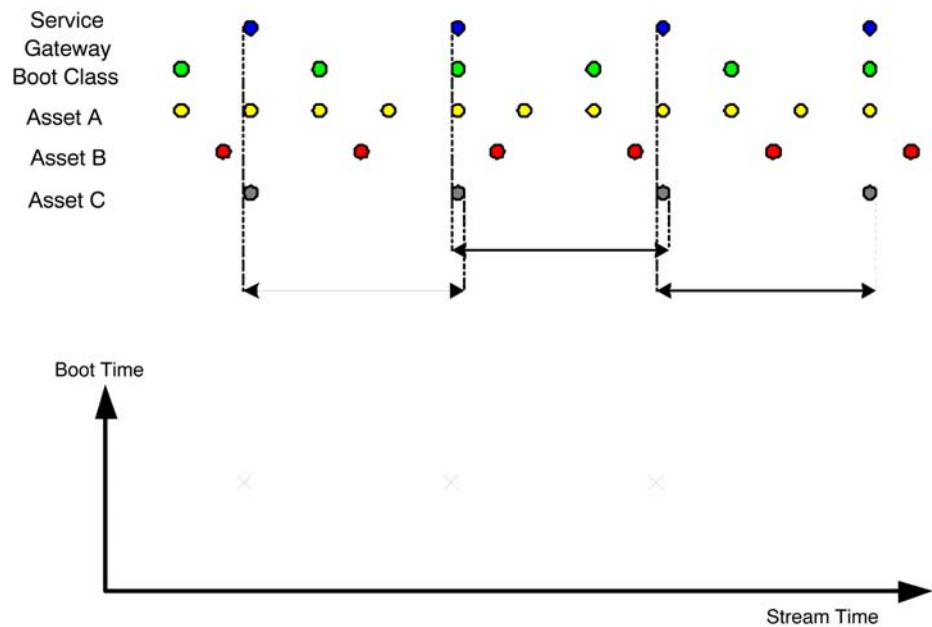

**Worst Boot Time.** From the end of a service gateway, through the next service gateway, through the next boot class, to the end of the last asset.

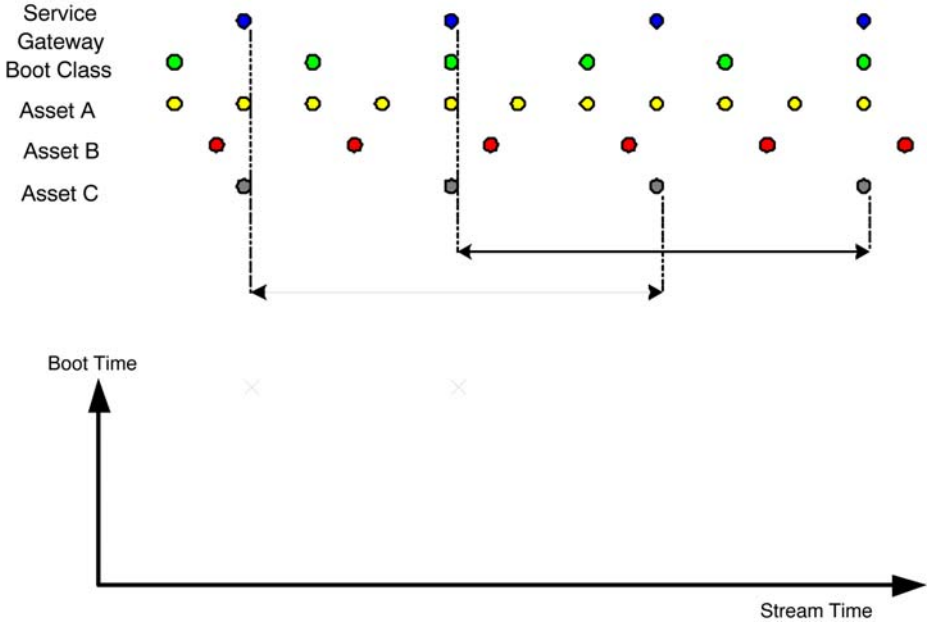

**Cold Boot Time.** Whereas the other timing methods assume that control information (PAT, PMT, DSM-CC section, etc.) has been cached, this method does not.

The user defines a sampling frequency, which is timed to start the download and observe how long it takes to signal the carousel and download the service gateway, the boot class and all of the assets. For example, in a 60-second stream, a **Start Point** (on the **Cold Boot Time Settings** dialog) of five seconds will sample the download time twelve times. The result is added to the Application Timing results table and graph.

The boot class must be received before any of the assets can be received. This simulates the STB, not knowing which carousel objects the boot class depends on until it has completely received and processed it.

Directories must be received before any child objects can be received in this case. This is because this timing method assumes no signaling caching.

The end of each cycle will be the end of the module containing the last asset. This is an important distinction because an asset may not be the only one in that module.

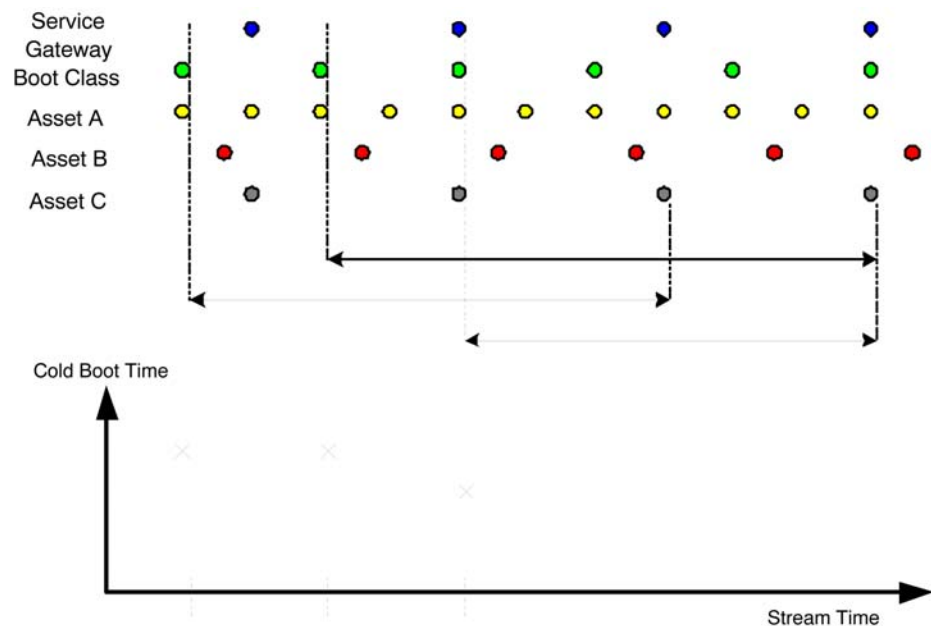

### Setting up a Timing Test

It is assumed that applications have been created as described in the previous section.

1. With the Object Carousel view active, select **View > Timing > Application Timing**.

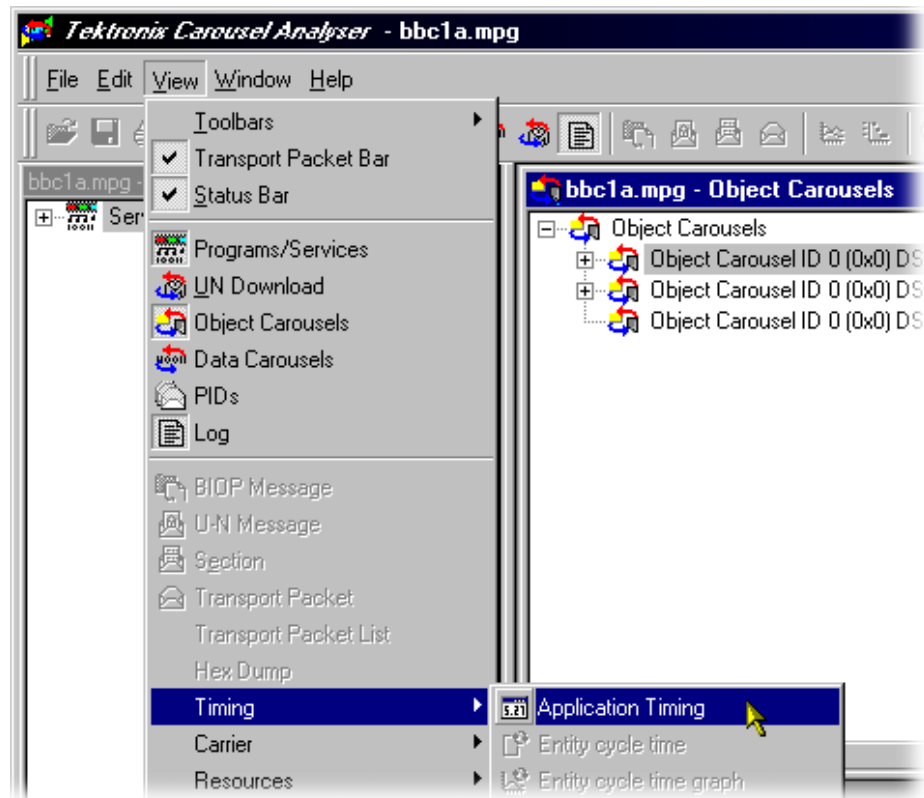

Alternatively, highlight an object carousel and select **View Application Timing** from the right-click menu (not shown).

2. The **Timing Application** dialog is displayed:

The dialog displays the selected object carousel identity and the applications that are already defined.

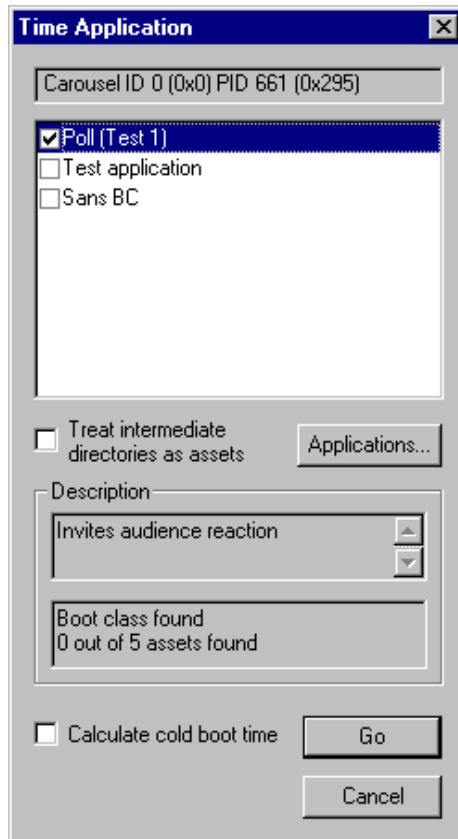

Applications to be associated with the object carousel are selected by enabling the adjacent checkbox.

Highlighting an application name will display its description and a brief report on the availability of the boot class and assets. If the boot class is reported as being not present, the timing operation will be aborted after the first test pass.

Select **Applications...** to open the **Applications** management dialog (see page 6–71).

On first opening this dialog, a simple test is performed to detect the presence of the required boot classes. Applications for which the boot class is found will be enabled.

Subsequently, user selections will be recalled.



**Treat Intermediate Directories as Assets:**

If this checkbox is enabled, all directories that form part of the asset path are also treated as assets. They must be downloaded as part of the timing test. This will not usually have any significant impact on the results because directories are generally much smaller and transmitted at a higher frequency than files.

**Calculate Cold Boot Time:**

If this checkbox is enabled, the Cold Boot timing test will be applied (see page 6–84); this may take some time.

**NOTE.** *In MHP mode, if the Cold Boot time is to include the AIT acquisition time, the Application Timing selection must be made from an MHP application node (Java or HTML). By selecting an MHP application, the application’s AIT will be automatically included in the Cold Boot timing.*

**3. Select Go to start the timing tests.**

If the Calculate cold boot time checkbox was enabled, the Cold Boot Time Settings dialog is displayed. Enter the starting point repetition rate required.

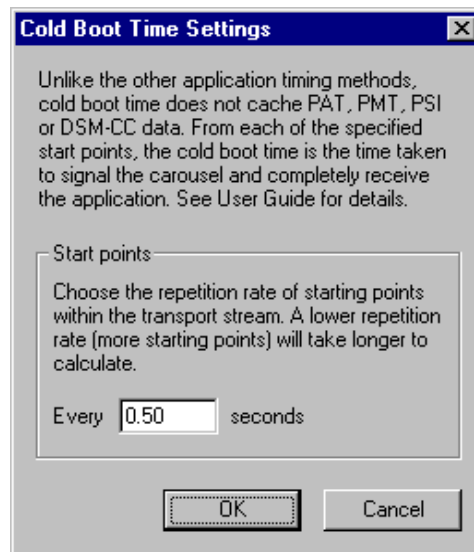

Select **OK** to continue with the tests.

Progress bars will be displayed while the test is being carried out.

- On completion of the test, the **Application Timing** results table is displayed.

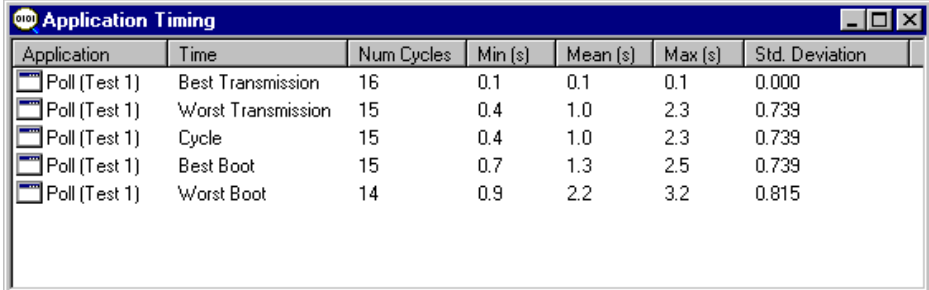

Application	Time	Num Cycles	Min (s)	Mean (s)	Max (s)	Std. Deviation
Poll (Test 1)	Best Transmission	16	0.1	0.1	0.1	0.000
Poll (Test 1)	Worst Transmission	15	0.4	1.0	2.3	0.739
Poll (Test 1)	Cycle	15	0.4	1.0	2.3	0.739
Poll (Test 1)	Best Boot	15	0.7	1.3	2.5	0.739
Poll (Test 1)	Worst Boot	14	0.9	2.2	3.2	0.815

The column headings are largely self-explanatory. **Number of Cycles** shows the number of times that the test could be calculated for the stream.

- To display the results in graphical form, highlight a test name and select **Graph...** from the right-click menu.

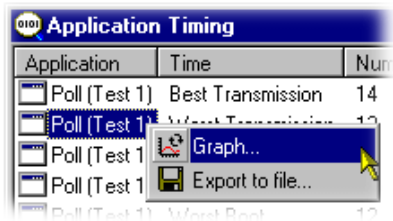

If another test is selected, the results are overlaid. Color coding is used to identify each result.

The screenshot below illustrates a graph showing all five test results (Cold Boot not shown).

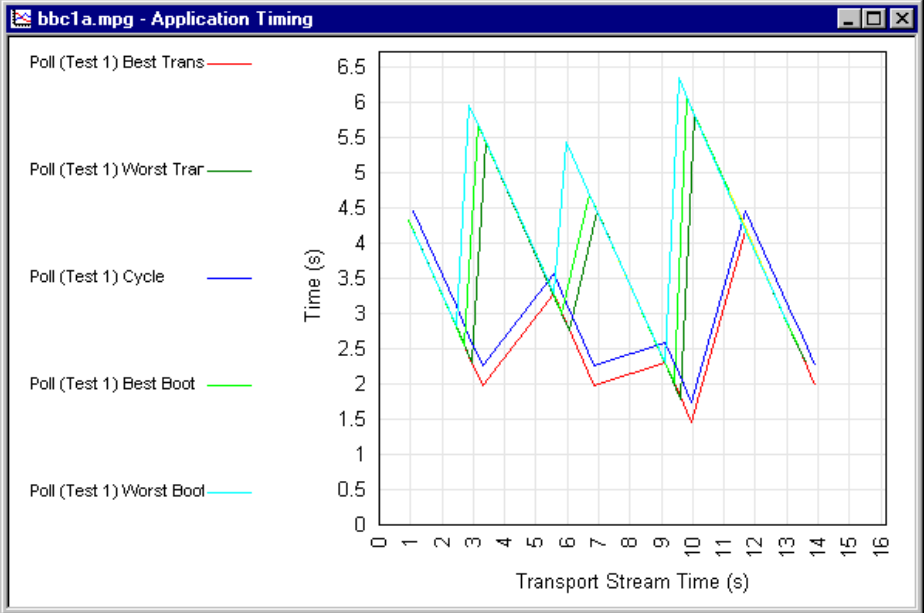

Zoom in and zoom out buttons are provided on the toolbar (or use the tab and shift-tab keys on the keyboard).

Alternatively a precise area can be selected by dragging the mouse over the required range (hold the left-button, move the mouse, release the button).

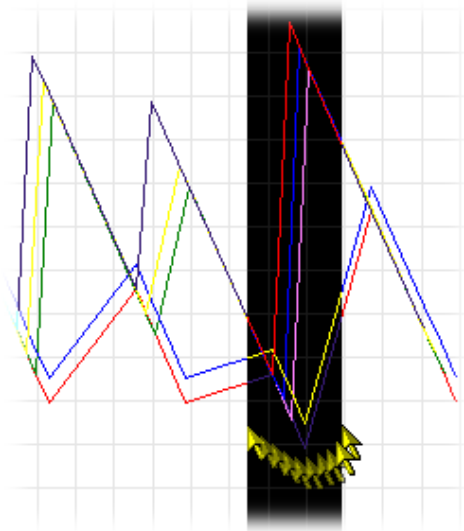

When the mouse button is released, the zoomed area of the graph will be displayed immediately (as shown below).

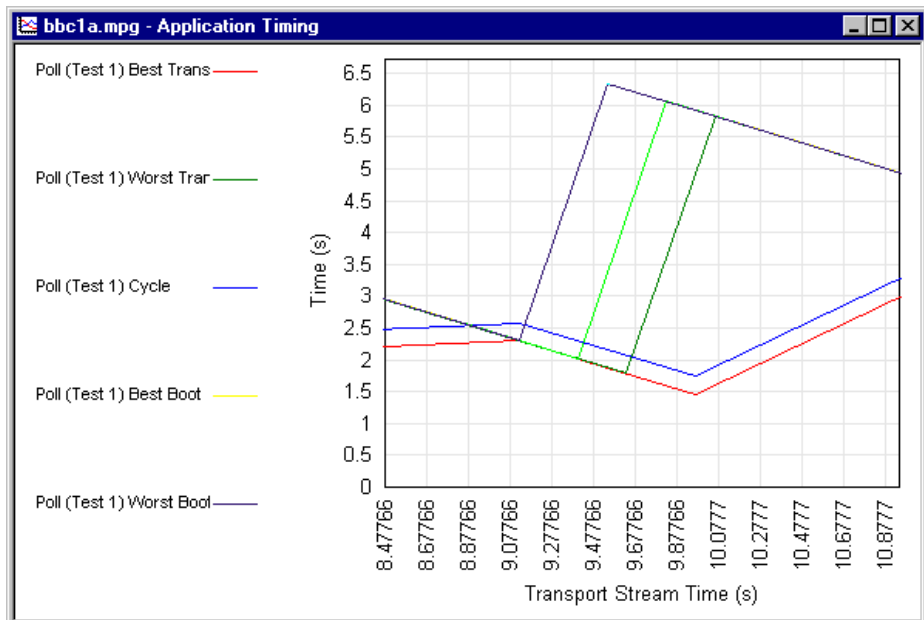

# MHP Support

Although described separately here, MHP Object Carousel support is fully integrated into Carousel Analyzer. MHP applications are displayed in the Services and Object Carousel views. The features described here can be accessed from menu options and right-click context menus.

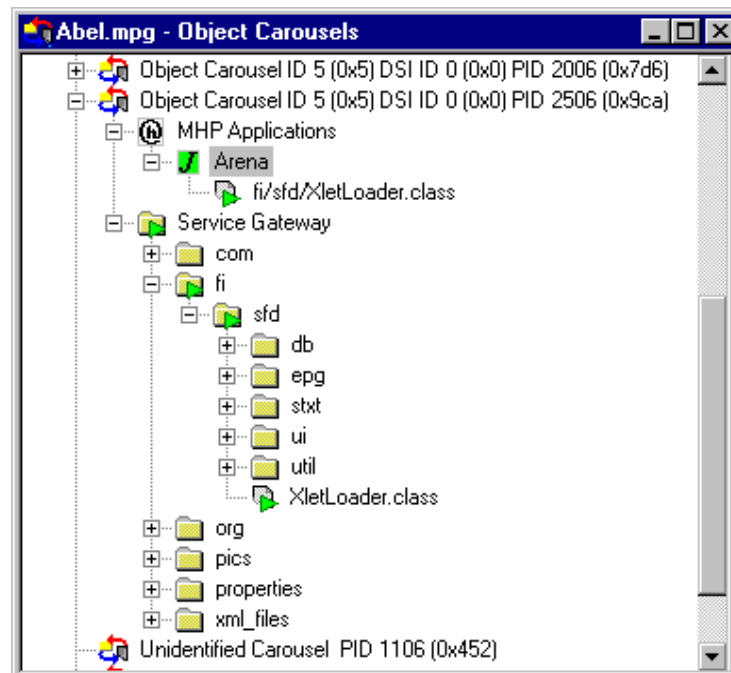

The MHP application (🟩) is identified by its name in the AIT. If the boot class is found in the Service Gateway, it is attached as a child of the MHP application. As a visual aid, boot class items are identified in the Service Gateway by green triangles overlaying the primary icon. The path in which the boot class resides is also indicated by green triangles.

Applications are designated as Java (🟩) or HTML (🟨). The color of the icon represents the running status of the application when the carousel was recorded; green indicates running, yellow indicates ready and red indicates not running.

**Right-Click Menu Options** Right-clicking on an MHP application node will display the following menus:

**View Application Timing**

(See *Application Timing*, page 6–71)

**View AIT**

Opens the AIT structure view (see also *Structure Views*, page 6–52)

**View Application Lifetime**

(See *Application Lifetimes*, page 6–71)

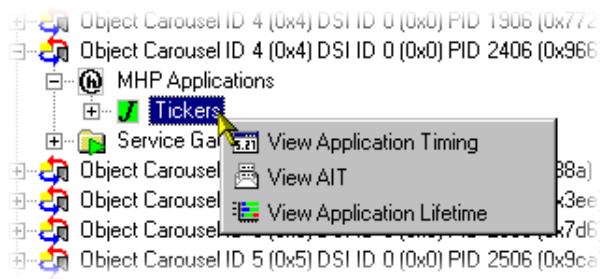

## Application Lifetimes

This Gantt style graph displays an analysis of the lifetime of an MHP application. Multiple applications can be displayed; each application is subdivided and color-coded to indicate the changing state of the application.

The Applications Lifetimes view can be opened by highlighting an MHP application node and selecting either the toolbar icon or **View Application Lifetime** from the right-click menu.

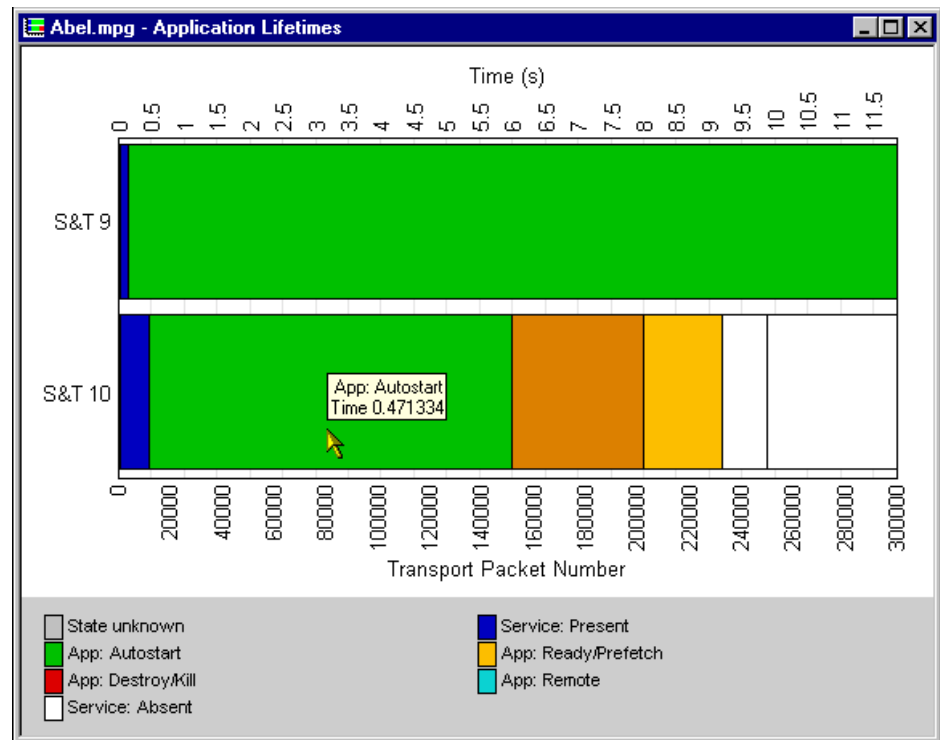

A key to the color codes is displayed at the bottom of the view. Each application is labeled. Placing the cursor over a color block displays details of the block, including the block start time.





# Reference

## Script Files

The following scripts (Table 6–11) are shared between the Carousel Analyzer and other Tektronix products. They exist in the Tektronix\Scripts directory.

**Table 6–11: Script Files - General**

<b>Script file name</b>	<b>Purpose</b>
MPEG.scp	Scripts for MPEG sections and descriptors.
DVB.scp	Scripts for DVB sections and descriptors.
ISDB-T.scp	Script for ISDB-T sections and descriptors.
ISDB-S.scp	Script for ISDB-S sections and descriptors.
MHP.scp	Script for AIT table.
MPE.scp	Scripts for DVB datagrams.
DSMCCv2.scp	General purpose DSMCC structures.
DSMCC.scp	Scripts for (DVB) DSM-CC sections.
ISDB_DSMCC.scp	ISDB version of the DSM-CC script.

The following scripts (Table 6–12) are used only by the Carousel Analyzer. They exist in the Tektronix\DataTestSystem\Scripts directory.

**Table 6–12: Script Files - Carousel Analyzer**

Script file name	Purpose
Transport.scp	Script for transport packets.
Pat_Cat.scp	Script for PAT and CAT sections.
Biop.scp	Scripts for BIOP messages.
DSMCC_DataCarouselObject.scp	Script for DSM-CC objects, which relate a Data Carousel.
DSMCC_DataCarouselSection.scp	Script for DSM-CC sections, which relate a Data Carousel.
DSMCC_ObjectCarouselObject.scp	Script for DSM-CC objects, which relate an Object Carousel.
DSMCC_ObjectCarouselSection.scp	Script for DSM-CC sections, which relate an Object Carousel.
DSMCC_Object	Script for DSM-CC objects, whose content is not assumed to be either data or objects.

## Error Checking

DSM-CC sections have two bit fields called `section_syntax_indicator` and `private_indicator` (Ref 13818-6 section 9.2.2). If the `section_syntax_indicator` field is 1, there is a CRC32 at the end of the section; if set to 0, there is a checksum at the end of the section. The `private_data` field should always be the complement of the `section_syntax_indicator` field.

If both these fields are set to the same value, the application cannot be absolutely sure whether a CRC or a checksum is being used. It therefore attempts to use the CRC method first and then the checksum. If neither method works, the section is rejected.

Currently nothing will be reported in the error logs if these bits are set incorrectly. This issue will be addressed in a future release of Carousel Analyzer.

## References

- [1] ISO/IEC 13818-1 Information technology - Generic coding of moving pictures and associated audio information: Systems [MPEG]
- [2] ISO/IEC 13818-6 Information technology - Generic coding of moving pictures and associated audio information - Part 6: Extension for Digital Storage Media Command and Control [MPEG]
- [3] ETS 300 468 Digital broadcasting systems for television, sound and data services; Specification of Service Information in Digital Video Broadcasting [DVB]
- [4] EN 301 192 Specification for data broadcasting [DVB]
- [5] A027 Specification for the transmission of data services in DVB bitstreams [DVB]
- [6] A047 Implementation guidelines for Data Broadcasting [DVB]
- [7] SI-DAT 382 Rev.4 Implementation guidelines for data broadcasting [DVB]
- [8] Digital terrestrial television MHEG5 specification [DTG]
- [9] ISO/IEC 13522-5:1996(E) MHEG-5 IS [MHEG]
- [10] A tutorial introduction to MHEG-5 [Authors: Strategy and Technology Ltd]
- [11] ARIB STD - B24 Data Coding and Transmission Specification for Digital Broadcasting
- [12] Multimedia Home Platform, ETSI TS 101 812 v1.1.1 [DVB]





# **Carousel Generator**



# Table of Contents

<b>Carousel Generator - Getting Started</b> .....	<b>7-1</b>
Data Broadcasting Overview .....	7-1
Carousel Generator Overview .....	7-2
Starting the Application .....	7-6
<b>Carousel Wizard</b> .....	<b>7-9</b>
Step 1: Select Carousel .....	7-11
Step 2: Carousel Properties .....	7-12
Step 3: Carousel Contents .....	7-13
Step 4: Collection Contents .....	7-15
Step 5: Imported Elementary Streams .....	7-18
Step 6: Program Entry .....	7-20
Step 7: Output Stream Properties .....	7-21
Step 8: Congratulations .....	7-22
<b>Menus and Controls</b> .....	<b>7-23</b>
Menu Options .....	7-23
Toolbars .....	7-27
Log Window .....	7-30
Status Bar .....	7-31
Properties Window (List Control) .....	7-31
<b>Carousel Generation</b> .....	<b>7-33</b>
Setting Overall Carousel Generator Properties .....	7-33
Creating a Session .....	7-39
Selecting the Carousel Type .....	7-41
Modifying the Carousel Properties .....	7-42
Carousel Contents .....	7-51
Collections .....	7-66
Programs .....	7-70
Output Stream Generation .....	7-79
Carousel Definition File .....	7-79
<b>PSI and SI in the Carousel Generator Output Stream</b> .....	<b>7-81</b>
PSI/SI Mode Settings .....	7-81
MPEG PSI tables .....	7-82
DVB SI Tables .....	7-89
Summary .....	7-103

## List of Figures

<b>Figure 7-1: MPEG PSI .....</b>	<b>7-74</b>
<b>Figure 7-2: DVB SI .....</b>	<b>7-74</b>



## List of Tables

<b>Table 7-1: File menu options</b> .....	7-23
<b>Table 7-2: Edit menu options</b> .....	7-24
<b>Table 7-3: View menu options</b> .....	7-24
<b>Table 7-4: Session menu options</b> .....	7-25
<b>Table 7-5: Player menu options</b> .....	7-26
<b>Table 7-6: Tools menu options</b> .....	7-26
<b>Table 7-7: Help menu options</b> .....	7-26
<b>Table 7-8: Generator toolbar icons</b> .....	7-27
<b>Table 7-9: Player toolbar icons</b> .....	7-28
<b>Table 7-10: Session icons</b> .....	7-29
<b>Table 7-11: Program Association Table (PAT)</b> .....	7-82
<b>Table 7-12: Program Map Table (PMT)</b> .....	7-83
<b>Table 7-13: DSM-CC object carousels - Carousel identifier descriptor</b>	7-84
<b>Table 7-14: DSM-CC object carousels - Association tag descriptor</b>	7-85
<b>Table 7-15: DVB object carousels - Private_data_byte syntax</b> ....	7-86
<b>Table 7-16: DVB object carousels - Descriptors</b> .....	7-86
<b>Table 7-17: DTT object carousels</b> .....	7-87
<b>Table 7-18: MHP object carousels - Application signaling</b> .....	7-88
<b>Table 7-19: MHP object carousels - ID selector</b> .....	7-88
<b>Table 7-20: Network information table</b> .....	7-89
<b>Table 7-21: Service Description Table (SDT)</b> .....	7-91
<b>Table 7-22: Service descriptor</b> .....	7-92
<b>Table 7-23: Data broadcast descriptor</b> .....	7-92
<b>Table 7-24: DVB object carousel</b> .....	7-93
<b>Table 7-25: DTT object carousel</b> .....	7-94
<b>Table 7-26: Event Information Table (EIT)</b> .....	7-95
<b>Table 7-27: Short event descriptor</b> .....	7-96
<b>Table 7-28: Time and date table</b> .....	7-97
<b>Table 7-29: Application information table</b> .....	7-98
<b>Table 7-30: Application descriptor</b> .....	7-99
<b>Table 7-31: Application name descriptor</b> .....	7-100
<b>Table 7-32: Transport protocol descriptor</b> .....	7-101
<b>Table 7-33: Java application descriptor</b> .....	7-101
<b>Table 7-34: Java application location descriptor</b> .....	7-102
<b>Table 7-35: HTML application descriptor</b> .....	7-102
<b>Table 7-36: HTML application location descriptor</b> .....	7-103



# Carousel Generator - Getting Started

The Carousel Generator is aimed principally at the content provider user who simply wants to create a carousel to deliver content to a set-top box quickly and efficiently. The product also aims to support the more experienced MPEG user who wants to modify a carousel to test the effects on equipment along the broadcast chain. Similarly, the more experienced MPEG user can incorporate a carousel into a transport stream alongside video and audio content.

The assembled transport stream can be saved to an MPEG file.

## Data Broadcasting Overview

Data Broadcasting allows data to be transmitted in a similar way to the way in which video and audio services are delivered to end users. Object and Data Carousels are intended for the periodic transmission of information in a transport stream. Data Carousels contain modules of data of unspecified content, whereas Object Carousels contain identifiable data objects, such as JPEG files, text files and, application software. Multimedia Home Platform (MHP) builds on object carousels by defining parameters such as the boot class and application life cycle in the Application Information Table (AIT).

The diagram below shows how information carried by data and object carousels is subdivided and ultimately carried by the transport stream.

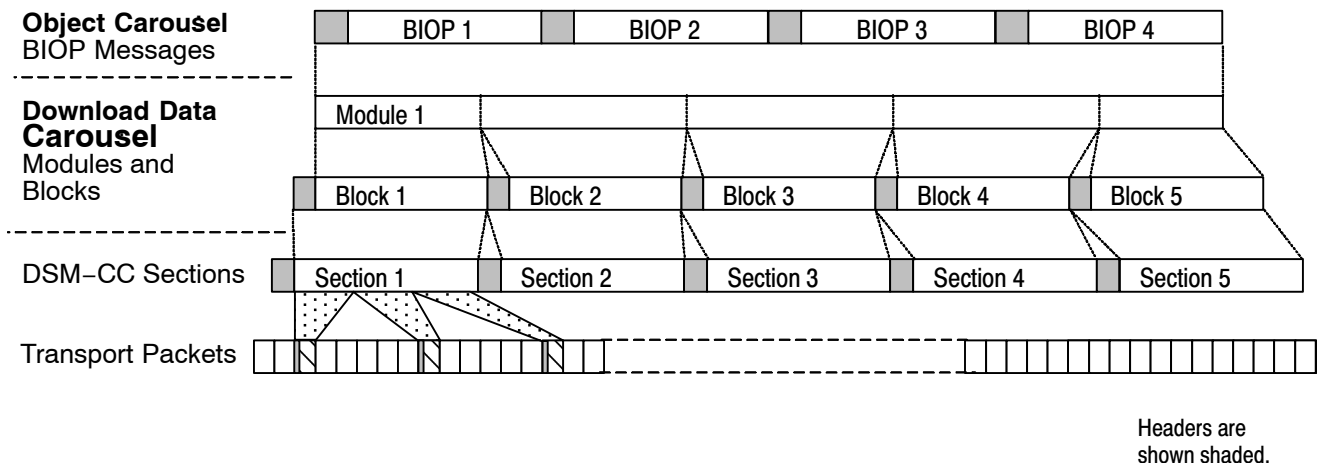

BIOP messages contain a message header, a message sub-header and the message body, which contains data. The message body may contain complete data objects.

BIOP messages are broadcast in modules. A module is formed from one or more concatenated, complete BIOP messages.

Each Module is fragmented into one or more Download Data Blocks that are in turn transmitted in corresponding DSM-CC Sections.

Sections are transmitted in packets in the Transport Stream.

## **Carousel Generator Overview**

Activity in the Carousel Generator is referred to as a “session”. During a session, data objects are assembled into one or more carousels. Video and audio content can also be added. Mandatory SI tables are added automatically. The structure of the carousel can be saved in XML format; this definition file can be subsequently reopened in a new session for further edits.

The end result of a session is the creation of a transport stream, which can be saved to a file.

One of the main advantages of Carousel Generator is that many of the more complex concepts in the various Object Carousel standards are hidden from the user for the sake of clarity and user friendliness.

Three views of the assembled stream are offered: Carousels, Collections and Programs. Each view displays aspects of the stream from a single perspective. The three following screenshots show the same stream in each of the views.

### Carousels View

The Carousels view lists the carousels and the associated objects that are included in the session.

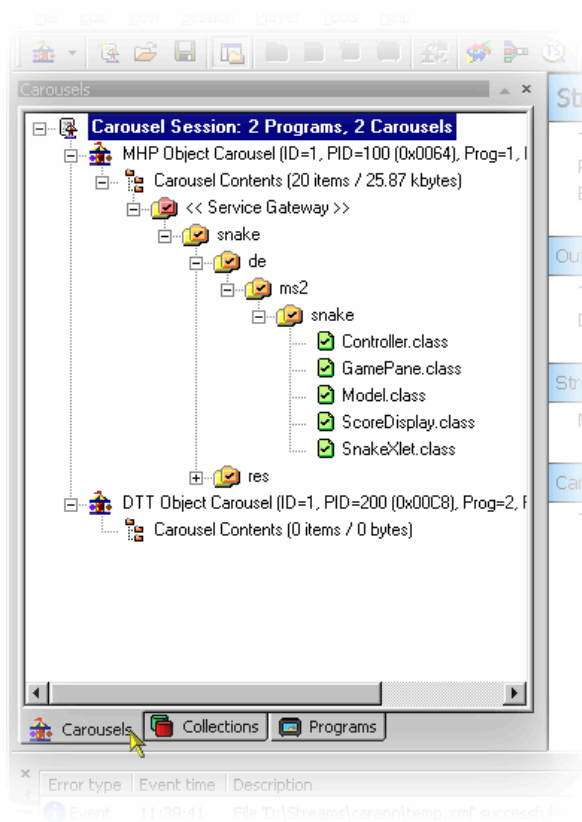

**Carousel Types.** The supported carousel types are as follows:

**Object Carousels:** DSMCC, DVB, DTT, MHP

Object carousels	Reference specification
DSM-CC	Digital Storage Media - Command and Control (MPEG only)
DVB	Digital Video Broadcast
DTT	Digital Terrestrial Television
MHP	Multimedia Home Platform

The type of carousel being edited dictates the available options and user interface elements.

### Collections View

Objects associated with a carousel can be grouped together in collections. The properties of each collection can be adjusted to give the most efficient delivery in the transport stream.

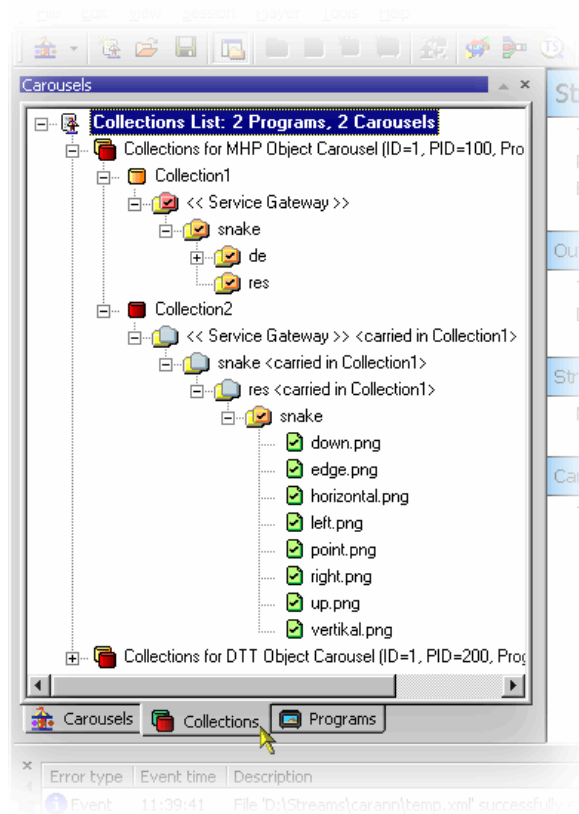

The way that individual objects in a carousel are to be transmitted often varies. Each object in the carousel has properties including its minimum repetition rate (maximum cycle time) and whether it is compressed. Files that need to be transmitted with similar properties or which are logically related can be grouped into a module. As the DSMCC module is a limited size, the process of adding an object to a module would require calculating whether the object would fit into the module’s available space (possibly after compression) and if no space is available, generating a new module and feeding this back to the user. This would slow this aspect of the user interface down appreciably.

Consequently, the concept of a collection is used to replace the size-limited DSMCC module, with a “module of unlimited size”. Any number of objects can be added to a collection; during stream generation, this may translate to many modules with the same properties.

### Programs View

In the Program view, the root is the Carousel Session (as in the other views). Immediately below this are nodes giving access to the supported (mandatory) SI/PSI tables and a listing of PCR PIDs. There is also an Elementary Streams node, which lists all of the imported elementary streams included in the stream and the Program nodes, which show the allocation of carousels and elementary streams to programs.

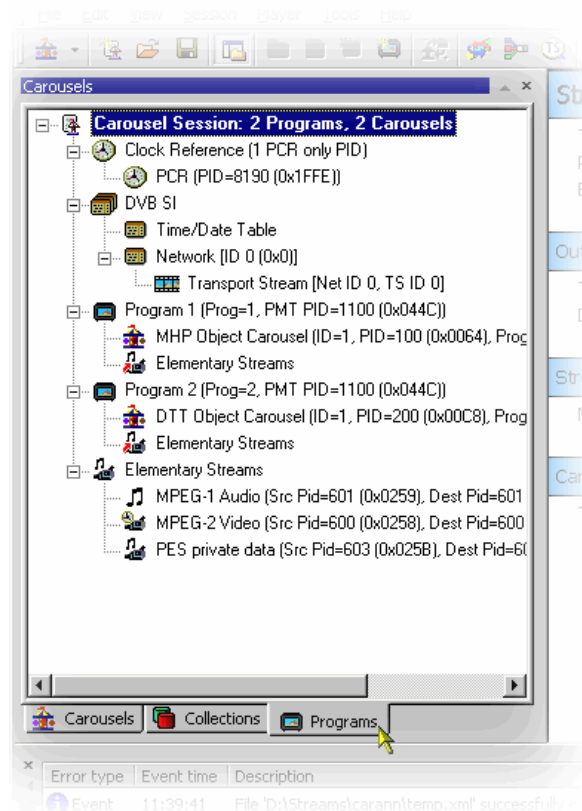

### Carousel Definition File

The current state of the Carousel Generator session can be saved to disk at any time during the creation process, using the carousel definition file. The format of the saved file is standard XML and can be viewed in any XML compatible viewer (for example, Internet Explorer 5 and up); editing the XML file directly is not recommended.

## Starting the Application

The application can be started by selecting the **Tektronix Carousel Generator** option from the **Start > Programs** menu or by double-clicking the **Tektronix Carousel Generator** shortcut on the desktop.

In addition, files with an XML extension have an additional option in the right-click menu (**Open with Carousel Generator**). When this option is selected, Carousel Generator opens and attempts to use the file as a *Carousel Definition file* (see page 7-5).

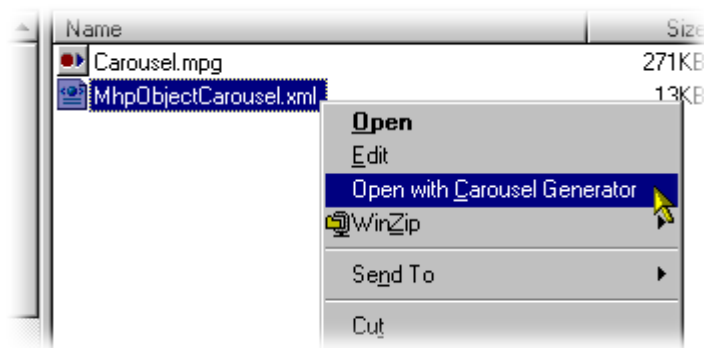



## Initial Appearance

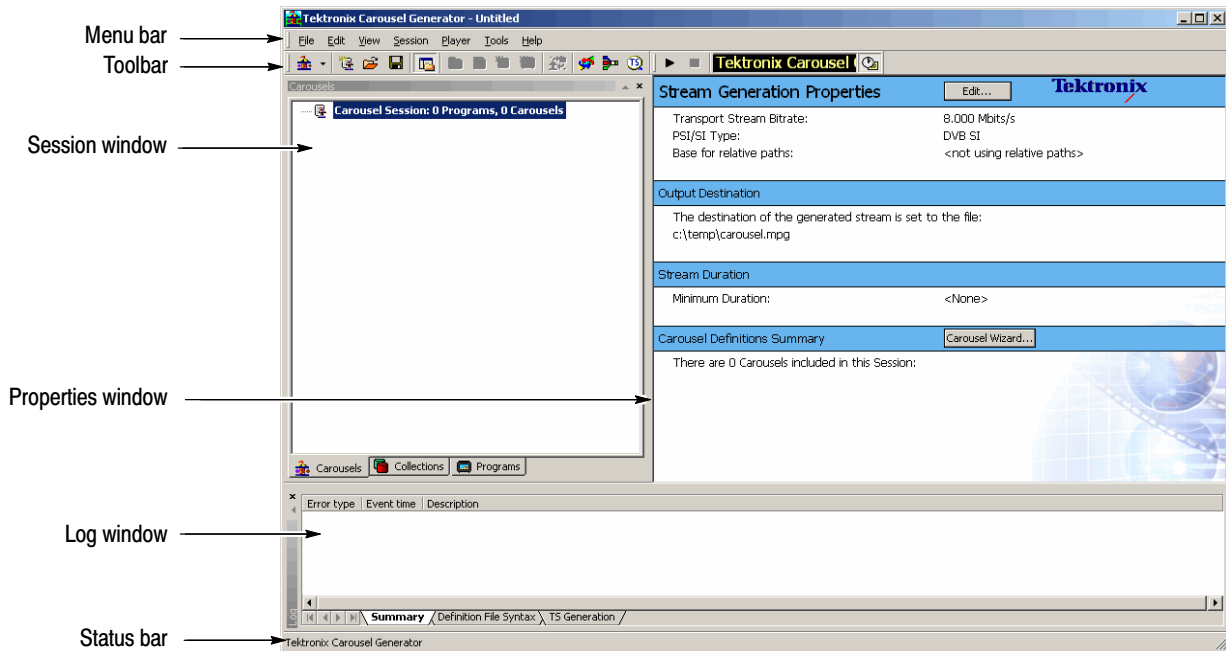

The full range of options available to the Carousel Generator can be accessed by using the Menu Bar. However, the selection of options varies during the stages of carousel creation; unavailable options are normally grayed out. The Toolbar provides shortcuts to the more common options.

The working area of the Carousel Generator screen contains three windows: the Session window, the Properties window and the Log window. The Session window and the Log window can each be either floated (moved to anywhere on the desktop) or docked to one of the four sides of the application window. The content of the Properties window is context-sensitive; it will provide a summary of the properties of the node highlighted in the Session window.

A full description of the Carousel Generator screen components can be found in the *Menus and Controls*, page 7–40.

**Session Window.** The Session window is the workspace in which carousels and collections are built and manipulated. The window has three tabs: Carousels, Collections and Programs. Each window displays different aspects of the current session in the form of a tree structure.

**Carousel Tab**                      The Carousels Session window displays all of the carousels in the current session and the directories and files associated with each carousel. It is in this window that carousels are built and manipulated.

**Collections Tab**                      The Collections Session window displays the collections associated with each carousel and the allocation of files and directories within them.

**Programs Tab**                      The Program session window displays the contents of the stream from the program or service point of view.

**Properties Window.** The Properties window provides an immediate view of the parameters and values associated with each node in the Carousels and Collections Session windows. The values displayed are those of the currently selected node.

**Log Window.** The Log window displays errors and warnings as the carousel building and stream generation progresses.

A full description of the Carousel Generator screen components can be found in the *Menus and Controls*, page 7–23.

# Carousel Wizard

The Carousel Wizard makes the process of creating a single carousel easier. The carousel is added to the current session. The final step of the wizard allows a transport stream to be created using the information in the current session.

Default parameters are provided at all stages of the wizard, but the user can change them either in the wizard screens or subsequently in the various property dialog boxes.

The description in this section provides an overview of the wizard and carousel creation. Individual properties and activities are described in more detail in the *Reference* section. Extensive tooltips are provided with the wizard screens. Place the cursor over any element of a screen to reveal the tooltip.

If a carousel session is in progress, the user must decide whether a new session is required or a new carousel is to be added to an existing session.

To start a new carousel session, select **File > New Carousel Session**.

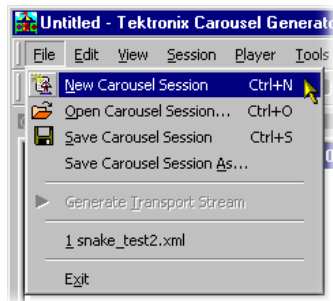

Any open carousel session will be closed with an option to save.

The following screen is displayed:

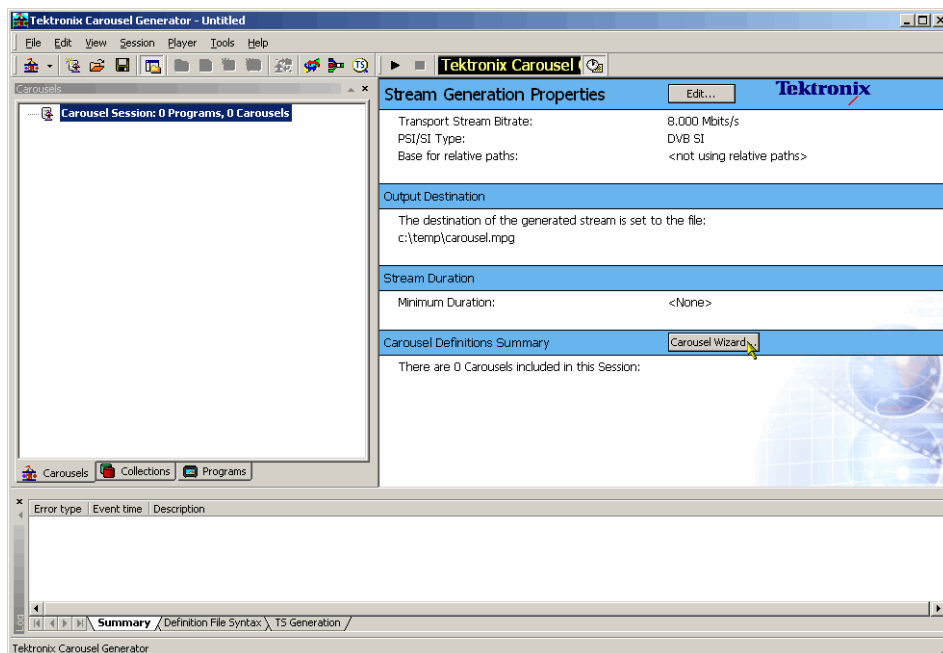

For a new session or adding a carousel to an existing session, the wizard can now be invoked.

## Step 1: Select Carousel

1. In the work area select Carousel Wizard... or select **Session > Carousel Wizard**.

*Step 1: Select Carousel* of the Carousel Wizard is displayed.

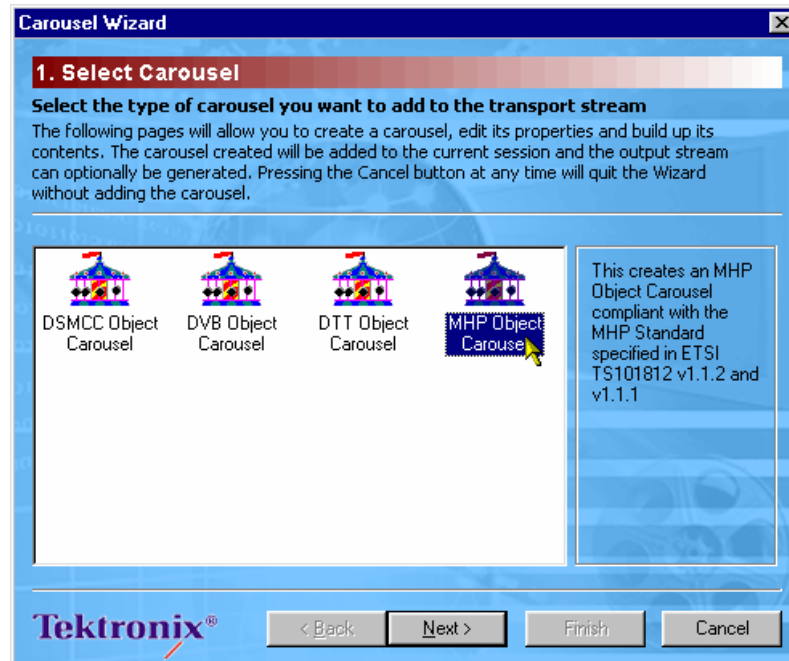

2. Highlight the required Carousel type.

Note that depending on the type selected, some of the subsequent wizard screens will vary in content. The content is dictated by the carousel type selected.

3. Select Next to display *Step 2: Carousel Properties*.

## Step 2: Carousel Properties

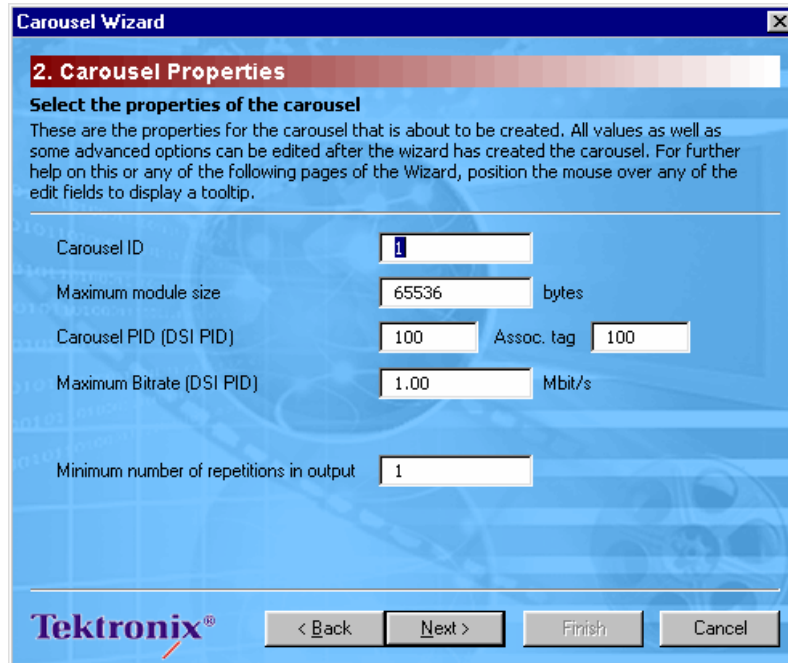

In Step 2, the Carousel Properties are selected. Defaults are supplied but all properties can be edited. Properties can also be edited after the carousel has been created from the main window.

4. Make any required adjustments to the Carousel properties.
5. Select how many times the carousel should appear in the output stream.

**NOTE.** When using the wizard, only a single carousel is being assembled. However, more than one carousel may be created within a session.

*The number of repetitions can be specified for each carousel. The length of the transport stream will be dictated by the carousel that requires the longest time by virtue of its size or the number of requested repetitions. Carousels in the same session requiring less time to fulfill their size/repetition criteria will be repeated.*

6. Select Next to display Step 3: Carousel Contents.

## Step 3: Carousel Contents

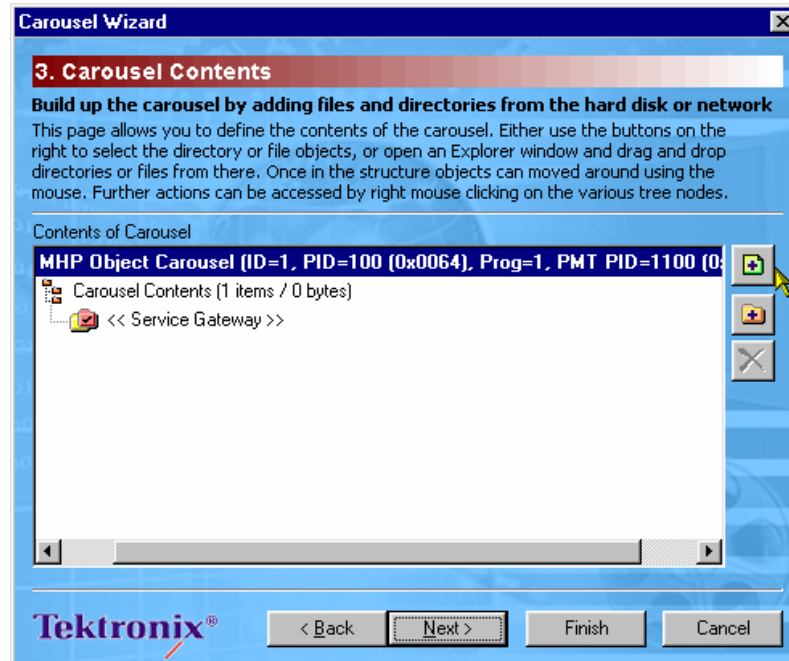

Files and directories containing applications and resources are added to the carousel during this step.

The buttons on the right side of the window allow individual files or complete directory structures to be added to highlighted nodes of the carousel. Files and directories can also be dragged and dropped from Windows Explorer.

Add files:  Add directories: 

Files and directories can be dragged and dropped within the wizard window, to allow final adjustments to be made.

Highlighted files and directories can be also be deleted .

7. Build the carousel structure as required.

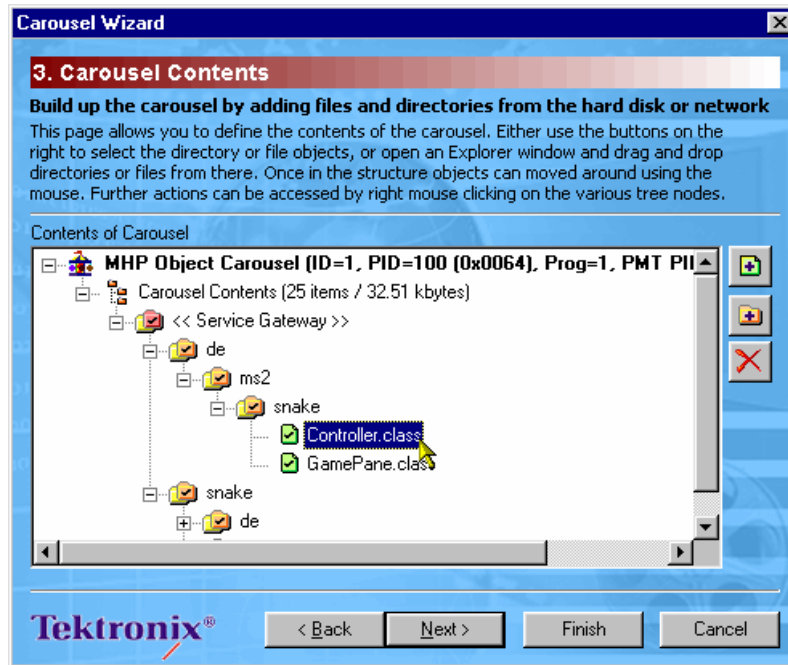

Highlighting an object and selecting Properties from the right-click menu allows access to the object properties.

8. Select Next to display *Step 4: Collection Contents*.



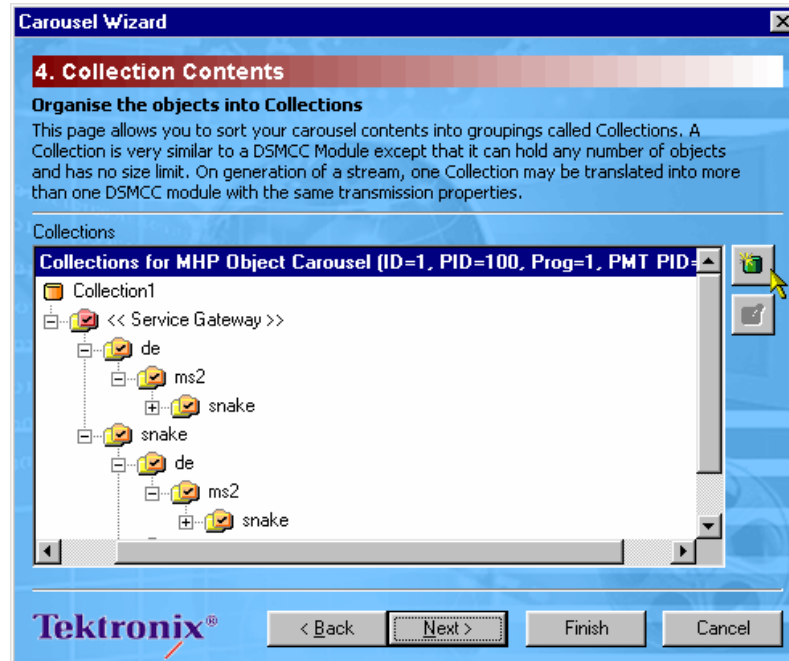

## Step 4: Collection Contents

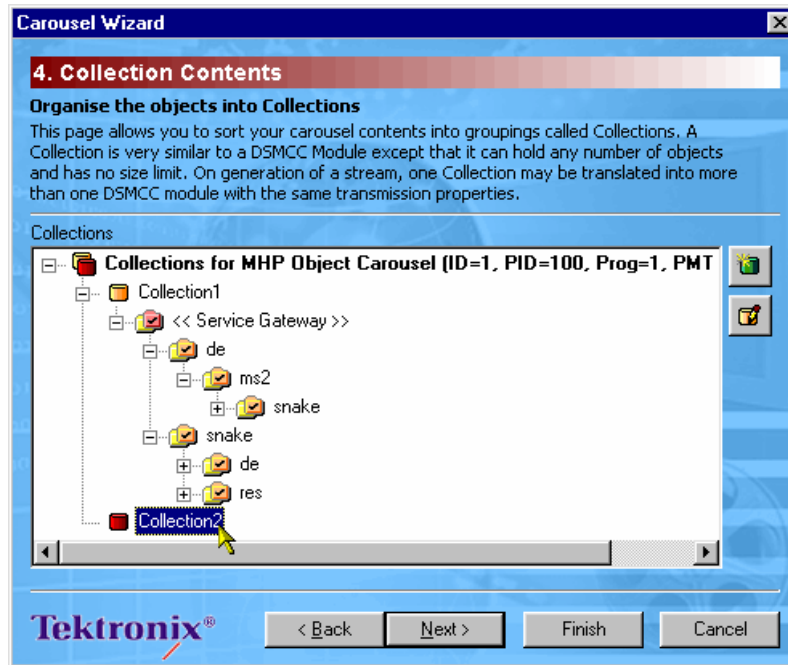

The files added in the previous step are automatically placed in a single default Collection (as shown above). Collections allow objects to share transmission properties including minimum repetition rate (maximum cycle time) and compression. This step allows the user to change the properties of the default Collection, create new Collections, and move files between the various collections.

9. Select  to create a new collection header.



10. Highlight a collection node and select  to modify the collection's properties.

---

**NOTE.** If the previous wizard step is reselected (Back) and more files added or removed, the Collection assignment is maintained for existing files and new files are placed in the parent directory's collection by default.

---

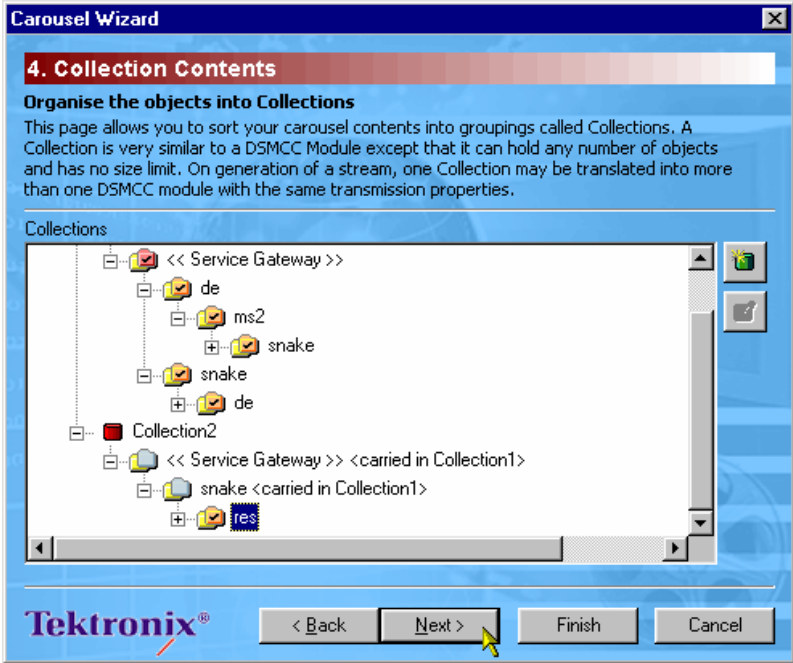



To modify the collection properties, highlight the required Collection node and select Properties from the right-click menu.

- 11. Select Next to display Step 5: Imported Elementary Streams.

## Step 5: Imported Elementary Streams

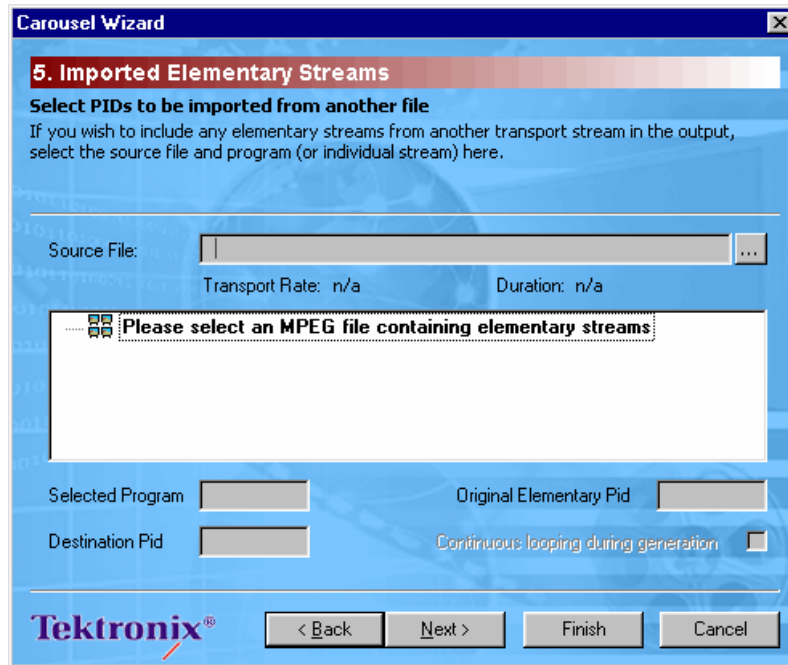
In addition to the carousel objects, elementary streams from a transport stream can be included in the session.



12. Use the Source File:  button to identify and select the transport stream.  
The contents of the source file are displayed.
13. Select one or more elements from this tree to import into the current session, or select a program node to import every element contained by the program.

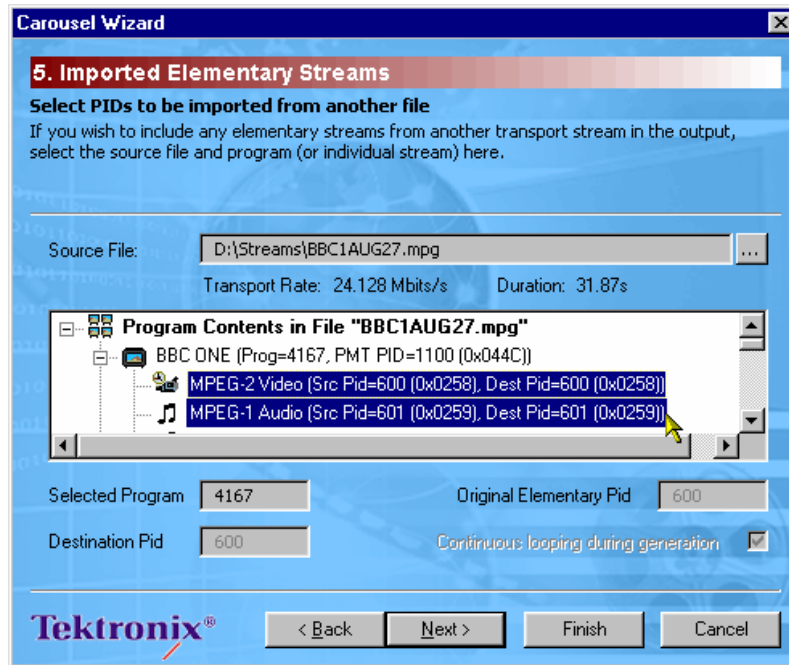

Note that only elements from the same source program can be selected. All elements included in the session will be included in the output stream, whether they are referenced by a program or not.

Where possible, elementary streams will be carried on the same PID used in the source stream; where a conflict within the session occurs, a new PID will be automatically allocated or can be allocated manually.

14. Having identified the source stream and the individual elementary streams to be included in the session, select Next to display *Step 6: Program Entry*.

## Step 6: Program Entry

At this step, a new entry will be created in the PMT referencing this carousel. Also, the elementary streams identified in the previous steps can be associated with a new program.

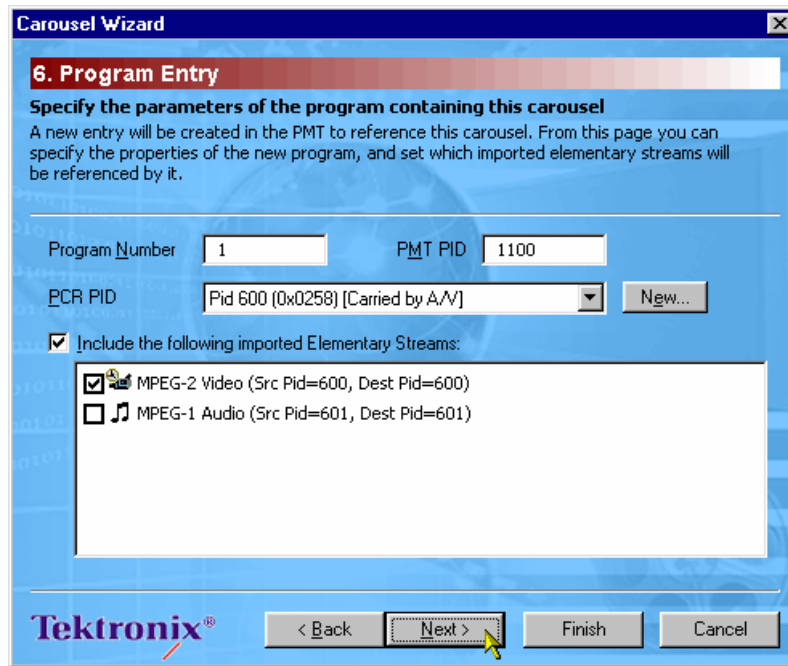

15. Select the elementary streams to be included in the new program.

16. Select Next to display *Step 7: Output Stream Properties*.

## Step 7: Output Stream Properties

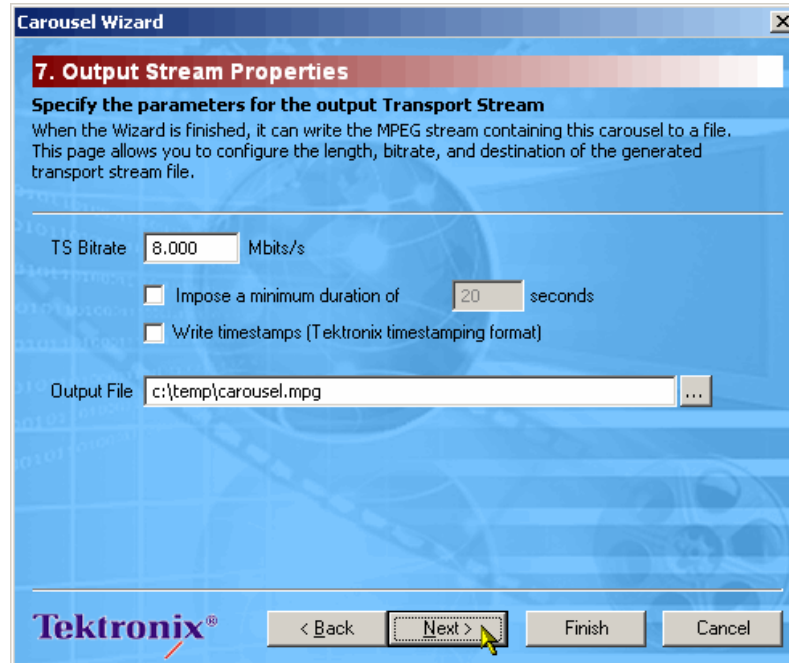

Use this screen to specify the name and properties of the transport stream that is to be created.

17. Enter the TS Bitrate.
18. Enter minimum duration for the output transport stream if required.
19. Enter or select (  ) an Output File name.
20. Select Next to display *Step 8: Congratulations*.

## Step 8: Congratulations

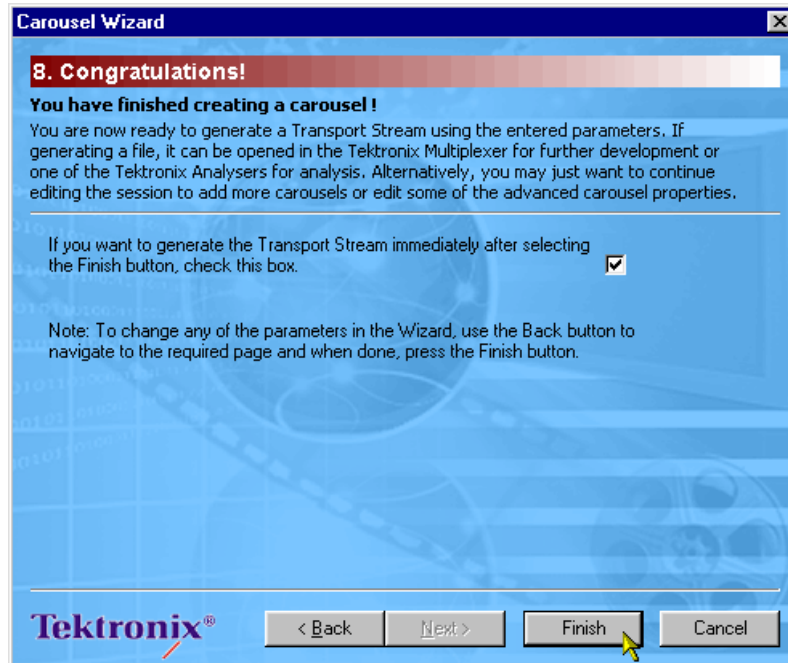

The carousel is now prepared. If the option to create the transport stream is enabled, then all carousels in the current session will be included. The carousel created with the wizard will be added to the session screen.

21. Select **Finish** to exit the wizard.



# Menus and Controls

The following pages contain descriptions of different menu options, toolbar controls, status bar, log window, and properties window.

## Menus Options

The following pages describe all of the menu options. Since many of the options are context sensitive, they will be available only when their function is appropriate for the selected window or display element. When a menu option is not available, the option is grayed out.

### File Menu Options

**Table 7-1: File menu options**

<b>Option</b>	<b>Function</b>
New Carousel Session	Opens a new carousel session. An opportunity to save the current session is offered, if relevant.
Open Carousel Session...	Opens an existing carousel session using a saved carousel definition file.
Save Carousel Session	Saves the current carousel session in the form of a carousel definition file. If the file has not been saved, an opportunity is offered to name it.
Save Carousel Session As...	Allows the current carousel session to be named and saved in the form of a carousel definition file.
Most Recently Used List	Lists the most recently used carousel session files. Click on a file name to reopen it. The number of files displayed is set in the Carousel Generator Options dialog box ( <b>Tools &gt; Options</b> ).
Exit	Closes the application. An opportunity is offered to save the session if it has not been saved.

## Edit Menu Options

**Table 7-2: Edit menu options**

Option	Function
Cut	Cuts the currently highlighted item. The item is stored on the Windows clipboard.
Copy	Copies the currently highlighted item. The item is stored on the Windows clipboard.
Paste	Paste the item currently on the Windows clipboard.
Empty Carousel	(Carousel contents node highlighted.) Deletes the carousel contents.
Delete Collections	(Collection node highlighted.) Deletes the selected collection (The Collection must be empty; the contents must be moved to another collection first).
Delete Program	(Program node highlighted.) Deletes the selected program and the carousel(s) it contains.

## View Menu Options

**Table 7-3: View menu options**

Option	Function
MHP Applications	List MHP applications where they are included in a session.
Carousels; Log; Generator Toolbar; Player Toolbar; Status Bar	Allows the screen elements listed to be shown or hidden.

## Session Menu Options

**Table 7-4: Session menu options**

Option	Function
New Program...	(Program view.) Adds a new program node.
Import Elementary Stream(s)...	(Program view.) Allows elementary streams to be added to the Elementary Streams node.
New Carousel	(Carousel view or Program node.) Allows a new carousel type to be created.
Carousel Wizard	Opens the Carousel Wizard which takes the user through carousel and stream generation step-by-step.
Carousel Properties...	Opens the Carousel Properties dialog box.
Contents	Facilitates the file activities listed below (the menu content is context sensitive): Empty Carousel Empty currently highlighted carousel.
	Delete Object Deletes currently highlighted object (and dependant objects). Add File(s)... Adds one or more files to the selected carousel. Add Directory... Adds a directory to the selected carousel. New Directory... Creates a new directory at the selected node. Move to Collection Moves the selected objects to another collection. HTML Application commands Makes, Removes, and Edits HTML applications. Java Application commands Makes, Removes, and Edits Java applications. These HTML and Java Application commands are only applicable to file objects (when a file is selected).
Synchronize	Synchronizes the carousel contents with the source files.
Delete Carousel	Deletes the selected carousel.
Delete All Carousels	Deletes all carousels in the current session.

## Player Menu Options

**Table 7-5: Player menu options**

Option	Function
Stream Generation Properties...	Opens the Stream Generation Properties dialog box.
Start Payout	Initiates output stream generation using information in the current session.
Stop Payout	Stops output generation.
View Packets/Time	Switches between packet count and time display during payout.

## Tools Menu Options

**Table 7-6: Tools menu options**

Option	Function
Launch Multiplexer	Opens the Multiplexer application.
Launch Carousel Analyzer	Opens the Carousel Analyzer application.
Launch TS Analyzer	Opens the Transport Stream Analyzer application.
Options...	Opens the Carousel Generator options dialog box. This is used to set the basic Carousel Generator and session defaults.

## Help Menu Options

**Table 7-7: Help menu options**

Option	Function
Quick Help	Opens an HTML help page containing summarized help information.
User Guide	Opens the Carousel Generator User Guide in Adobe Acrobat™ (PDF) format.
About Carousel Generator...	Displays information about Carousel Generator, including Software Version and Serial Number. This information will be required if Tektronix support is required.

## Toolbars













Two toolbars can be displayed: Generator and Player. The toolbars can be shown or hidden using the View menu or by right-clicking in the toolbar area.

Toolbars provide a set of convenient shortcuts for the more frequently used menu options. The buttons are context-sensitive and are enabled or disabled dependent upon the currently highlighted view or the action being performed.

### Generator Toolbar







**Table 7-8: Generator toolbar icons**

Icon	Function	Equivalent Menu Bar Command
	Carousel wizard	Session > Carousel Wizard (Ctrl+W)
	New carousel session	File > New Carousel Session (Ctrl+N)
	Open carousel session	File > Open Carousel Session (Ctrl+O)
	Save carousel session	File > Save Carousel Session (Ctrl+S)
	Toggle workspace view	View > Carousels
	Add directory	Session > Contents > Add Directory...
	Add files	Session > Contents > Add Files...
	New collection	(Right-click on Collection node) > New Collection
	Insert program	Session > New Program...
	Synchronize carousel	Session > Synchronise...
	Launch Carousel Analyzer	Tools > Launch Carousel Analyzer
	Launch Multiplexer	Tools > Launch Multiplexer
	Launch Transport Stream Analyzer	Tools > Launch TS Analyzer

**Player Toolbar**



**Table 7-9: Player toolbar icons**

Icon	Function	Equivalent Menu Bar Command
	Playout Carousel	Player > Start Playout
	Stop playout	Player > Stop Playout
 	Toggle Packet/Time display	Player > View Packets/Time

Toolbars can be dragged off the edge of the main window into a floating pallet. To do this, place the mouse pointer on the background inside the Toolbar, (not on one of the buttons), hold the left button down, and drag the toolbar into the main window area. The result is a self-contained window that looks like this:



















To replace the Toolbar on the window border, drag it over the border until the outline changes shape. It can be placed on the top, bottom, left or right edge.

The Toolbar may be hidden from view - **View > Toolbar**.



**Icons.** The icons in Session windows are used to provide the user with a graphical indication of status.

Icons incorporating an arrow indicate a shortcut function; for example, elementary streams displayed in a Program node in the Programs view indicate a shortcut to the elementary stream in the Elementary Streams node.

**Table 7-10: Session icons**

Icon	Function
	Collections node
	Collection node containing the Service Gateway. At least one collection must exist during any session. The collection containing the Service Gateway cannot be deleted.
	Ordinary collection node. Not containing Service Gateway.
	Compressed collection.
	Directory object Included in Carousel; Included in Synchronization.
	Directory object Included in Carousel; Not included in Synchronization.
	Directory object Not included in Carousel; Included in Synchronization.
	Directory object shared.
	File object Included in Carousel.
	File object Not included in Carousel.
	PCR node
	DVB SI / MPEG PSI
	Table node
	Transport Stream node
	Program node
	Carousel object
	Elementary Stream - Audio

**Table 7-10: Session icons (Cont.)**

Icon	Function
	Elementary Stream - Video
	Elementary Stream - Private data

## Log Window

The Log Window contains three tabbed views:



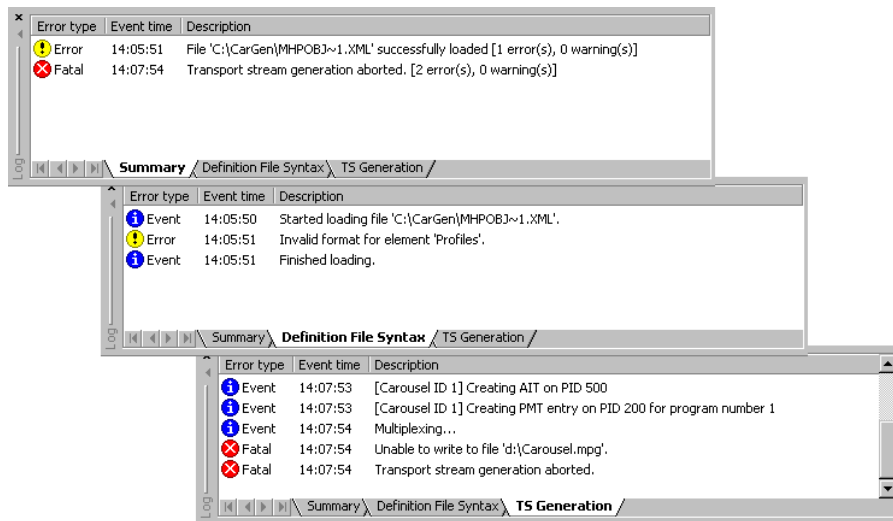

- The **Summary** log records information on the general activities in the Carousel Generator.
- The **Definition File Syntax** log records information on activities concerning the definition file.
- The **TS Generation** log records information during stream generation activities.



During file loading and saving and the generation of transport streams, error messages are routed to the appropriate Log window tab. More information about each error can be accessed by clicking on the error entry or selecting the **Details...** option from the right-click menu.



The following icons are used to indicate the severity of the error:

-  (Blue)    Event            Indicates normal processing activity.
-  (Gray)    Warning           Indicates that information was not available or was invalid. The operation will often be completed.
-  (Yellow)   Error            Indicates that a sub-operation could not be completed; the overall task may still be completed.
-  (Red)    Fatal            Indicates that a fatal error has occurred; an activity has failed to reach completion.

A right-click menu allows the user to clear the displayed log or all logs.

## Status Bar

The Status Bar displays tool-tips when the mouse pointer is over active elements of the window, for example, toolbar buttons and menu options.

## Properties Window (List Control)

In properties windows that display lists (for example, contents lists), one column can be selected to sort the list into ascending or descending order.

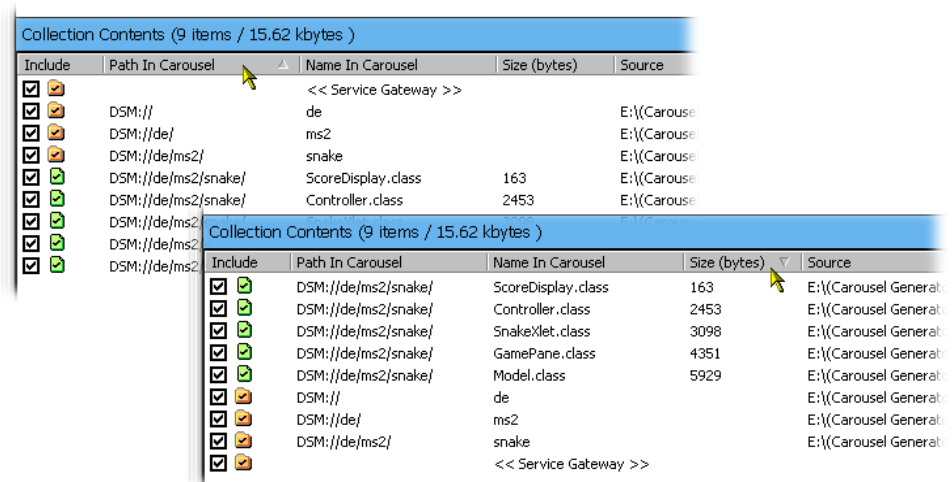

To sort a list, click the key column header. If the same column needs to be sorted in reverse order, click the header again; note that the arrow icon in the header bar indicates the sort direction.



# Carousel Generation

This section describes the processes required to create a transport stream containing one or more carousels. In broad terms it echoes the steps outlined in the Wizard, but more background information is provided.

## Setting Overall Carousel Generator Properties

Although not essential during every session, the general properties of the Carousel Generator can be set using the Carousel Generator Options dialog box. Note that settings such as the Output Filename can be overridden in the current session; however, the settings made here will be used as the defaults in any new session.

Select **Tools > Options...** to open the Carousel Generator Options dialog box.

### **Carousel Generator Options**

The following screens are available in this dialog box: **General**, **New Session Defaults** and **Event/Error messages**. To view a screen, click the name in the left panel.

**General screen**

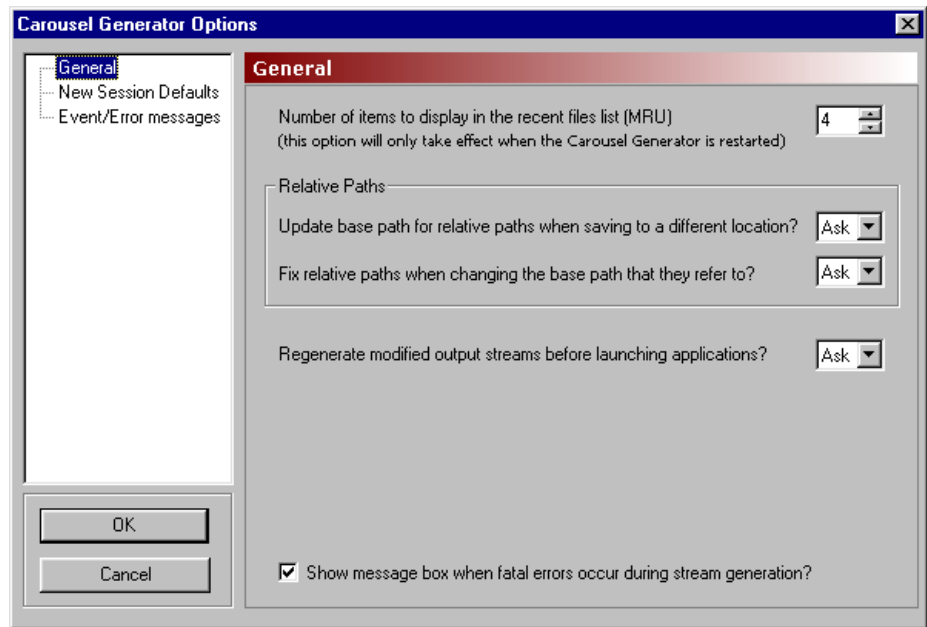

- Number of items...**      A list of the most recently used carousel definition files is displayed in the **File** menu. Use this parameter to select how many file names should be displayed.  
Range: 0 to 15
- Relative Paths**              The paths of source components associated with a carousel file can be stored in relative or absolute format.
- Update base path...**      When a carousel definition is saved to a different (new) location, components stored with paths relative to the original carousel definition may no longer be found at the same (relative) location. If **Yes** is selected from the drop-down list, the base path will be modified so that the components can still be found. Select **Ask** to allow the user to make a decision when the carousel definition is saved. If **No** is selected, no modification will be made to the base path; carousel components may no longer be accessible to the definition file.
- Fix relative paths...**      When the base path for components referenced by a carousel definition file is changed, the existing relative paths may not refer to the correct locations. If **Yes** is selected from the drop-down list, the relative paths will be adjusted so that they are referenced correctly to the new base path.

- Regenerate...**      When enabled, launching Carousel Analyzer, Transport Analyzer or Multiplexer causes the output stream to be regenerated using the current session properties. This ensures that the properties that have been entered in the Carousel Generator are the same as those shown in the Carousel Analyzer, Transport Analyzer or Multiplexer.
  
- Show message...**      When enabled, a message will be displayed during stream generation if an error occurs which causes the stream generation to terminate. The error will always be reported in the TS Generation tab of the Log window.

**New Session Defaults screen**

This screen provides default values to be used for all new sessions and consequently in the carousel definition files and generated transport streams. The default values can originate from a template or be set individually. The values can be overridden in individual carousel sessions.

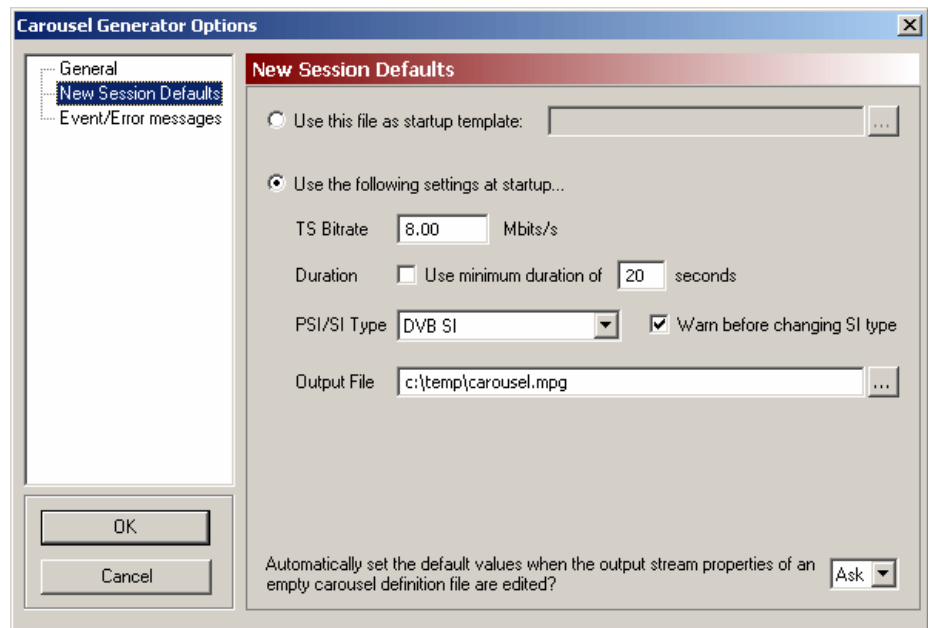

- Startup Template**      Select this option and identify a file to be used as a start-up template.  
  
Any carousel session file (XML format) can be used as a template. It can be used primarily to retain settings which are required from session to session, for example, network settings.

**Startup Settings.** Select the **Use the following settings...** option to set the session defaults locally.

**TS Bitrate:** The bit rate of the output transport stream.  
Range: 0.25 Mbit/s to 90 Mbit/s

**Duration:** The duration value (in seconds) available when this feature is enabled will dictate the minimum length of the transport stream.

**PSI/SI Type:** This selection will dictate the tables that are automatically created at startup.

If **MPEG PSI** is selected, only the PAT and PMT will be generated. If **DVB SI** is selected, the mandatory DVB tables (NIT actual, TDT, SDT actual and EIT P/F actual) will also be generated.

Select the **Warn before...** checkbox to display a message when a change to the Stream Generation PSI/SI Type property is attempted (see page 7–40).

#### **Output Settings.**

**Output File:** Enter the filename to be used in generating an output transport stream or browse to find an existing filename.

#### **Automatically set the default values...**

If at the start of a session (with no carousels defined), changes are made to the *Stream Generation Properties* (see page 7–40), whether or not the changes are saved as Carousel Generator defaults is dictated by this setting.

The options operate as follows:

**Ask:** The dialog box shown below will allow the user to choose between using the revised settings as future defaults or to only use them for this session.

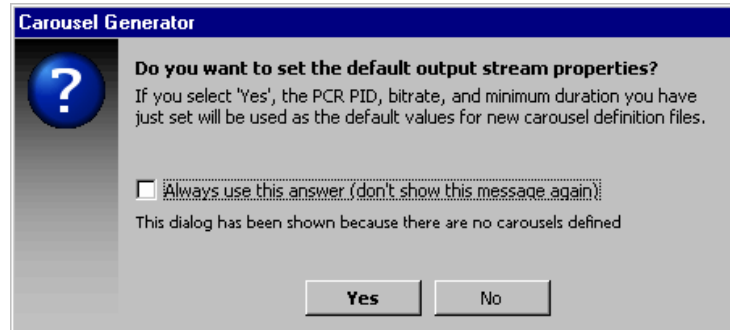

If the **Always use...** checkbox in the dialog box is enabled, the **Automatically set...** option in this screen will be reset to concur.

**No:** The revised settings will not be used as future defaults.

**Yes:** The revised settings will be used as future defaults.

### Event/Error Messages screen

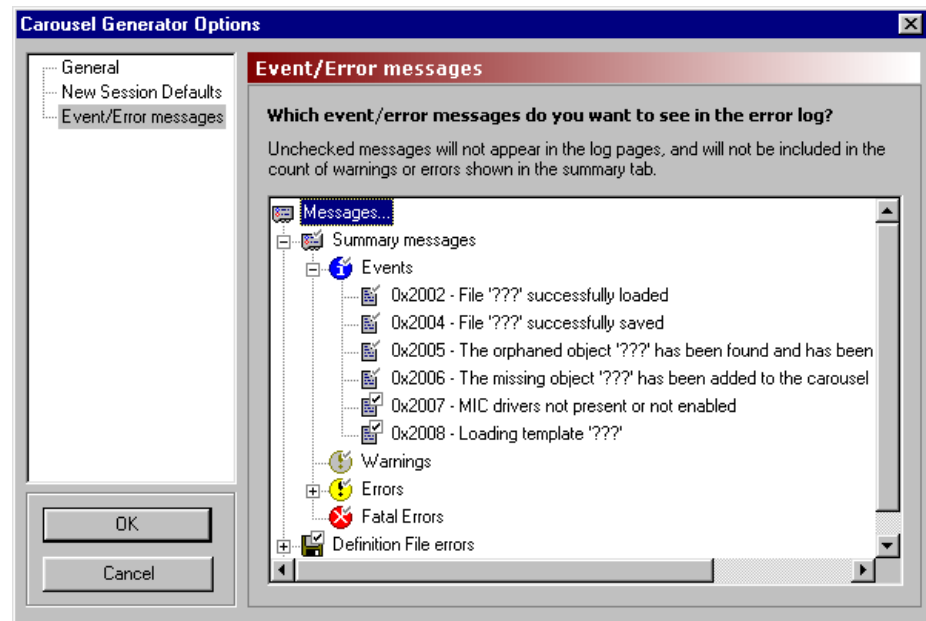

The Log view, which can be displayed as part of the main application, displays a series of status and error messages, which advise the user of the progress of carousel and stream generation.

This screen allows the user to indicate which messages should be displayed. The Log view contains three tabbed screens: Summary, Definition File Syntax and TS Generation. These correspond to the message categories Summary messages, Definition File errors and TS Generation errors in this screen.

Each message category contains four levels of severity: Events, Warnings, Errors and Fatal Errors. Individual messages that can be displayed in the Log view are listed at each level.

**Message Selection.** The checkmarks associated with each message icon indicate the reporting status of the message.



Enabled (permanent): this message type will always be reported in the log view.



Enabled / disabled (toggle): this message type is enabled/disabled by the user. It will only be reported in the log view when enabled.



If one or more of the subsidiary message types in a category (Events, Warnings Errors) is disabled, this icon is displayed.

All messages in the Summary category and Fatal Error messages in all categories are all permanently enabled; they cannot be disabled. The remaining messages in the Carousel Definition File and Stream Generation categories can be enabled and disabled as required by clicking on the message icon.

A brief description of a message can be displayed by clicking on the message name.

(See also *Log Window*, page 7–30.)



## Creating a Session

A session in Carousel Generator is the activity during which objects are assembled in one or more carousels with a transport stream being the end result.

The initial activity when starting a session is to note the defaults that are already displayed in the Stream Generation Properties screen; these are derived from the Carousel Generator Options. If required, the values can be modified for the current session.

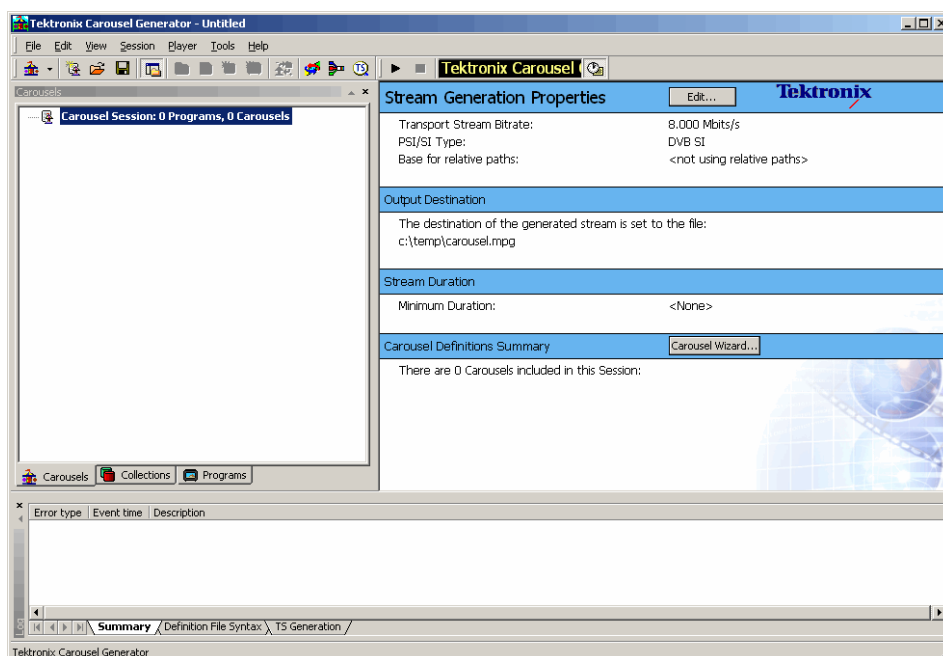

The values may be changed at any time in the session; it may be useful to review these settings at the end of a session, before the transport stream is created.

Select **Player > Stream Generation Properties...** to open the Stream Generation Properties dialog box or select **Edit...** in the properties window or double-click in the properties window.

**Stream Generation Properties**

This screen provides stream generation values to be used in the current session.

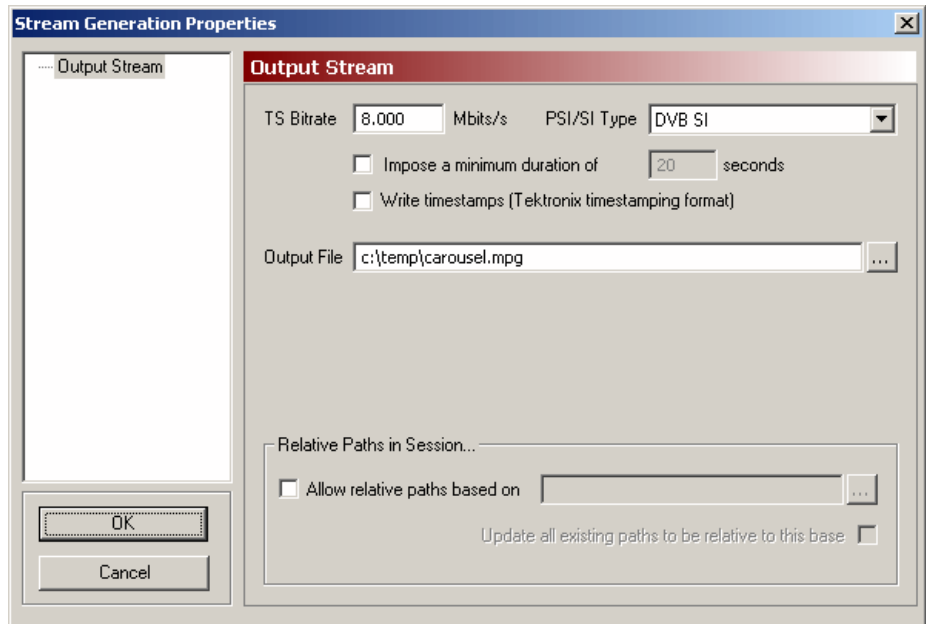

- TS Bitrate:** The bit rate of the output transport stream.  
Range: 0.25 Mbit/s to 90 Mbit/s.
- PSI/SI Type:** This selection will dictate the tables that are created in the generated stream. If MPEG PSI is selected, only the PAT and PMT will be present. If DVB SI is selected, the mandatory DVB tables (NIT actual, TDT, SDT actual, and EIT p/f actual) will also be generated.  
  
A warning may be issued noting that SI settings may be lost (see *New Session Defaults Screen*, page 7–35).
- Output File:** Enter the name and path of the output file. Select to specify a location on local or network drives.
- Relative Paths in Session...**  
The paths of source components associated with a carousel file can be stored in relative or absolute format.

**Allow relative paths based on**

When enabled, Carousel Generator will interpret all incomplete paths as being relative to the base path specified in the adjacent text box.

The specified base path can be an absolute path (such as c:\data) or it can be relative to the current location of the carousel definition file. Note that if '.' is entered in the box, all relative paths are referenced to the current location of the carousel definition file.

Any automatically created paths will also be made relative to the base path, if possible.

If the checkbox is cleared (disabled), only absolute paths will be used.

**Update all existing...** When enabled, Carousel Generator will attempt to convert all paths used in the session to be relative to the specified base path (where possible).

If the checkbox is cleared (disabled), existing absolute paths will be left unchanged.

## Selecting the Carousel Type

There are a number of carousel types available from the various standards authorities. Carousel Generator makes available the types listed in the following table:

<b>Carousel Type</b>	<b>Guiding Standard</b>
DSMCC Object	ISO/IEC 13818-6: 1998 (MPEG)
DVB Object	DVB EN301 192 V1.2.1
DTT Object	DTG DTT Requirements for Interoperability V3.1
MHP Object	ETSI TS101 812 V1.1.2 & V1.1.1

Select **Session > New Carousel** and click on the required carousel type. A new (empty) carousel of the required type will be added to the session. The carousel will be assigned an identity number (ID) and allocated to a PID automatically.

Additional carousels can be added; successive IDs and PIDs will be allocated.

## Modifying the Carousel Properties

The properties of individual carousel can be modified as required. A summary of the carousel properties is displayed in the Properties window.

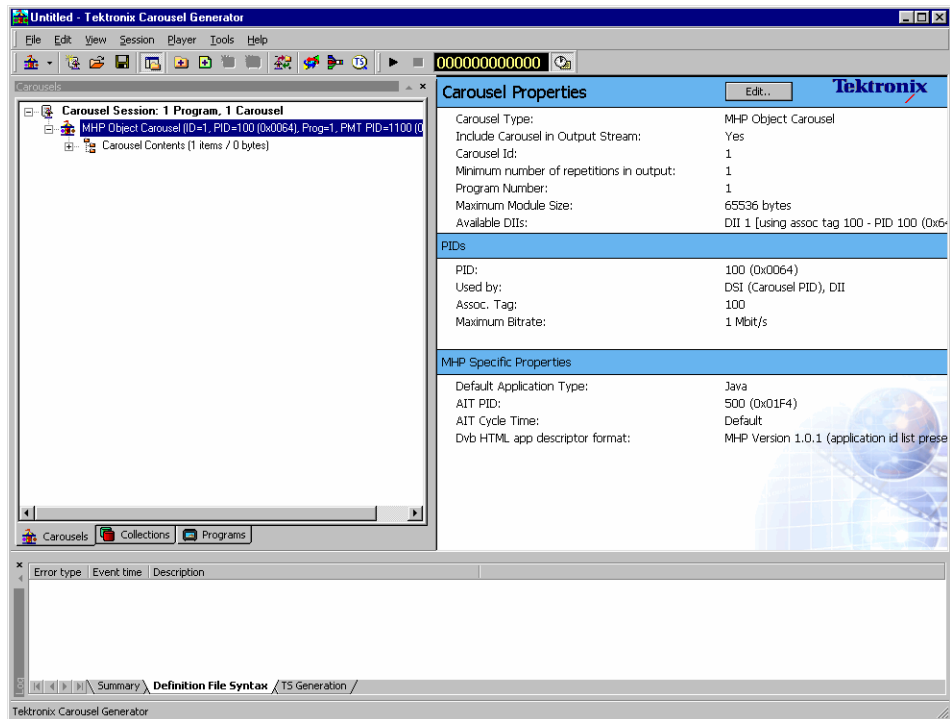

The contents of the carousel are displayed when the Carousel Contents node is highlighted.

To edit individual carousel properties, in the Carousels tab of the Sessions window and with the carousel node highlighted, select **Session > Carousel Properties...** or select **Edit...** in the Properties window. The Carousel Properties dialog box is displayed.

The number of screens available in the Carousel Properties dialog box is dependent on the carousel type selected. In the following notes, screens dedicated to only a single carousel type are identified; all other screens are common to all types.

The Carousel Properties dialog box can display up to four screens: General PID settings, DSI/DII settings, DTT Applications (DTT only), and MHP (MHP only).

**General screen**

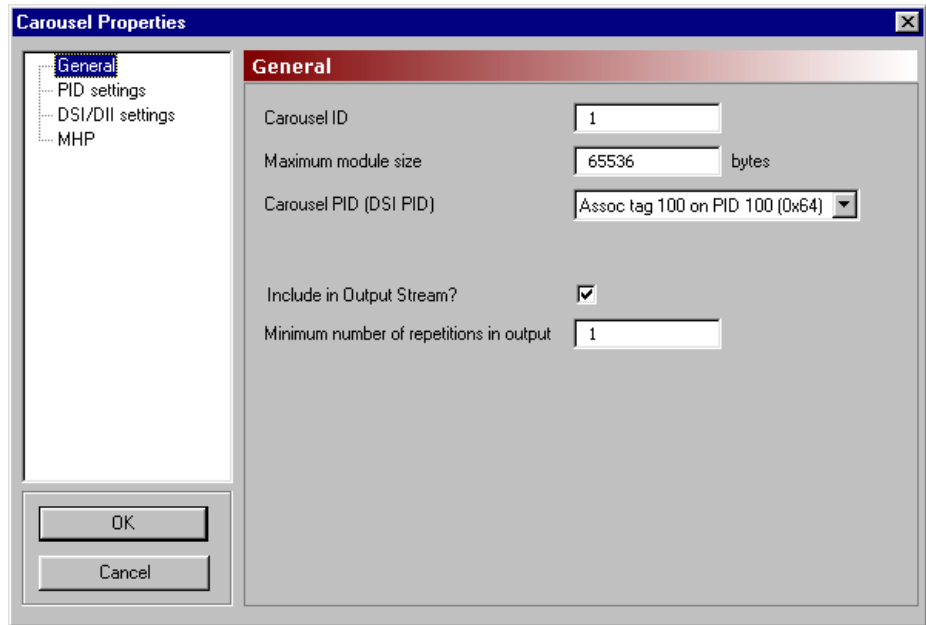

- Carousel ID:** Unique carousel identity. The Carousel ID is normally generated automatically but can be changed by the user.  
Range: 0 to 4294967295
- Maximum module size:** The maximum size of the modules used to carry the carousel objects. During output stream generation, if a module has one or more objects and does not have enough space for the next object, a new module will be created. If a module is empty and the object added will exceed the maximum size, the object is still added, but no more objects will be placed in that module.  
Range: 0 to 4294967295 Default: 65536
- Carousel PID (DSI PID):** Select the required Association Tag from the drop-down list.  
During carousel creation, a default Association is generated to carry the Carousel/DSI PID. This cannot be removed.
- Include in Output...** This flag allows the carousel to be included in or excluded from the output stream. If the checkbox is disabled, no reference to this carousel or its contents will appear in the generated output stream.

**Minimum number...** Enter the minimum number of times that the carousel is to appear in the output stream; this can be repeated for each carousel in the session. The resulting output stream will be long enough to accommodate at least the minimum number of repetitions requested for each carousel.

**PID settings screen**

The tree structure in the PID Settings screen shows the PID usage for the selected carousel’s program. The DSI and DII messages carried in the carousel use an Association tag, which allows the BIOP messages in the carousel to be linked to a PID in the stream (see “BS ISO/IEC 13818-6:1998 Information Technology - Generic coding of moving pictures and associated audio information - Part 6: Extensions for DSM-CC).

To place the DII and DSI messages on different Association Tags, use the DSI/DII settings screen (see page 7–46).

During stream generation, each Association Tag specified will result in the following:

- An elementary stream (ES) with a stream type of 11 (DSMCC U-N messages) and the entered PID being added to the PMT ES loop.
- The Association Tag value will be inserted into an `association_tag_descriptor` inside this ES’s descriptor loop.

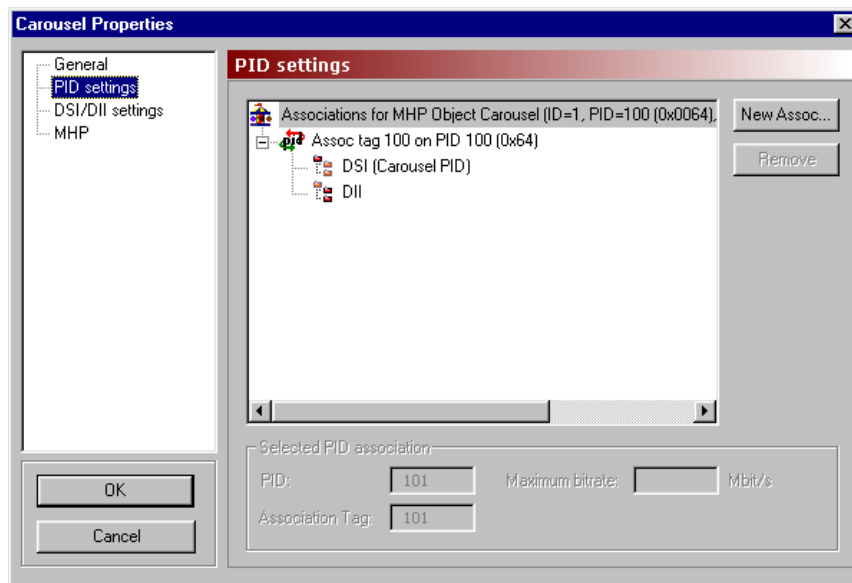

Highlighting any of the association nodes will display the PID associations in the Selected PID association panel.

Select New Assoc... to create a new association node in the tree. The PID and Association Tag will be automatically allocated, but they can be changed in the Selected PID association panel.

### Selected PID association

- PID:** This is the PID of the elementary stream (ES) carrying the DII and/or DSI messages.  
Range: 0 to 8191 (see *PID Values*, page 7–45).
- Association Tag:** This is the 16 bit value carried in the association\_tag\_descriptor which is inserted in the ES descriptor loop of the PMT signaling this carousel.  
Range: 0 to 65535
- Maximum bitrate...** This is the maximum bit rate allocated in the stream for this PID. If there is not enough bandwidth to support this rate, the actual bit rate will be less.  
Range: 0.25 Mbit/s to 90 Mbit/s

**PID Values.** As stated, the valid range for PIDs is 0 to 8191. However, there are a number of restrictions on the actual values that can be used, since some are reserved or may be used in other carousels. The following table shows the elements that can and cannot share PID values. Unless otherwise noted, “No” indicates the entities in the row and column headers may not share a PID value in any carousel in a single session. ‘Yes’ indicates that the PID value may be shared with other entities in the same session; unless otherwise indicated in the Notes below.

	Reserved	PCR	PMT	AIT	DSI	DII
DII	No	No	No	No	Yes (Same as Carousel)	Yes (Same as Carousel)
DSI	No	No	No	No	No	-
AIT	No	No	No	No	-	-
PMT	No	No	Yes	-	-	-
PCR	No	No	-	-	-	-
Reserved	No	The Reserved PIDs are PIDs 0 to 31 (0x00 to 0x1F) and the Null PID 8191 (0x1FFF)				

**NOTE.** PIDs 0 to 15 (0x0000 to 0x000F) are reserved by MPEG; PIDs 16 to 31 (0x0010-0x001F) are additionally reserved by DVB.

PMTs cannot share PIDs with anything but other PMTs. Multiple PMT sections can be on the same PID, so, if required, every carousel could have its PMT entry on the same PID (usually not done that way, but it can be).

The DIIs belonging to a single carousel can be on the same PID as its DSI or its other DIIs, but not on the same PID as DSIs or DIIs belonging to other carousels.

For example, the yes/no indicators in the PMT row/column indicate that the value of the PID carrying a PMT may not be shared with any other entities in the session. However, in the case of the PMT, see the above note.

**DSI/DII settings screen**

The tree structure in the DSI/DII Settings screen shows the DSI and DIIs that will be generated in the stream for the selected carousel. Each DSI/DII has an Association Tag and a cycle time, and DIIs have a user definable name.

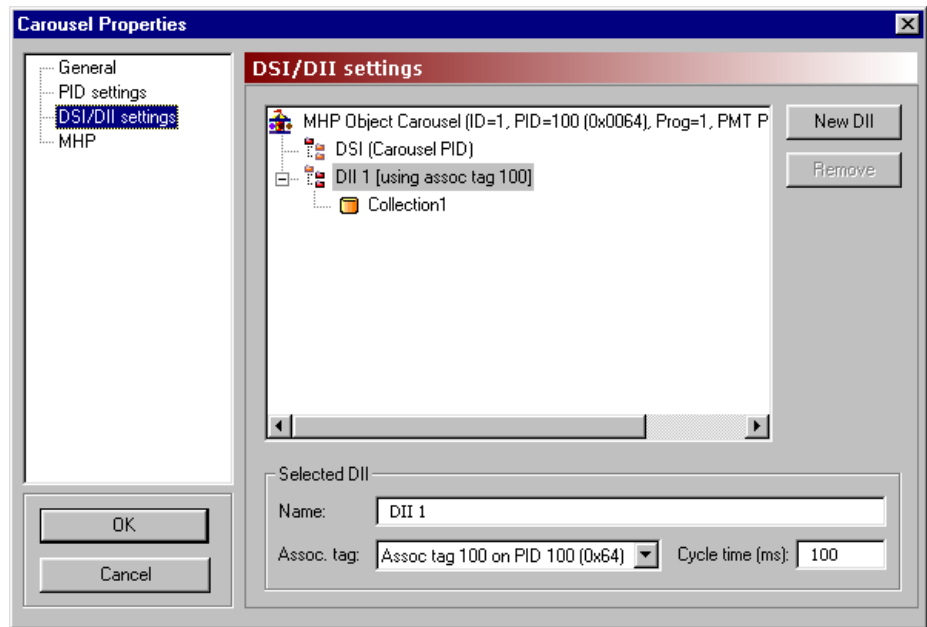

Highlighting any of the DII nodes will display the PID associations in the **Selected DII** panel.

Select **New DII** to create a new DII using default values. The default Association Tag to use is decided by first checking if an existing DII uses the DSI tag. If so, this tag is used, otherwise the tag of the first DII in the list is used.



## Selected DII

- Name:** This is a user allocated name for this DII. The name does not appear anywhere in the generated stream, only within the Carousel Generator.
- Assoc. tag:** This is the list of all the currently defined Association tags listed for this carousel. Assigning a different Association Tag to the DII effectively changes the PID that the DII messages will be carried on.  
(Association tags can be added from the PID Settings screen.)
- Cycle time (ms):** This option sets the time taken for this DII to be repeated. For example, DIIs referencing boot classes may be given shorter cycle times to speed up the boot process.  
Range: 1 ms to 3600 s.

To associate a collection with a DII, first create the DII, giving it a meaningful name, set the Association tag and Cycle time of the DII and close this dialog box. On the Collections tab of the Session window, edit the collection's properties to set the field **Using DII** to the new DII.

**MHP**

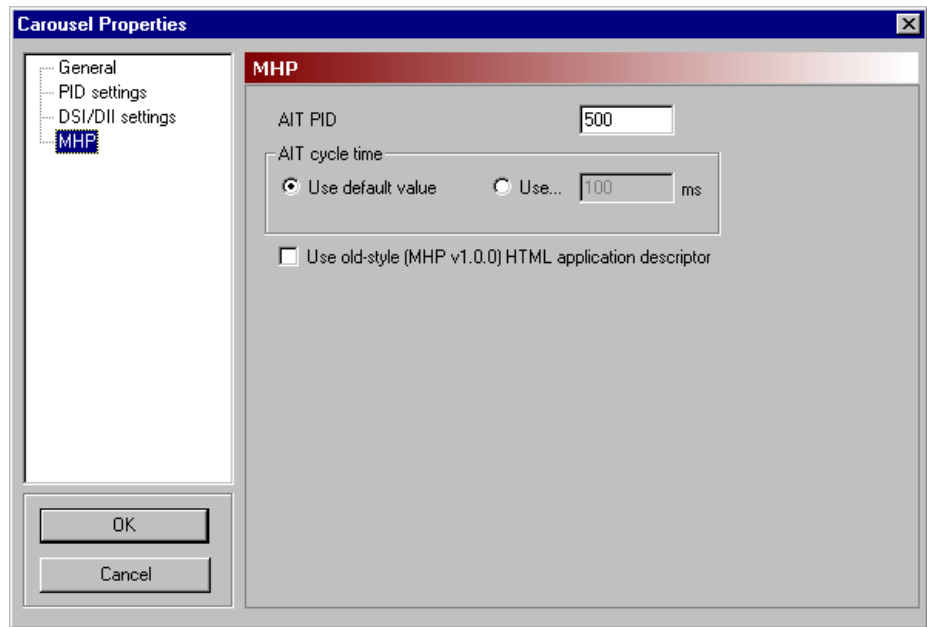

**AIT PID**

This is the PID that carries the Application Information Table (AIT).  
Range: 0 to 8191 (see *PID Values*, page 7–45).

**AIT cycle time:**

Set the time to be taken for the selected Carousel’s AIT to be repeated. Default: 100 ms.

**Use...** Select this option to allow the AIT cycle time to be set manually. Range: 1 ms to 3600 s.

**Use old-style...**

If this box is checked, the DVB-HTML application descriptor format as defined by MHP v1.0.0 (see MHP; ETSI 101812, Version 1.1.2 and 1.1.1) will be used.

If this box is not checked, the new format as defined in MHP v1.1.2 (see MHP; ETSI 101812, Version 1.1.2 and 1.1.1) will be used. This will cause the DVB-HTML Application Descriptor to be properly formed and include an empty set of application IDs. To add application IDs to this descriptor, use the HTML Properties page on the MHP File Properties dialog box.

## DTT Applications

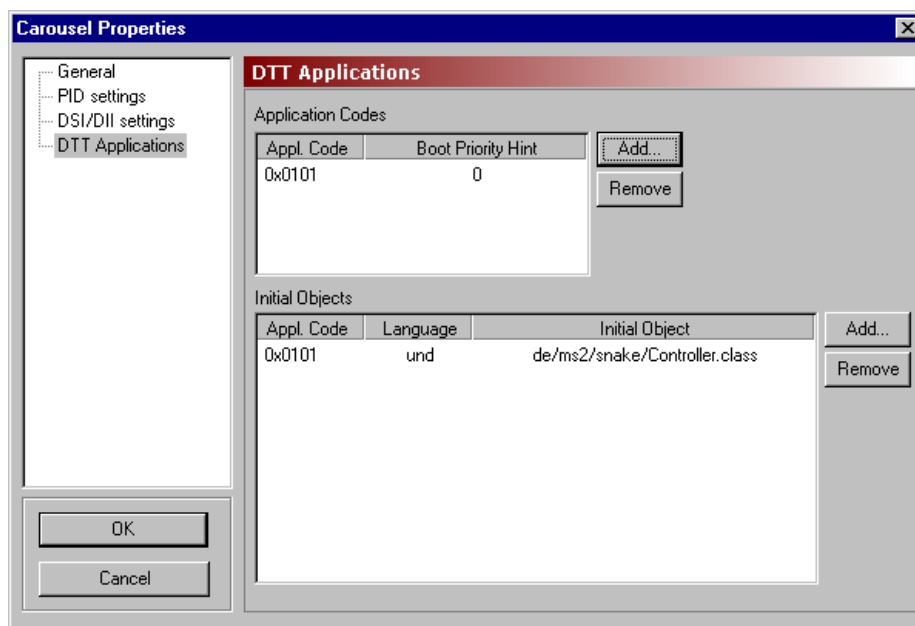

**Application Codes.** The entries in this list will be added to the data\_broadcast\_id\_descriptor in the elementary stream descriptor loop of the PMT. This descriptor lists the application types that can be booted from the elementary stream with which it is associated. The Boot Priority Hint is an indication of the application that should be booted in the case of more than one in the list being supported. The application with the highest Boot Priority Hint, in the range 0 to 255, will be booted first.

**Add** Displays the **Add Application Code** dialog box.

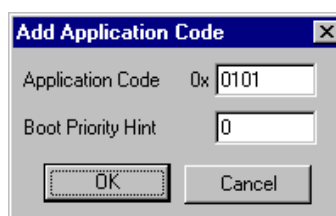

**Remove** Removes the highlighted Application Code.

**Initial Objects.** The Initial Object list allows different languages to have different boot objects. On stream generation, entries here will appear in the ServiceContextList part of the Service Gateway object.

**Add** Displays the **Add Initial Object** dialog box.

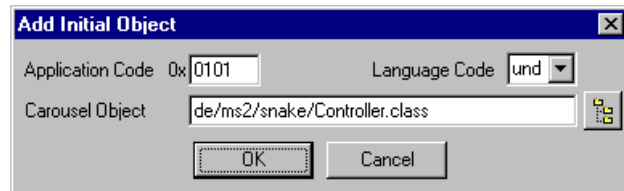

The **Application Code** should correspond to a code that is already listed in the **Application Codes** panel. A **Language Code** can be selected from the drop-down list. The object can be given a name in the **Carousel Object** field. If objects have already been associated with the carousel, the adjacent button will display the contents of the carousel, from which an object can be selected.

**Remove** Removes the highlighted Initial Object.

## Carousel Contents

Each carousel initially contains two subnodes: Carousel Contents and Service Gateway. The carousel will eventually contain all of the objects associated with a particular function or feature. These objects can be arranged in a hierarchy of directories and files all displayed beneath the Service Gateway node.

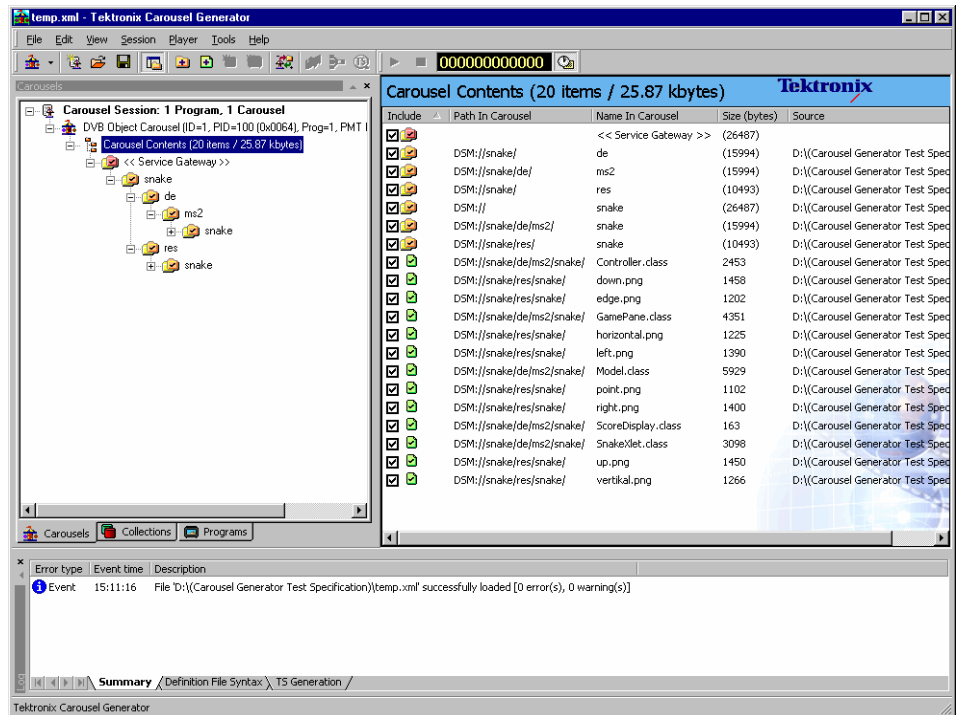

Files and directories can be manipulated in a variety of ways:

- All commands are accessible via the Menu Bar or context sensitive right-click menus.
- Files and directories can be dragged and dropped within Carousel Generator.
- Files and directories can be dragged from Windows Explorer.

The properties of files and directories can be edited after they have been incorporated into a carousel.

### **Adding an Object (File/Directory)**

Individual files or complete directory structures can be added to a carousel. New directories can be created.

The location that an object is to be added to should be highlighted.

#### **Adding Directories.**

1. Highlight the node in the carousel where the directory is to be added.

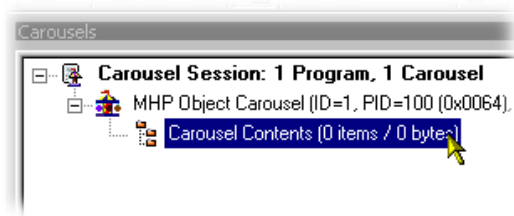

2. Select **Carousel > Contents > Add Directory...**

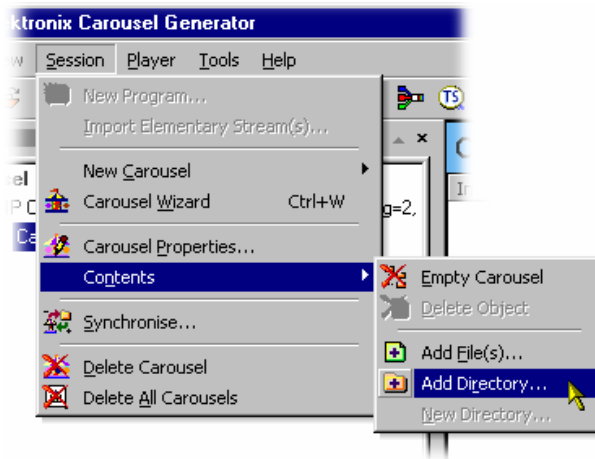

The **Add Directory** dialog box is displayed.

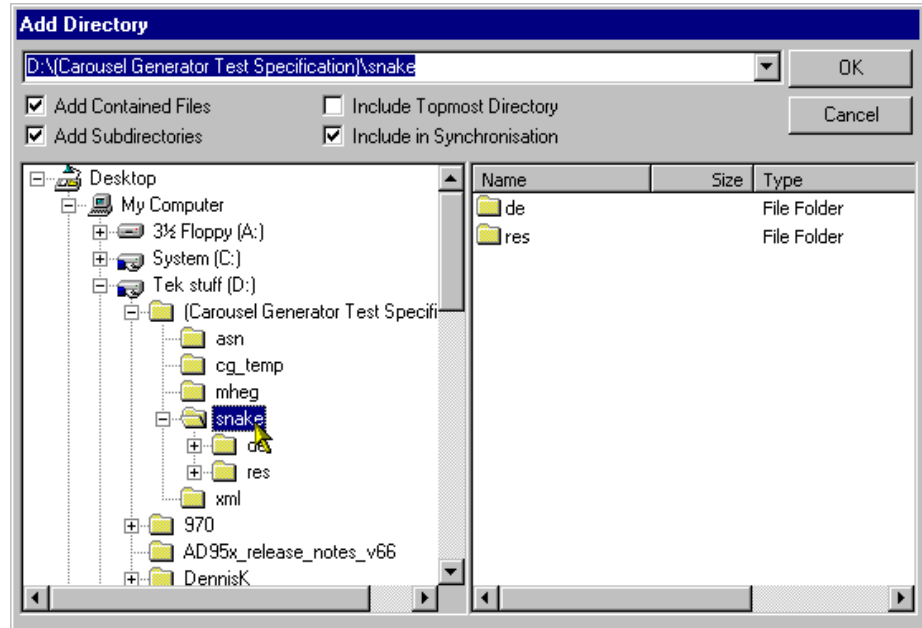

The **Add Directory** allows the user to select any available directory. The directory path is shown in the top field; the most recently accessed directories are available in the drop-down list. The adjacent checkboxes have the following functions:

**Add Contained Files:** All files contained in the selected directory (and any subdirectories if **Add Subdirectories** is enabled) will be added to the carousel.

**Add Subdirectories:** All subdirectories of the selected directory will be added to the carousel.

**Include Topmost Directory:** The selected directory will be added to the carousel (not just the files and/or subdirectories).

**Include in Synchronization:** The selected directory will be synchronized with its source directory (see page 7–65).

3. Select the required directory and enable the required checkbox options. Select **OK** to add the directory to the carousel.

4. The new directory is added below the highlighted node.

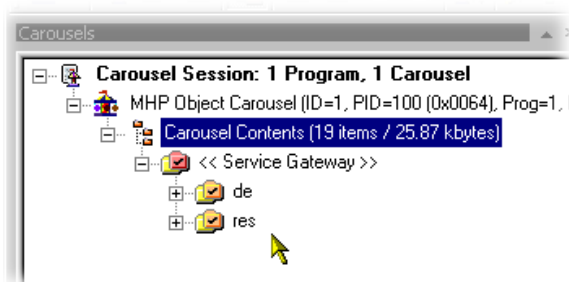

---

**NOTE.** When directories are dragged and dropped from Windows Explorer, all subdirectories and files will be included. If the Shift key is held down during this action, the topmost directory name is not included.

---



### Adding Files.

1. Highlight the directory node in the carousel where the file is to be added.

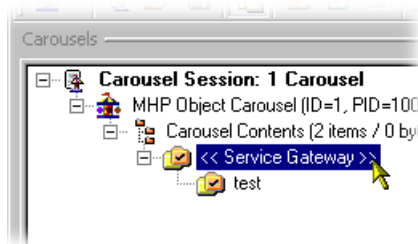

2. Select **Carousel > Contents > Add file(s)...**

The **Select File(s) to Add** dialog box is displayed.

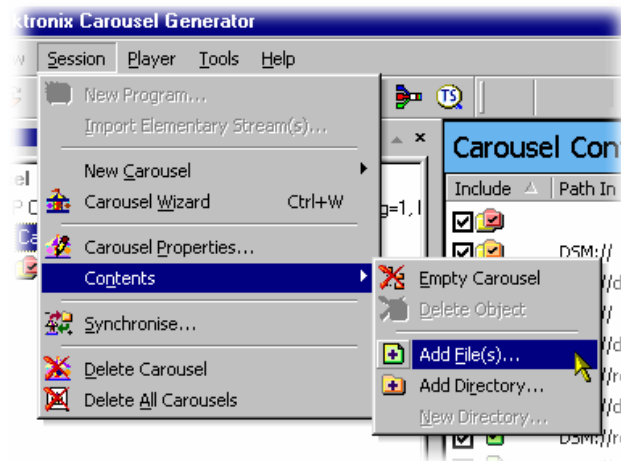

3. Select the file(s) to be added.

4. Select **OK** to add the files to the carousel.

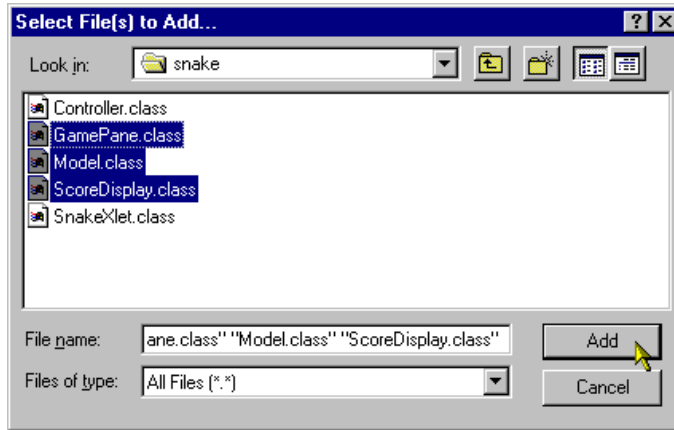

5. The new file(s) are added to the selected directory node.

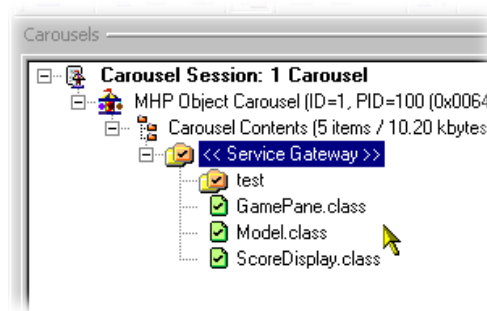

**Creating a New Directory.**

1. Highlight the node in the carousel where the directory is to be created. (In this screenshot, the new directory is the first object to be created.)

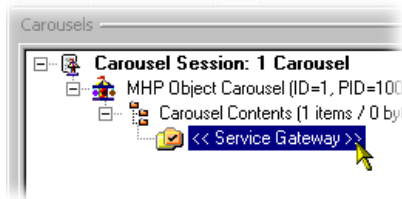

2. Select **Carousel > Contents > New Directory...**

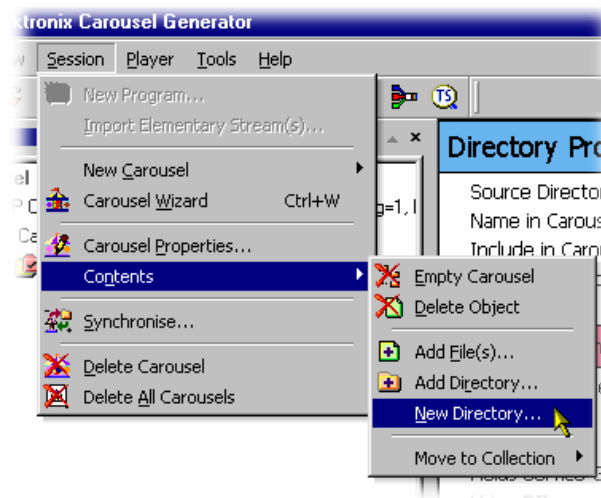

3. Enter the name of the new directory and select **OK** to create the directory.

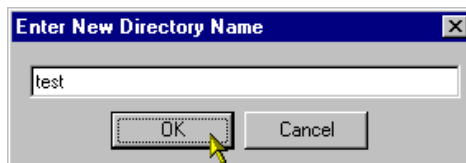

4. The new directory is created below the highlighted node.

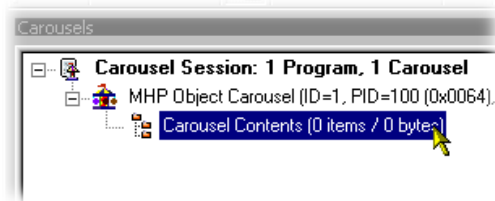

### Moving an Object

Files and directories are moved within a carousel using standard Windows commands and techniques, such as Copy, Cut and Paste and Drag, and Drop.

### Removing an Object

Files and directories are removed from a carousel using standard Windows commands and techniques.

### File Properties

When a file is highlighted, the properties of that file are summarized in the Properties window. The properties can be viewed in detail and edited by selecting **Edit...** and displaying the **File Properties** dialog box.

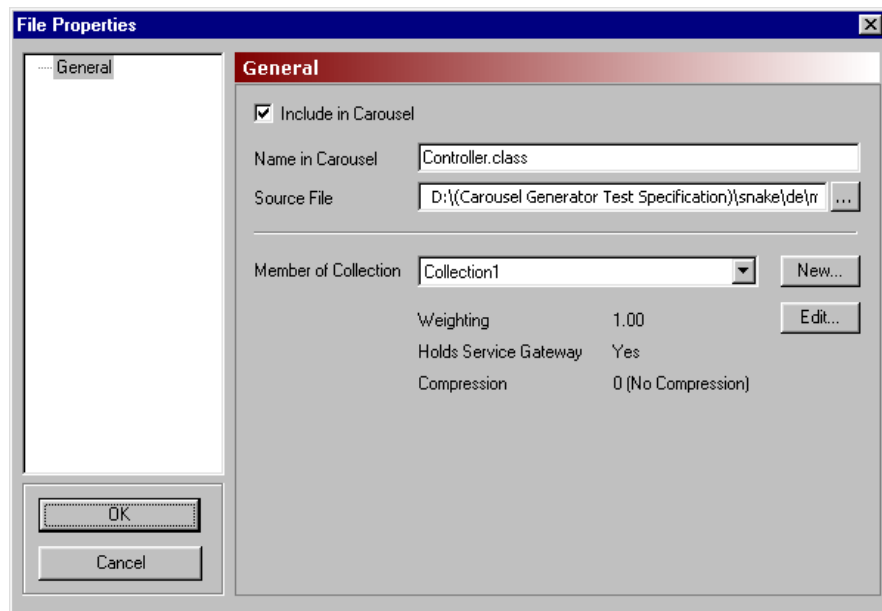

The File Properties dialog boxes for files contained in all types of carousel are similar. However, for the MHP carousel type, if a file is designated as an application (Java or HTML), there are additional properties; these are described in the following sections.

- Include in Carousel:** If this box is checked, the file object will be included in the generated carousel. If not checked, the file object will not be included in the generated carousel.
- Name in Carousel:** This is the name of the object as it will appear in the BIOP message in the output stream.  
 Range: 254 characters maximum (specified by the DSMCC specification. Additional characters will be truncated.)  
 ASCII character set excluding: \ : / \* ? " < > |.
- Source File:** This field is set when the object is added to the carousel and can be edited to point to another object if required. This field does not appear in the output stream and is limited to 260 characters.
- Member of Collection:** This is a list of all the collections currently included in this carousel. Selecting a different collection effectively put this object into a different module possibly with different cycle times and compression characteristics. In the case of a directory object, all child objects below it are also moved to the selected collection.
- New** Create a new collection (see page 7–66).
- Collection Properties:** Displays a summary of the properties of the collection that the object is a member of. The properties can be edited by using the **Edit...** button to open the collection Properties dialog box (see page 7–68).

## Directory Properties

When a directory is highlighted, the properties of that directory are summarized in the Properties window. The properties can be viewed in detail and edited by selecting **Edit...** and displaying the **Directory Properties** dialog box.

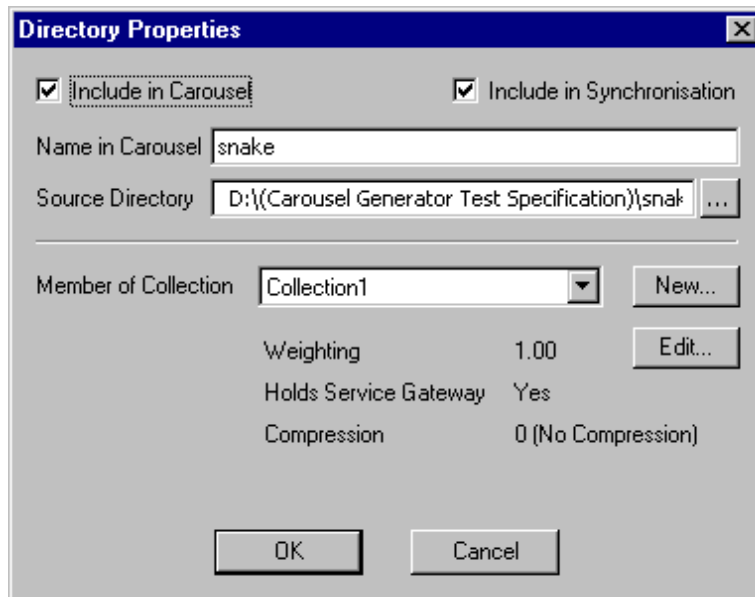

**Include in Carousel:** If this box is checked, the directory object will be included in the generated carousel. If not checked, the directory object will not be included in the generated carousel.

### Include in Synchronization

If this box is checked, the source directory will be included in the Synchronization process which aims to match the source directory structure with the carousel structure, removing and adding file and directory objects as necessary.

If this box is cleared, this directory will not be compared to the source directory and neither will any subdirectories, regardless of their individual settings.

**Name in Carousel:** This is the name of the object as it will appear in the BIOP message in the output stream.

Range: 254 characters maximum (specified by the DSMCC specification. Additional characters will be truncated);

ASCII character set excluding: \ : / \* ? " < > |.

**Source Directory:** This field is set when the directory is added to the carousel and can be edited to point to another directory if required. Newly created directories may not initially have a correct source directory, but this can be edited if desired. This field does not appear in the output stream and is limited to 260 characters.

The Source Directory will be used when the carousel is synchronized only if the **Include in Synchronization** box is checked (see also page 7–65).

**Member of Collection:** This is a list of all the collections currently included in this carousel. Selecting a different collection effectively put this object into a different module with possibly different cycle times and compression characteristics. In the case of a directory object, all child objects below it are also moved to the selected collection.

**New** Create a new collection (see page 7–66).

**Collection Properties:** This panel displays a summary of the properties of the collection of which the object is a member. The properties can be edited by using the **Edit...** button to open the Collection Properties dialog box (see page 7–68).

## Applications

In MHP, applications are transmitted in object carousels. Applications can be written in Java or HTML. All files that make up the application should be added to the carousel. However, the receiver must be made aware of the entry point into the application and certain other information about the characteristics of the application. This information is sent in the Application Information Table (AIT), which the receiver must process before it can start any application.

To define an application entry point and other application information, highlight a file and select **Carousel > Contents > Make Java Application** or **Make HTML Application**. The **Application Properties** dialog box will be displayed. The components of the Application Properties screens are described in the following paragraphs. Note that when the file properties of an application are viewed, the File Properties **General** screen is also displayed.

**Application Descriptor screen.** The Application Descriptor screen is common to both Java and HTML applications.

All the properties on this screen are described in the Application Signaling section of the MHP specification; TS 101 812 v1.1.1, Section 10, Application Signaling.

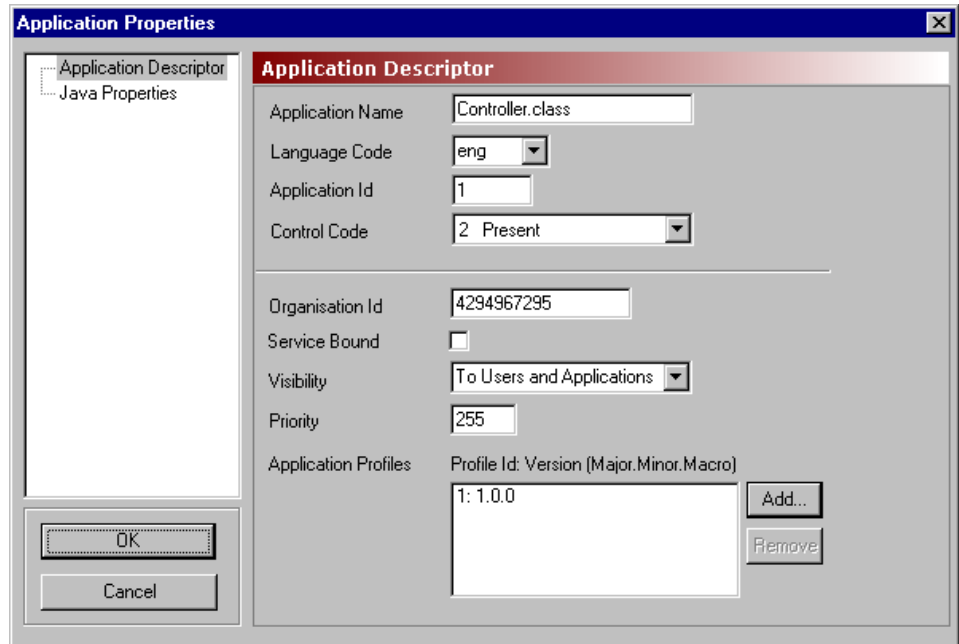

Application Descriptor Name	TS 101 812 identity
Application Name:	Application Name Descriptor
Language Code:	Application Name Descriptor
Application ID:	Application Identifier
Control Code:	application_control_code
Origination ID:	Application Identifier
Service Bound:	Application Descriptor
Visibility:	Application Descriptor
Priority:	Application Descriptor
Application Profiles:	Application Descriptor



**Java Properties screen.** All the properties on this screen are described in the DVB-HTML Specific descriptors of the MHP specification; TS 101 812 v1.1.1, Section 10, Application Signaling.

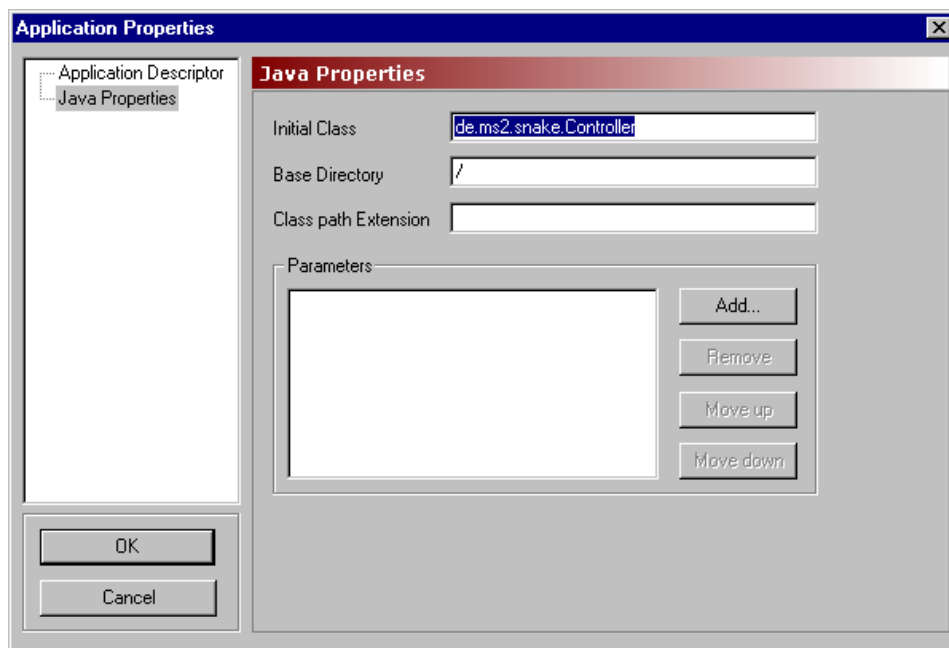

Application Descriptor Name	TS 101 812 identity
Initial Class:	DVB-J Application Location Descriptor
Base Directory:	DVB-J Application Location Descriptor
Class Path Extension:	DVB-J Application Location Descriptor
Parameters	DVB-J Application Descriptor

**HTML Properties screen.** All the properties on this page are described in the DVB-Java Specific descriptors of the MHP specification: TS 101 812 v1.1.1, Section 10, Application Signaling.

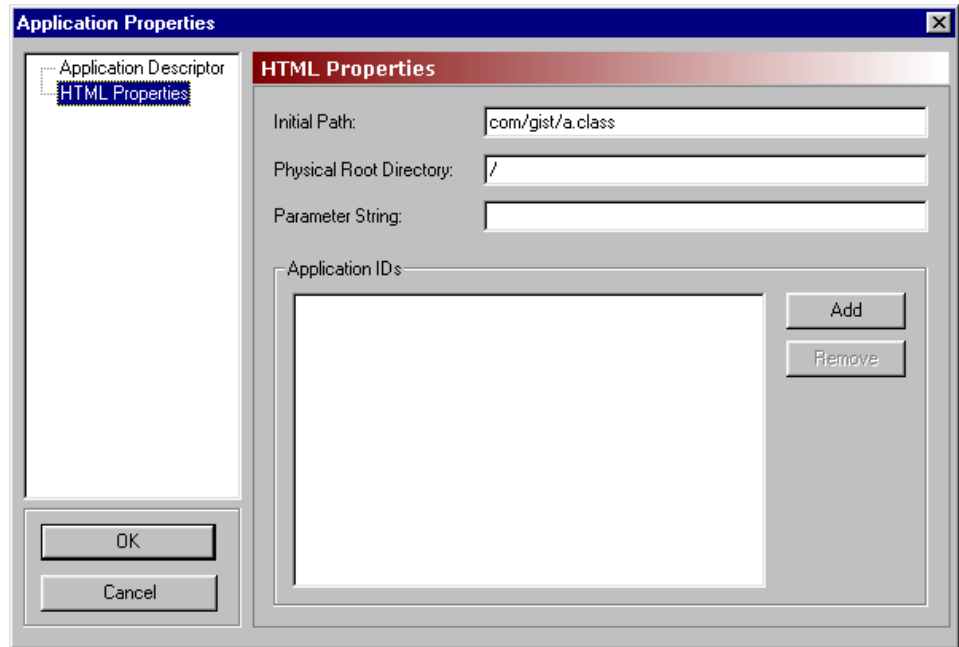

Application Descriptor Name	TS 101 812 identity
Initial Path:	DVB-HTML Application Location Descriptor
Physical Root Drive:	DVB-HTML Application Location Descriptor
Parameter String:	DVB-HTML Application Descriptor

## Synchronicity

Directory objects included in carousels are simply references to directories that exist elsewhere; for example, a PC hard drive.

If the **Include in Synchronization** checkbox is enabled for a directory, the directory will be included in the Synchronization process. When **Session > Synchronise...** is selected, the source directory structure is matched with the carousel directory structure. Any objects missing from either the source directory structure or the carousel directory structure are listed in the Synchronizing MHP Object Carousel dialog box (as shown in the following screenshot).

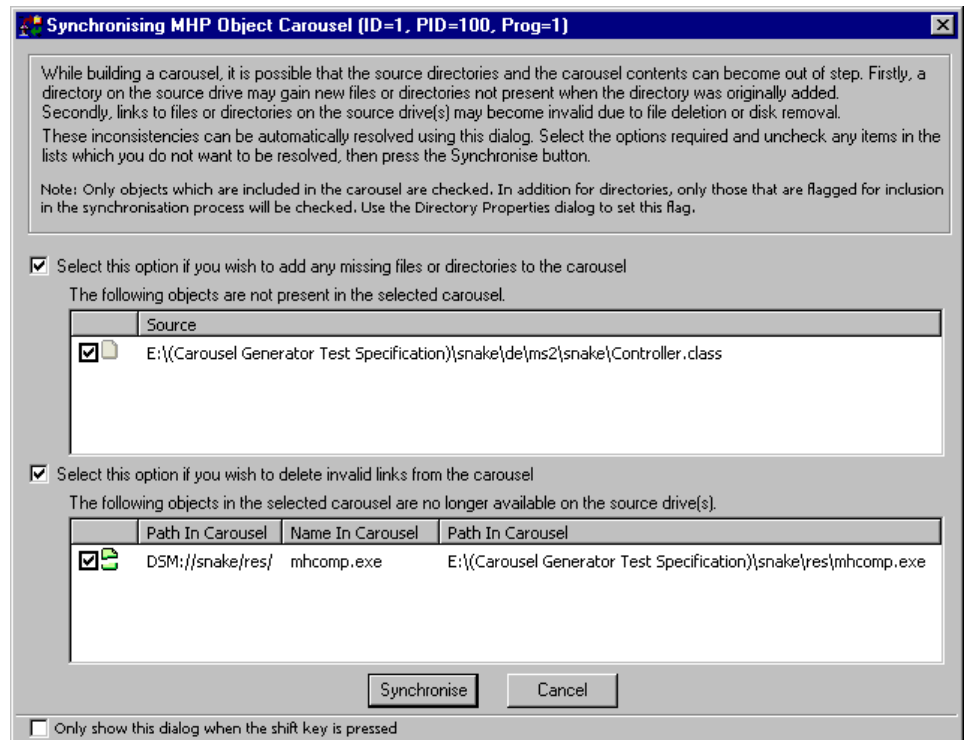

Files or directories available at source but not currently included in the carousel can be automatically added to the carousel by enabling the checkbox (**Select this option if you wish to add any missing files or directories to the carousel**). Individual files and directories listed in the panel can be included or excluded from the activity by enabling or disabling the adjacent checkbox.

Files or directories listed in the carousel but not available at the source can be automatically removed from the carousel by enabling the checkbox (**Select this option if you wish to delete invalid links from the carousel**). Individual files and directories listed in the panel can be included or excluded from the activity by enabling or disabling the adjacent checkbox.

Select **Synchronise** to synchronize the carousel with the source files in accordance with the checkbox selections.

**NOTE.** If the *Include in Synchronization* checkbox is disabled for a directory, this directory will not be compared to the source directory and neither will any subdirectories, regardless of their individual settings.

## Collections

(See *Carousel Generator Overview*, page 7–2)

Collections provide a means by which objects can be grouped and transmitted in a single carousel with differing properties, such as repetition rate and compression. Each collection can have different properties; all objects in a collection are transmitted with the same properties.

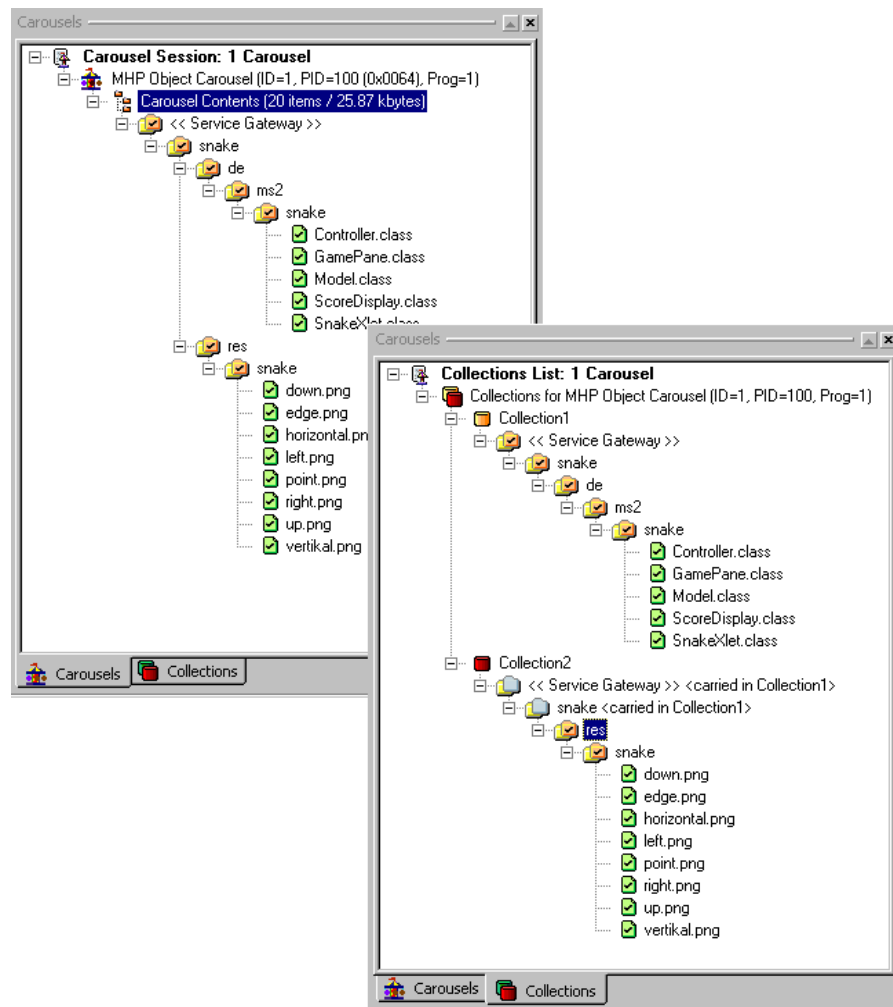

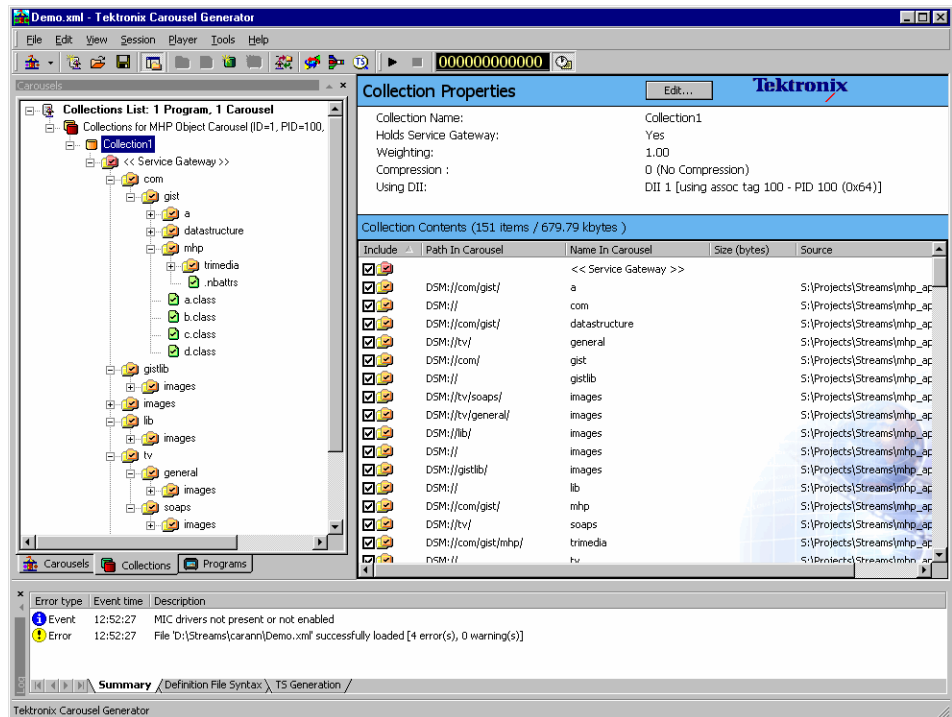

Collections can be viewed by selecting the **Collections** tab in the Session window.



A summary of a collection’s properties is displayed in the Properties window. With a collection node highlighted, the contents of the collection can be viewed.

Three icons are used at the Collection node:

-  (orange) Collection containing the Service Gateway.  
At least one collection must exist during any session.  
The collection containing the Service Gateway cannot be deleted
-  (red) Ordinary collection.
-  Compressed collection.

To open the Collection properties dialog box, select **Edit...** in the Collection Properties bar.

## Collection Properties

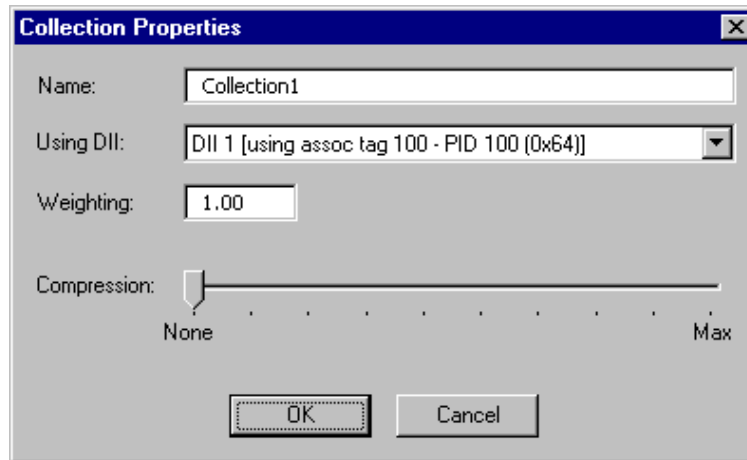

**Name:** Enter the required name.

**Using DII:** This is the list of all the DIIs in the carousel. The Collections in the carousel (and therefore the generated DSMCC modules) can be distributed among several DIIs or all be referenced by a single DII. This enables, for example, a minimal collection containing just the objects needed for booting to be referenced in a DII with a short cycle time.

**Weighting:** This is the relative priority of the collections in a single carousel. For example, the objects in a collection with a weighting of 1.5 will be repeated half as often as those in a collection with a weighting of three.

This enables, for example, boot classes in a collection to be given a higher weighting than the other files in a carousel. The weighting is a floating point value so virtually any ratio can be achieved.

Range: 0 to 10000

A value of 0 signifies the objects will not appear in the stream.

**Compression:**  The modules can be optionally compressed to decrease module size. There are 10 levels of compression ranging from 0 (no compression) to 9 (maximum compression). Compression is applied to the complete collection, although compression can be applied via any of the property dialog boxes. The collection node icon in the Collections view will indicate that compression is to be applied.

### Adding a New Collection

To add a new collection, right-click on the collections node in the Collections Session window and select **New Collection**. The properties of the new collection can be modified as required.

### Removing a Collection

To delete a collection, highlight the collection node and select **Edit > Delete Collection**. However, note that a collection cannot be deleted while it contains objects or while it contains the Service Gateway. These objects must be deleted or moved to another collection.

### Moving Objects between Collections



Objects can be dragged and dropped or cut and pasted between collections in the same carousel.

When dragging and dropping directories, pressing the Shift key down while the object is moved will move only the directory, not the contained items. If the Shift key is not used, the directory and its contents are moved.

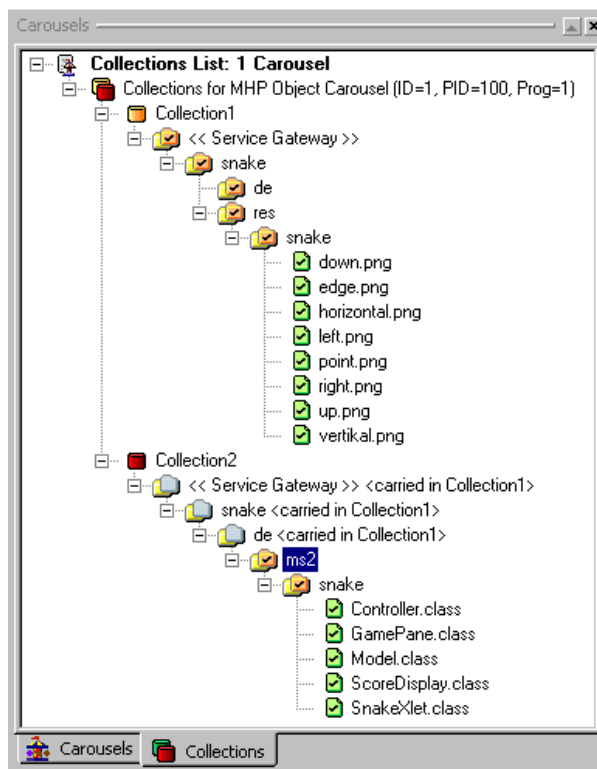
When items (file or directory) that are part of a tree structure are moved between collections, the complete path, from the Service Gateway is shown. The icons above the moved object are grayed out to indicate that they are carried in another collection (in the screenshot, they are the directory icons without a check mark or a cross within them).



The node description indicates the owning collection.

**NOTE.** When an object is not included in the synchronization process, the icon changes from  to  (see also Synchronicity, page 7–65).

Objects can also be moved between collections in the same carousel by right-clicking on the object to be moved and selecting the collection from the **Move to Collection** list. All current collections will be included in the list.

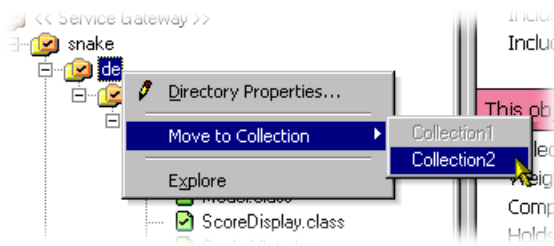

## Programs

(See *Carousel Generator Overview*, page 7–2)

Programs allow audio and video content to be added to the carousel-carrying stream. An example of the Program view is shown below:

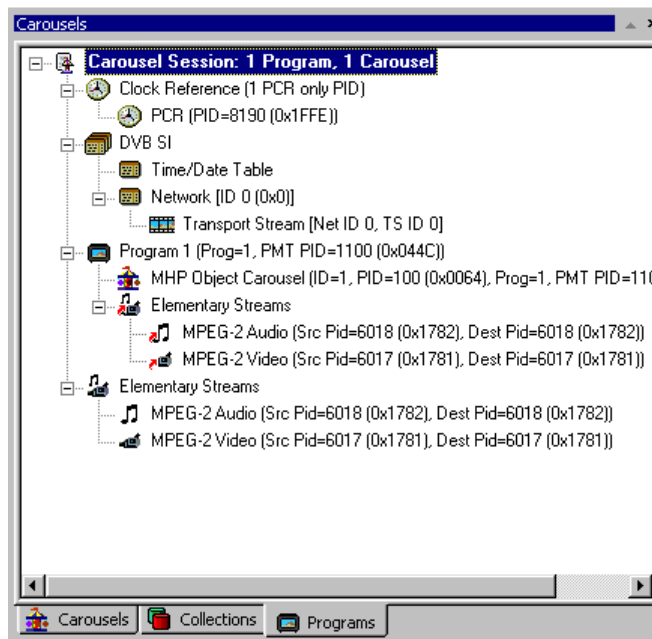



Note that the Carousel Session is still the 'root' of the view, but in this view, the program content is also shown; this includes tables and streams.

PCR PID references are displayed under the Clock Reference node.

Mandatory PSI/SI information is created by default and included in the generated stream. Changes made to the stream content are reflected in the PSI/SI information. Individual settings are accessible in the various Programs properties dialog boxes.

The **PSI/SI** node displays either MPEG or DVB service information that cannot be easily included elsewhere.

- For MPEG PSI, only the Transport Stream ID, which is carried in the PAT, is displayed.
- For DVB SI, the Transport Stream ID is augmented by mandatory DVB SI (NIT, SDT (actual), EIT (actual present/following) and TDT.) The TDT (**Time/Date Table**) and the NIT (**Network**) are the only entries under the PSI/SI node. Parameters for the other tables are available in other dialog boxes.

Under each **Program** node is a list of all the program components - Carousels and video and audio elementary streams.

The **Elementary Streams** node lists the elementary streams that are included in the stream. These can be associated with one or more programs. Note that the elementary streams will be included in the generated stream even if they are not associated with a program.

**Clock Reference** This node indicates which PIDs are carrying PCR.

**Adding a PCR.**

1. Highlight the Clock Reference node in the Programs view.
2. From the right-click menu select **New PCR...**

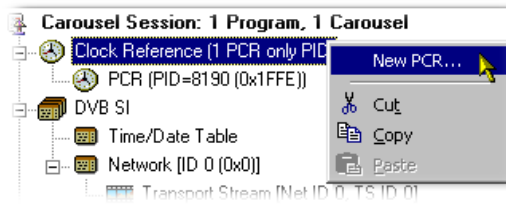

3. In the **PCR PID Properties** dialog box, make the changes required and select **OK**.

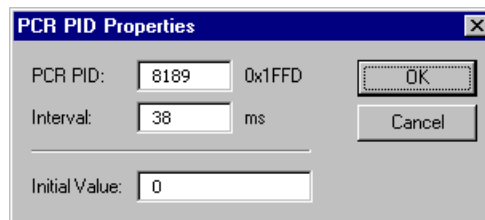

Note that the new PCR is added to the Clock Reference node.

Also available on the Clock Reference right-click menu are Cut, Copy, and Paste. These operations follow normal Windows conventions. Messages will be displayed where conflicts arise between existing PCRs and proposed new or pasted PCRs.

**PCR Edit.** The **PCR PID Properties** dialog box of an existing PCR PID can be opened by highlighting the PCR PID and selecting **Properties...** from the right-click menu.

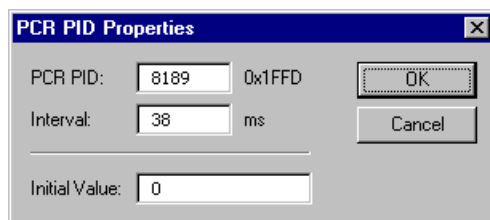
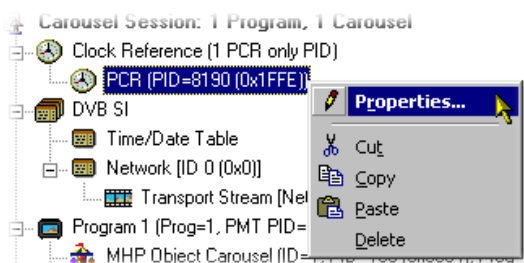

**PSI/SI** The content of the SI node will depend on the SI Type selected: MPEG or DVB.

**SI Type.** SI Type is normally set in the Stream Generation properties (see page 7–40). However, a change can be made at any time before generation of the stream.

Switching SI types may involve some loss of data or some creation of default values. When switching from MPEG PSI to DVB SI, default values are applied to the TDT and Network information; the Transport Stream ID will be copied. Switching from DVB SI to MPEG PSI requires only the Transport Stream ID to be copied. In this phase, any user changes to the default values in the DVB SI properties will be lost and will need to be reentered if the SI type is changed back to DVB, or a new session is created.

The EIT and SDT information is maintained between switching SI type as it is stored in the Program Properties. The tables will simply not be generated if the type is MPEG.

To switch between SI types during a session, highlight the **SI** node in the Programs view and select the required **SI Type** from the right-click menu.

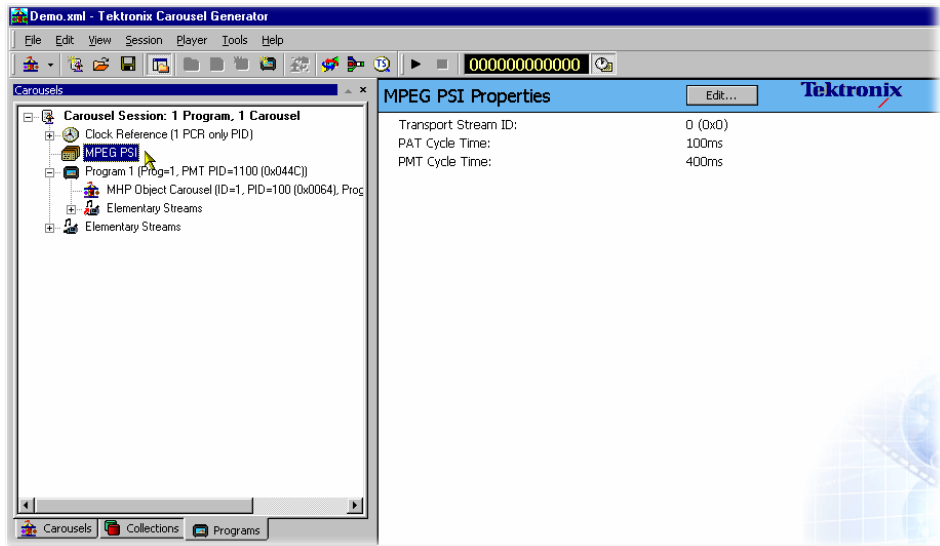

Figure 7-1: MPEG PSI

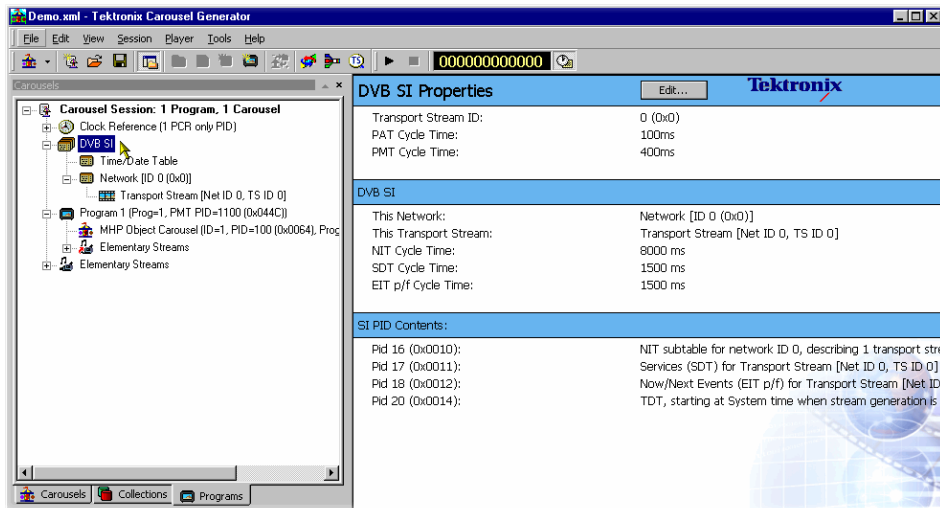
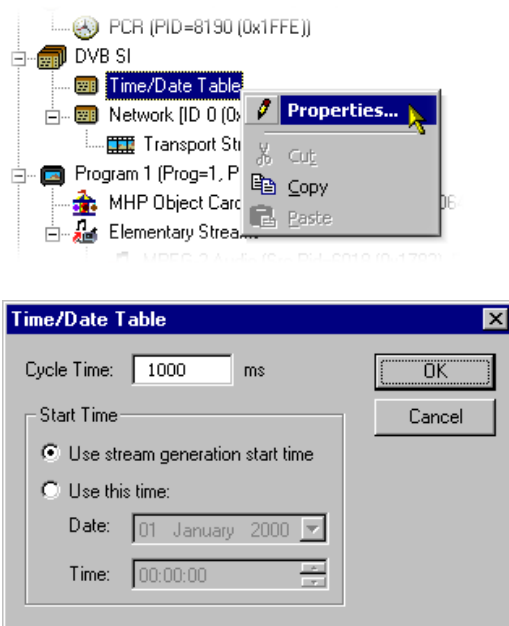

Figure 7-2: DVB SI

**Time/Date Table (DVB Only).** The Time/Date Table carries a UTC time in the stream, which is set to a starting value when the stream is generated. It is then continually updated throughout the stream to reflect the passing of time. The default setting of the initial value will be the time the generation is started, but this can be changed to any user defined value.

To edit the Time/Date Table parameters, highlight the **Time/Date Table** node and select **Properties...** from the right-click menu. The Time/Date Table Properties dialog box is displayed.



Cycle Time gives the frequency at which the time and date information should be repeated in the generated stream.

## Elementary Streams and Programs

Audio and video elementary can be imported and incorporated into the generated stream. Subsequently, the imported streams can be associated with one or more programs.

### Importing Elementary Streams.

1. In the Programs view, highlight the **Elementary Streams** node and select **Import Elementary Stream(s)...** from the right-click menu.

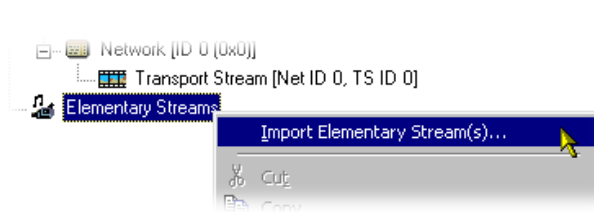

The **Add New Elementary Stream** dialog box is displayed:

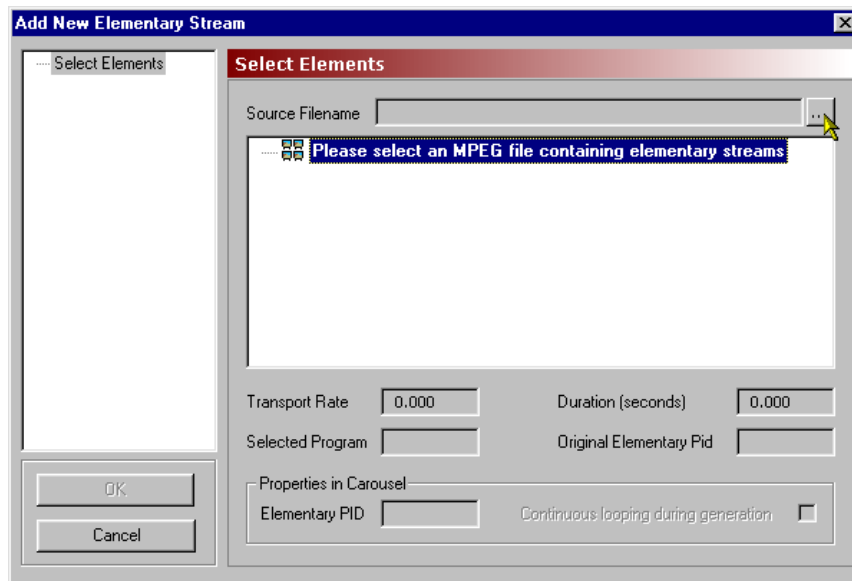

2. Use the browse button to select the source file (mpg) from which the elementary streams are to be imported:

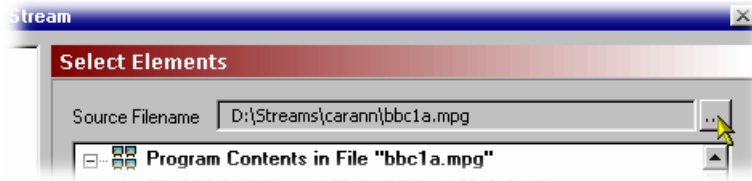

All programs in the source file are displayed, but only one program, or the elementary streams from one program, can be imported into a session.

3. Highlight the program or elementary stream(s) to be imported.

Select **OK** to import the program/stream(s).

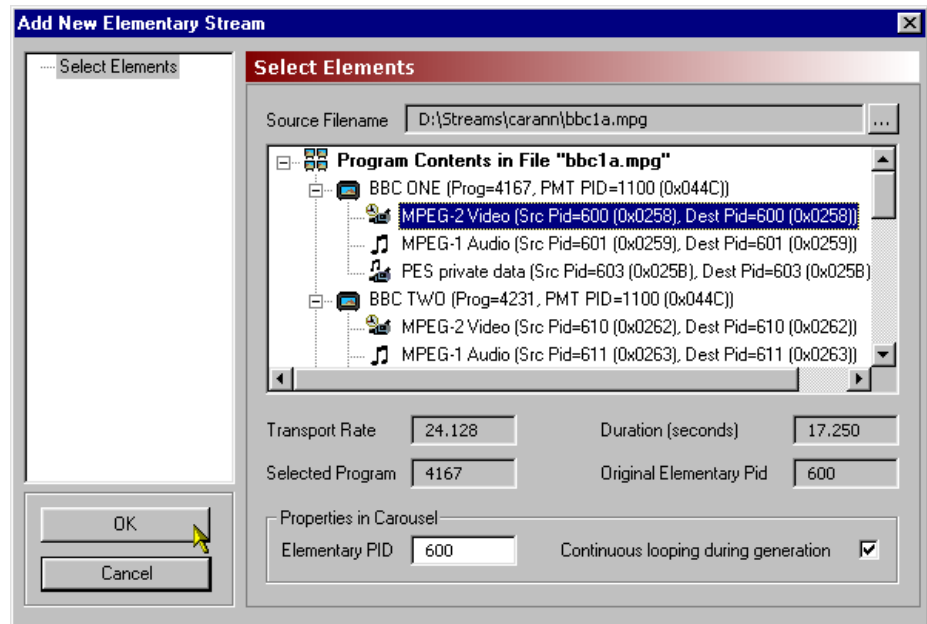

Note that selected elementary streams are displayed under the **Elementary Streams** node in the Programs view.

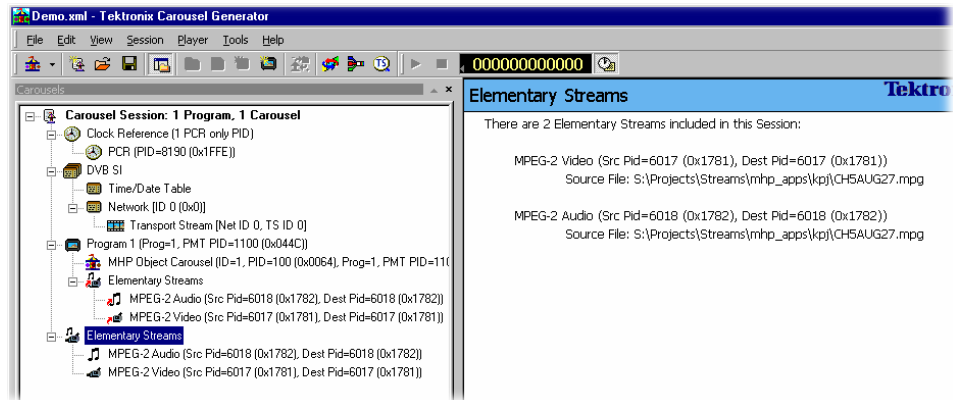

**Elementary Stream Properties.** Imported elementary streams are allocated to the same PID used in the source program. If there is any conflict with existing PIDs in the session, a warning is displayed and an opportunity offered to make changes.

The elementary stream properties dialog box allows the PID to be changed. A warning will be displayed if a conflict with an existing PID occurs. Continuous looping of the stream during generation can also be enabled.

To select the Elementary Stream Properties dialog box, highlight the elementary stream and select **Elementary Stream Properties** from the right-click menu.

**Linking Elementary Streams to Programs.** When a carousel is created, a Program node is automatically created. If the Carousel Wizard is used, elementary streams can be added during the process. Streams can also be added from a selected program as required.

Streams are added to the Program node(s) by dragging and dropping them from the Elementary Stream node. Note that in this case, they are simply linked to the Elementary Stream entry; if they are deleted from the program, they will continue to be listed under the Elementary Stream node. However, if an elementary stream is deleted from the Elementary Streams node, it will also be deleted from the programs in which it is used.

Note also that the Elementary Streams Properties dialog box (when accessed via the Program entry) allows descriptors to be added to the elementary stream information loop in the PMT.



## Output Stream Generation

To start generating the output stream, select **Player > Start Payout**. The parameters used are part of the Stream Generation properties (page 7–40).

Errors occurring during stream generation are reported in the **TS Generation** tab of the Log view.

## Carousel Definition File

The current state of the carousel generator session can be saved to disk at any time during the creation process using the **File > Save Carousel Session** or **File > Save Carousel Session As...** options. This can then be reloaded at any time using the **File > Open Carousel Session...** option. The format of the saved file is standard XML and can be viewed in any XML compatible viewer (for example, Internet Explorer 5 and up); editing the XML file is not recommended. Errors in the syntax of the XML file will be reported in the Definition File Syntax tab of the Log view; errors are summarized on the Summary tab of the Log view.



# PSI and SI in the Carousel Generator Output Stream

The Carousel Generator creates various PSI and SI tables while generating its output stream. The exact contents of the PSI and SI depends on many user settings; this section describes most of the auto-generated content and which options or properties affect that content. Note that all PSI/SI related properties can be accessed through nodes in the program tab.

## PSI/SI Mode Settings

There is one field that has a huge effect on the PSI and SI tables that Carousel Generator produces – the Session’s ‘PSI/SI type’ field. This can be accessed from the Stream Generation Properties dialog box (**Player > Stream Generation Properties**), or by right-clicking on the SI node in the program tab, selecting the **SI Type** sub-menu, and selecting one of the two options.

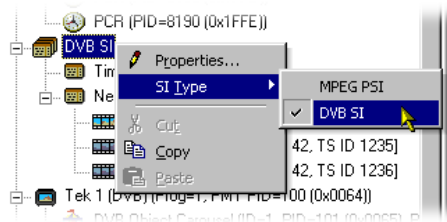

### MPEG PSI

PAT, PMT, and AIT (for MHP carousels) will be generated.

### DVB SI

In addition to the standard MPEG tables, Carousel Generator will output NIT actual, SDT actual, EIT present/following actual and TDT sections.

## MPEG PSI tables

**Table 7-11: Program Association Table (PAT)**

Table Syntax	CG Value	Comment
program_association_section() {		
table_id	0x00	
section_syntax_indicator	1	
'0'	0	
reserved	0x3	
section_length	auto	
transport_stream_id	user	SI node > Properties... > (MPEG SI page) 'Transport Stream ID' field.
reserved	0x3	
version_number	0	CG does not support table versioning.
current_next_indicator	1	
section_number	auto	depends on the number of programs.
last_section_number	auto	depends on the number of programs.
for (i=0; i<n; i++) {		
program_number	user	Program node > Properties... > (PMT entry page) 'Program Number' field.
reserved	0x7	
if (program_number == 0) {		CG does not specify the network PID.
network_PID	n/a	13818-1 describes it as 'optional'.
}		
else {		
program_map_PID	user	Program node > Properties... > (PMT entry page) 'PMT PID' field.
}		
}		
CRC_32	auto	
}		

(ISO/IEC 13818-1 (Systems) section 2.4.4.3)

**Table 7-12: Program Map Table (PMT)**

Table Syntax	CG Value	Comment
TS_program_map_section() {		
table_id	0x02	
section_syntax_indicator	1	
'0'	0	
reserved	0x3	
section_length	auto	
program_number	user	Program node > Properties... > (PMT entry page) 'Program Number' field.
reserved	0x3	
version_number	0	CG does not support table versioning.
current_next_indicator	1	
section_number	0	
last_section_number	0	
reserved	0x7	
PCR_PID	user	Program node > Properties... > (PMT entry page) 'PCR PID' dropdown menu.
reserved	0xF	
program_info_length	auto	
for (i=0; i<program_info_length; i++) {		
descriptor()	auto + user	Auto generation depends on carousel type. See 'carousel descriptors' note below.  User can add additional descriptors via Program node > Properties... > (Program Descriptors page)
}		
for (i=0; i<N1; i++) {		Carousel Generator will add elementary streams as required. Streams include carousel data, AITs, and imported PIDs.
stream_type	auto	Stream type 11 for carousel data, stream type 5 for AIT data, and the source stream type of any imported PIDs.
reserved	0x7	
elementary_PID	user	User editable – edit method depends on the type of stream.
reserved	0xF	
ES_info_length	auto	
for (i=0; i<N2; i++) {		
descriptor()	auto + user	Auto generation depends on stream type and carousel type.

**Table 7-12: Program Map Table (PMT) (Cont.)**

Table Syntax	CG Value	Comment
}		
}		
CRC_32	auto	
}		
(ISO/IEC 13818-1 section 2.4.4.8)		

**Carousel Descriptors in the PMT**

The various standards supported by the Carousel Generator have differing signaling requirements, so the type and content of descriptors added to the PMT depend on the carousel types contained in a program.

**DSM-CC Object Carousels (ISO/IEC 13818-6 defined).** The basic 13818-6 standard only supports a single carousel per program, and requires that a carousel\_identifier\_descriptor be inserted in the program\_info loop (first descriptor loop) of the PMT section for a program carrying a DSM-CC carousel.

**Table 7-13: DSM-CC object carousels - Carousel identifier descriptor**

Descriptor Syntax	CG Value	Comment
carousel_identifier_descriptor {		
descriptor_tag	0x13	
descriptor_length	auto	
carousel_identifier	user	Carousel node > Properties... > (General) Carousel ID
for (n=0; n<N; n++) {		
private_data_byte	n/a	These bytes are not used when signaling
}		a basic DSM-CC Object Carousel
}		
(ISO/IEC 13818-6 (Extensions for DSM-CC) section 11.4.1)		

DSM-CC Object Carousels are carried on one or more PIDs referenced by the PMT with stream type 11. The ES\_info loop for each of these streams contains an association\_tag\_descriptor which maps the association\_tag used by DSM-CC messages to a particular PID.

**Table 7-14: DSM-CC object carousels - Association tag descriptor**

Descriptor Syntax <sup>4</sup>	CG Value	Comment
association_tag_descriptor {		
descriptor_tag	0x14	
descriptor_length	auto	
association_tag	user	Carousel node > Properties... > (PID Settings) Association tag
use	auto	0 if the PID is used for a DSI, 1 otherwise
selector_byte_length	auto	
for (n=0; n<N1; n++) {		
selector_byte	auto	not used if 'use' is 1, otherwise follows the use_0_selector_bytes format
}		
for (n=0; n<N2; n++) {		
private_data_byte	n/a	not used
}		
}		
use_0_selector_bytes {		
transaction_id	auto	Matches the transaction id of the DSI
timeout	0xFFFFFFFF	timeout unknown
}		

(ISO/IEC 13818-6 section 11.4.2)

**DVB Object Carousels (ETSI EN 301 192 defined).** Although not mentioned in the DVB data standard (ETSI EN 301 192: Specification for the transmission of data services in DVB bitstreams), the DVB implementation guidelines for data broadcasting allow support for multiple Object Carousels per program, by allowing the carousel\_identifier\_descriptor to be transmitted in the second descriptor loop of the PMT.

“DVB Guideline: The carousel\_identifier\_descriptor() shall be inserted in the second descriptor loop of the PMT (ES\_info) corresponding to the elementary stream carrying the DSI of the object carousel. This allows more than one object carousel per MPEG-program and implicitly identifies the PID on which each carousel should be booted from.”  
(TR 101 202 (Implementation Guidelines for Data Broadcasting) section 4.7.7.1)

Carousel Generator therefore transmits a carousel\_identifier\_descriptor for every DVB Object Carousel in a program, as specified by this implementation guideline.

DVB also extends the carousel\_identifier\_descriptor slightly, by defining the contents of the private\_data\_byte section further with what it calls a FormatSpecifier. However, CarouselGenerator only uses the required parts of this extension - it sets the FormatId to zero, which indicates that no format specifier is provided.

**Table 7-15: DVB object carousels - Private\_data\_byte syntax**

Private_data_byte syntax	CG Value	Comment
carousel_identifier::private_data_bytes {		
FormatId	0	0 indicates no FormatSpecifier present
FormatSpecifier() {		
FormatSpecifier_byte	n/a	Not used by Carousel Generator
}		
for (n=0; n<N1; n++) {		
private_data_byte	n/a	Not used by Carousel Generator
}		
}		

TR 101 202 (Implementation Guidelines for Data Broadcasting) section 4.7.7.1

An association\_tag\_descriptor is added to the ES\_info loop in exactly the same way as for DSM-CC object carousels.

Two more descriptors are also added to the ES\_info loop for streams carrying DVB object carousels – the data\_broadcast\_id\_descriptor and the stream\_identifier\_descriptor. Both are defined in EN300 468 (Specification for Service Information in DVB systems).

**Table 7-16: DVB object carousels - Descriptors**

Descriptor Syntax	CG Value	Comment
stream_identifier_descriptor {		
descriptor_tag	0x52	
descriptor_length	1	
component_tag	user	LSB of the association_tag for this stream
}		
data_broadcast_id_descriptor {		
descriptor_tag	0x66	
descriptor_length	2	



**Table 7-16: DVB object carousels - Descriptors (Cont.)**

Descriptor Syntax	CG Value	Comment
data_broadcast_id	7	DVB Object Carousel code
for (i=0; i<N; i++) {		
id_selector_byte	n/a	DVB Object Carousels do not use these
}		selector bytes
}		

**DTT Object Carousels (DTG D-Book (DTT Requirements for Interoperability)).** Most of the PMT signaling for DTT Object Carousels is the same as for DVB Object Carousels. However, the D-Book does specify the contents of the id\_selector\_byte section of the data\_broadcast\_id\_descriptor, and also requires that the data\_broadcast\_id value in that descriptor is 262 (0x106).

**Table 7-17: DTT object carousels**

DTT id_selector_bytes Syntax	CG Value	Comment
for (i=0; i<descriptor_length-2; i++) {		
application_type_code	user	DTT Object Carousel node > Properties... > (DTT Applications page). Application codes list contains the app codes used.
boot_priority_hint	user	Boot priorities accessed as above.
app_specific_data_length (N2)	0	
for (j=0; j<N2; j++) {		
app_specific_data_byte	n/a	Not used.
}		
}		

(UK DTG D-Book (Digital Terrestrial Television Requirements for Interoperability) section 18.5.2.1)

**MHP Object Carousels (ETSI TS 101 812).** MHP uses an additional table, the AIT, for most of its signaling requirements. The location of the AIT table for a program is identified through an elementary stream PID entry in the PMT with stream type 5. The ES\_info loop for the AIT PID also carries an application\_signaling descriptor (AIT information is given in the DVB SI Tables section of this appendix):

**Table 7-18: MHP object carousels - Application signaling**

Descriptor Syntax	CG Value	Comment
application_signaling_descriptor {		
descriptor_tag	0x6F	
descriptor_length	auto	
for (i=0; i<descriptor_length; i++) {		
application_type	auto	An entry for application_type 1 will be present if any Java apps are defined in the carousel, and an entry for type 2 will be present if any HTML apps are defined in the carousel.
reserved_future_use	0x7	
AIT_version_number	0	CG does not support table versioning – all tables have version number 0.
}		
}		

(ETSI TS 101 812 (Multimedia Home Platform (MHP) specification) section 10.7.1)

The PMT signaling for MHP carousel carrying streams is very similar to that for DVB Object Carousels. The only difference is that, like DTT, MHP defines additional content for the data\_broadcast\_id\_descriptor's data\_broadcast\_id value and id\_selector bytes. The MHP data\_broadcast\_id value is 240 (0xF0), and the id\_selector bytes are as defined below:

**Table 7-19: MHP object carousels - ID selector**

MHP id_selector_bytes Syntax	CG Value	Comment
for (i=0; i<descriptor_length-2; i++) {		
application_type	auto	An entry for application_type 1 will be present if any Java apps are defined in the carousel, and an entry for type 2 will be present if any HTML apps are defined in the carousel.

(ETSI TS 101 812 section 10.7.2.2)

## DVB SI Tables

The following SI is only generated when the session's SI type is set to DVB SI. All user-editable properties of these tables can be accessed through nodes in the Programs tab.

### Network Information Table (NIT)

The Carousel Generator only generates NIT actual sections, and the contents of the NIT can be accessed by editing the properties of the Network node and its children.

**Table 7-20: Network information table**

Table Syntax	CG Value	Comment
<code>network_information_section() {</code>		
<code>table_id</code>	0x40	NIT actual – CG does not generate NIT other sections.
<code>section_syntax_indicator</code>	1	
<code>reserved_future_use</code>	1	
<code>reserved</code>	0x3	
<code>section_length</code>	auto	
<code>network_id</code>	user	Network node > Properties... > 'Network ID' field
<code>reserved</code>	0x3	
<code>version_number</code>	0	CG does not support table versioning
<code>current_next_indicator</code>	1	
<code>section_number</code>	auto	
<code>last_section_number</code>	auto	
<code>reserved_future_use</code>	0xF	
<code>network_descriptors_length</code>	auto	
<code>for (i=0;i&lt;N;i++) {</code>		A <code>network_name_descriptor</code> will always be added, with the name
<code>descriptor()</code>	auto + user	Specified in the Network Properties > 'Name' field.
<code>}</code>		The user can add custom descriptors to this loop by editing the descriptor list in the Network Properties dialog box.
<code>reserved_future_use</code>	0xF	
<code>transport_stream_loop_length</code>	auto	
<code>for (i=0; i&lt;N; i++) {</code>		CG will always add at least one transport stream to this loop (the 'actual' transport stream' but the user can add additional transport streams (by right-clicking on the network node).
<code>transport_stream_id</code>	user	Transport Stream node > Properties... > (Transport Stream page) Transport Stream ID field

**Table 7-20: Network information table (Cont.)**

Table Syntax	CG Value	Comment
original_network_id	user	As above > Original Network ID field
reserved_future_use	0xF	
transport_descriptors_length	auto	
for (j=0; j<N; j++) {		One of the three delivery system descriptors will always be present (see 'Delivery System Descriptors' below)
descriptor()	auto + user	The user can also add custom descriptors via Transport Stream node > Properties... > (Transport Stream page) Descriptors list
}		
}		
CRC_32	auto	
}		

(ETSI EN 300 468 (Specification for Service Information in DVB systems) section 5.2.1)

### Delivery System Descriptors

Every transport stream listed in the NIT will contain at least one descriptor – one of either the cable delivery system descriptor (ETSI EN 300 468 section 6.2.12.1), the satellite delivery system descriptor (ETSI EN 300 468 section 6.2.12.2) or the terrestrial delivery system descriptor (ETSI EN 300 468 section 6.2.12.3). The type of descriptor used, and the contents of all its fields, are edited through the Transport Stream node > **Properties...** > **Delivery System** page.

All of the delivery system descriptor fields defined in EN 300 468 can be modified.

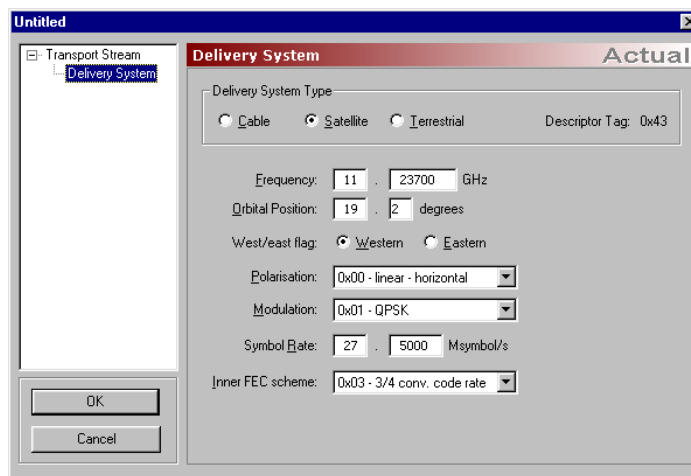

## Service Description Table (SDT)

**Table 7-21: Service Description Table (SDT)**

Table Syntax	CG Value	Comment
service_description_section() {		
table_id	0x42	SDT actual – CG does not generate SDT other sections.
section_syntax_indicator	1	
reserved_future_use	1	
reserved	0x3	
section_length	auto	
transport_stream_id	user	Matches the transport_stream_id of the actual transport stream
reserved	0x3	
version_number	0	CG does not support table versioning
current_next_indicator	1	
section_number	auto	
last_section_number	auto	
original_network_id	user	Matches the original_network_id of the actual transport stream
reserved_future_use	0xFF	
for (i=0; i<N; i++) {		CG auto-generates an entry for every program in the session.
service_id	auto	Matches the program number
reserved_future_use	0x3F	
EIT_schedule_flag	0	EIT schedule tables not supported.
EIT_present_following_flag	user	Transmission of an EIT_pf is user-controllable per service. See the EIT section below.
running_status	0x4	Always set to 4 – Running
free_ca_mode	0	Always set to 0 – No scrambling
descriptors_loop_length	auto	
for (j=0; j<N; j++) {		
descriptor()	auto	A service_descriptor is always added, and depending on the carousel content of the program, data_broadcast_descriptor(s) may be added.
}		
}		
CRC_32	auto	
}		

(ETSI EN 300 468 section 5.2.3)

## Service\_descriptor

**Table 7-22: Service descriptor**

Descriptor Syntax	CG Value	Comment
service_descriptor() {		All of the properties in this descriptor are accessed via the Program node that is associated with the service. Program node > Properties... > Additional SI page
descriptor_tag	0x48	
descriptor_length	auto	
service_type	user	> Service Type dropdown
service_provider_name_length	auto	
for (i=0; i<N; i++) {		
char	user	> Service Provider field
}		
service_name_length	auto	
for (i=0; i<N; i++) {		
char	user	> Service Name field
}		
}		

(ETSI EN 300 468 section 6.2.30)

### **Data\_broadcast\_descriptor**

The data\_broadcast\_descriptor is a DVB defined descriptor that can be used in either the SDT or EIT to indicate that a carousel is associated with a service or event. Carousel Generator only supports associating a carousel with a service, so will only add the data\_broadcast\_descriptor to the SDT.

**Table 7-23: Data broadcast descriptor**

Descriptor Syntax	CG Value	Comment
data_broadcast_descriptor() {		
descriptor_tag	0x64	
descriptor_length	auto	
data_broadcast_id	auto	depends on the type of carousel
component_tag	user	LSB of the assoc_tag of the PID carrying the carousel's DSI
selector_length	auto	
for (i=0; i<selector_length; i++) {		
selector_byte	auto	depends on the type of carousel

**Table 7-23: Data broadcast descriptor (Cont.)**

Descriptor Syntax	CG Value	Comment
}		
ISO_639-2[3]_language_code	"und"	CG does not use the text field, so the language code is set to "undefined"
text_length	0	
for (i=0; i<text_length; i++) {		
text_char	n/a	Not used
}		
}		
(ETSI EN 300 468 section 6.2.10)		

The use of the data\_broadcast\_descriptor, and the contents of the data\_broadcast\_id and selector\_bytes fields depend on the type of carousel(s) in the program.

**DSM-CC Object Carousel.** The DSM-CC standard does not define the data\_broadcast\_descriptor, and so a data\_broadcast\_descriptor is not added to the service entry for a program containing a DSM-CC object carousel.

**MHP Object Carousels.** MHP uses the AIT for all its signaling requirements, and so does not require the use of the data\_broadcast\_descriptor.

**DVB Object Carousels.** A data\_broadcast\_descriptor is added for every DVB Object Carousel contained in a program. The data\_broadcast\_id is set to 7, and the selector\_byte format is as follows:

**Table 7-24: DVB object carousel**

DVB selector_bytes Syntax	CG Value	Comment
Carousel_type_id	0x2	
Reserved	0x3F	
Transaction_id	auto	Matches the carousel DSI transaction ID
time_out_value_DSI	0xFFFFFFFF	not used
time_out_value_DII	0xFFFFFFFF	not used
Reserved	0x3	
leak_rate	0	
for (i=0; i<N; i++) {		

**Table 7-24: DVB object carousel (Cont.)**

DVB selector_bytes Syntax	CG Value	Comment
ISO_639_language_code	n/a	The object names loop is not used by the Carousel Generator.
object_name_length	n/a	
for (j=0; j<object_name_length; j++) {		
object_name_char	n/a	
}		
}		

(ETSI EN 300 468 section 6.2.10)

**DTT Object Carousels.** The DTG D-Book requires that there only be a single data\_broadcast\_descriptor per service, to identify the application type carried in that service. The Carousel Generator uses the first Carousel it encounters in a program that has at least one application id set as the carousel referenced by the data\_broadcast\_descriptor. Generally, only one of the DTT Object Carousels in a program should have any application IDs set.

Because only a single data\_broadcast\_descriptor is allowed per service, the component\_tag value of the descriptor is set to zero – the descriptor does not identify any particular stream as carrying a carousel.

The data\_broadcast\_id for the descriptor is set to 262 (0x106), and the selector\_bytes format is as follows:

**Table 7-25: DTT object carousel**

DTT selector_bytes Syntax	CG Value	Comment
for (i=0; i<selector_byte_length;i++) {		
application_type_code	user	The first application id defined in a DTT carousel contained in the service.
number_languages	0	
for (j=0; j<number_languages;j++) {		
ISO_639_language_code	n/a	Not used
}		
application_specific_data_length	0	
for (j=0; j<a_s_d_length; j++) {		
application_specific_data_byte	n/a	Not used
}		



**Table 7-25: DTT object carousel (Cont.)**

DTT selector_bytes Syntax	CG Value	Comment
}		
(UK DTG D-Book section)		

**Event Information Table (EIT)**

The Carousel Generator only supports the creation of EIT present following information, for the actual transport stream. The presence of EIT p/f sections for a particular service is user controllable, but where transmitted, information will only be included for the present (now) event. The following (next) event section will always be empty. If an EIT p/f is present for a particular service, the relevant EIT\_present\_following\_flag in the SDT will be set.

**Table 7-26: Event Information Table (EIT)**

Table Syntax	CG Value	Comment
service_description_section() {		
table_id	0x4E	EIT actual present/following – CG does not generate any other form of EIT.
section_syntax_indicator	1	
reserved_future_use	1	
reserved	0x3	
section_length	auto	
service_id	auto	
reserved	0x3	
version_number	0	CG does not support table versioning
current_next_indicator	1	
section_number	auto	section 0 is present event, 1 is following event
last_section_number	1	
transport_stream_id	user	Matches the transport_stream_id of the actual transport stream
original_network_id	user	Matches the original_network_id of the actual transport stream
segment_last_section_number	1	p/f table is not segmented
last_table_id	0x4E	Only table id 0x4E is used
for (i=0; i<N; i++) {		The present event section (section 0) will always contain a single event, while the following event section (section 1) will not contain any events. The following fields are therefore only used in section 0 of the EIT.
event_id	0	Event ID is always set to zero

**Table 7-26: Event Information Table (EIT) (Cont.)**

Table Syntax	CG Value	Comment
start_time	user	The start time will match the start time of the TDT.
duration	99:59:59	
running_status	0x4	Always set to 4 – Running
free_CA_mode	0	Always set to 0 – No scrambling
descriptors_loop_length	auto	CG always adds a single descriptor
for (i=0; i<N; i++) {		to the event descriptors loop, the
descriptor()	auto	short_event_descriptor.
}		
}		
CRC_32	auto	
}		

(ETSI EN 300 468 section 5.2.4)

**Short\_event\_descriptor**      The fields of the short\_event\_descriptor for the present event are all accessed through Program Node > **Properties...** > **Additional SI** page. This page also contains the checkbox (**Include EIT present/following section for this service**) that controls whether an EIT will be transmitted for a particular service.

**Table 7-27: Short event descriptor**

Descriptor Syntax	CG Value	Comment
short_event_descriptor() {		
descriptor_tag	0x4D	
descriptor_length	auto	
ISO_639-2[3]_language_code	user	> Language Code dropdown
event_name_length	auto	
for (i=0; i<event_name_length;i++) {		
event_name_char	user	Set to match the service name field
}		
text_length	auto	
for (i=0; i<text_length; i++) {		
text_char	user	> Description field
}		
}		

(ETSI EN 300 468 section 6.2.33)

**Time and Date Table (TDT)** The TDT is accessed through the Time/Date Table node under the DVB SI node in the program tab. It carries current time information, and the user can specify whether that information will be filled with the current system time, or start at a time specified by the user and increment in real time.

**Table 7-28: Time and date table**

Table Syntax	CG Value	Comment
time_date_section() {		
table_id	0x70	
section_syntax_indicator	0	
reserved_future_use	1	
reserved	0x3	
section_length	5	
UTC_time	auto/user	This value starts at the time specified by the user (Time/Date Table node > Properties... > Start Time) and increments appropriately during stream output.
}		
(ETSI EN 300 468 section 5.2.4)		

**Application Information Table (AIT)** The AIT (ETSI TS 101 812 section 10.4) is the main signaling component of the MHP standard, and the Carousel Generator will generate an AIT for every program that carries one or more MHP carousels containing applications. Note that if the MHP carousel(s) in a program do not have any applications defined an AIT will not be generated for that program.

The AIT is split into subtables based on the application\_type value. The current MHP spec defines two application types, Java and HTML, and Carousel Generator supports both. If only Java applications are present in the carousels in a program, only the Java subtable will be generated, and the same is true for HTML applications. If both application types are present in the carousel(s) in a program, both subtables of the AIT will exist for that program.

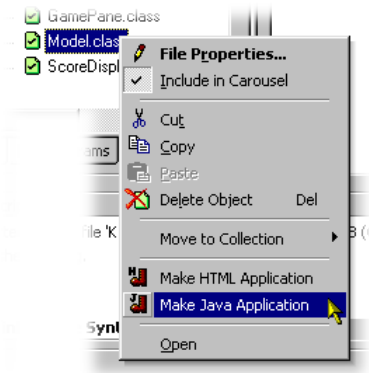

**Table 7-29: Application information table**

Table Syntax	CG Value	Comment
application_information_section() {		
table_id	0x74	
section_syntax_indicator	1	
reserved_future_use	1	
reserved	0x3	
section_length	auto	
application_type	auto	
reserved	0x3	
version_number	0	CG does not support table versioning
current_next_indicator	1	
section_number	auto	
last_section_number	auto	
reserved_future_use	0xF	
common_descriptors_length	0	
for (i=0; i<c_d_length; i++) {		
descriptor()	n/a	
}		
DVB_reserved_future_use	0xF	
application_loop_length	auto	
for (i=0; i<app_loop_length; i++) {		Carousel Generator will add applications as defined in the carousel. To create an application, right-click on the file and select Make HTML Application or Make Java Application.
application_identifier() {		
organisation_id	user	File node > Properties... > (Application Descriptor page) Organisation ID field

**Table 7-29: Application information table (Cont.)**

Table Syntax	CG Value	Comment
application_id	user	File node > Properties... > (Application Descriptor page) Application ID field
}		
application_control_code	user	File node > Properties... > (Application Descriptor page) Control Code dropdown
app_descriptors_loop_length	auto	
for (j=0; j<a_d_l_length; j++) {		
descriptor()	auto/user	Carousel Generator creates the appropriate descriptors for each application type automatically. However, fields in the properties pages allow the contents of these descriptors to be edited. See 'application descriptors' note below.
}		
}		
CRC_32	auto	
}		

**Application Descriptors in the AIT**

Every application listed in the AIT will have five descriptors in the app\_descriptors\_loop, but two of these depend upon the type of application (Java or HTML). The three common descriptors are the application\_descriptor, application\_name\_descriptor and transport\_protocol\_descriptor, and the two app specific descriptors will either be dvb\_j\_application\_descriptor and dvb\_j\_application\_location\_descriptor (for Java apps) or dvb\_html\_application\_descriptor and dvb\_html\_application\_location\_descriptor (for HTML apps).

**Common Application Descriptors.**

**Table 7-30: Application descriptor**

Descriptor Syntax	CG Value	Comment
application_descriptor {		Note. All of the user editable fields are accessed through File > Properties... > Application Descriptor page
descriptor_tag	0x00	
descriptor_length	auto	
application_profiles_length		
for (i=0; i<N; i++) {		> Application profiles list
application_profile	user	
version.major	user	

**Table 7-30: Application descriptor (Cont.)**

Descriptor Syntax	CG Value	Comment
version.minor	user	
version.micro	user	
}		
service_bound_flag	user	> Service Bound checkbox
visibility	user	> Visibility dropdown
reserved_future_use	0x1F	
application_priority	user	> Priority
for (i=0; i<N; i++) {		
transport_protocol_label	auto	Matches the transport_protocol_label value in the transport_protocol_descriptor.
}		
}		

(ETSI TS 101 812 section 10.7.3)

**Table 7-31: Application name descriptor**

Descriptor Syntax	CG Value	Comment
application_name_descriptor {		Accessed through the same page as described.
descriptor_tag	0x01	
descriptor_length	auto	
for (i=0; i<descriptor_length; i++) {		
ISO_639_language_code	user	> Language Code dropdown
app_name_length	auto	
for (i=0; i<a_n_length;i++){		
app_name_char	user	> Application Name field
}		
}		
}		

(ETSI TS 101 812 section 10.7.4)

**Table 7-32: Transport protocol descriptor**

Descriptor Syntax	CG Value	Comment
transport_protocol_descriptor {		
descriptor_tag	0x02	
descriptor_length	auto	
protocol_id	0x0001	Transport via OC
transport_protocol_label	auto	Set to match the component tag value
remote_connection	0	CG does not support remote carousels
component_tag	auto	Matches the component tag in the stream_identifier_descriptor for the DSI of the MHP Object Carousel that contains this application.
}		
(ETSI TS 101 812 section 10.8.1)		

**Java Application Descriptors.**

**Table 7-33: Java application descriptor**

Descriptor Syntax	CG Value	Comment
dvb_j_application_descriptor {		This descriptor specifies the Java application parameters, and is accessed on the Java app file > Properties... > Java Properties page.  The parameter list is edited by using the Parameters list box and buttons.
descriptor_tag	0x03	
descriptor_length	auto	
for (i=0; i<N; i++) {		
parameter_length	auto	
for (j=0; j<parameter_length; j++) {		
parameter_byte	user	
}		
}		
}		
(ETSI TS 101 812 section 10.9.1)		

**Table 7-34: Java application location descriptor**

Descriptor Syntax	CG Value	Comment
dvb_j_application_location_descriptor {		This descriptor specifies the Java application path, and is accessed via Java app file > Properties... > Java Properties page.
descriptor_tag	0x04	
descriptor_length	auto	
base_directory_length	auto	
for (i=0; i<base_directory_length; i++) {		
base_directory_byte	user	> Base Directory field
}		
classpath_extension_length	auto	
for (i=0; i<classpath_ext_length; i++) {		
classpath_extension_byte	user	> Classpath extension field
}		
for (i=0; i<N; i++) {		
initial_class_byte	user	> Initial class field
}		
(ETSI TS 101 812 section 10.9.2)		

### HTML Application Descriptors.

**Table 7-35: HTML application descriptor**

Descriptor Syntax	CG Value	Comment
dvb_html_application_descriptor {		This descriptor specifies the HTML application parameters, and is accessed via HTML app file > Properties... > HTML Properties page.
Descriptor_tag	0x03	
descriptor_length	auto	
appid_set_length	auto	
for (i=0; i<appid_set_length; i++) {		
application_id	user	> Application IDs list box
}		
for (j=0; j<N; j++) {		
parameter_bytes	auto	> Parameter String edit box
}		



**Table 7-35: HTML application descriptor (Cont.)**

Descriptor Syntax	CG Value	Comment
}		
(ETSI TS 101 812 section 10.10.1)		

**NOTE.** The *dvb\_html\_application\_descriptor* format shown above is that defined in TS 101 812 v1.1.2 (MHP v1.0.1) – previous versions of the standard did not have the *application\_id* loop. Carousel Generator can be made to revert to the older version of the descriptor (v1.0.0) for a particular carousel by checking the *MHP Object Carousel node > Properties... > (MHP page) Use old style (MHP v1.0.0) HTML application descriptor* checkbox.

**Table 7-36: HTML application location descriptor**

Descriptor Syntax	CG Value	Comment
<i>dvb_html_application_location_descriptor</i> {		This descriptor specifies the HTML application path, and is accessed on the HTML app file > Properties... > HTML Properties page.
<i>descriptor_tag</i>	0x04	
<i>descriptor_length</i>	auto	
<i>physical_root_length</i>	auto	
for (i=0; i< <i>physical_root_length</i> ; i++) {		
<i>physical_root_bytes</i>	user	> Physical Root Directory field
}		
for (i=0; i<N; i++) {		
<i>initial_path_bytes</i>	user	> Initial Path field
}		
(ETSI TS 101 812 section 10.10.2)		

## Summary

Carousel Generator v2.0 is designed to generate enough SI to create a fully DVB conformant stream, which should be enough to drive most set-top boxes. If any additional SI is required, another suitable tool (the Tektronix Multiplexer) should be used to insert the extra information into the generated stream.





# Multiplexer



# Table of Contents

<b>Multiplexer - Getting Started</b> .....	<b>8-1</b>
H.264 ES Input Characteristics .....	8-3
Starting the Program .....	8-4
Scripts .....	8-6
Opening a Stream .....	8-11
Closing Files .....	8-16
<b>Menus and Controls</b> .....	<b>8-17</b>
Menu Options .....	8-17
Toolbar .....	8-21
Status Bar .....	8-22
User Interface .....	8-23
<b>Wizards</b> .....	<b>8-29</b>
Transport Wizard .....	8-29
Program Wizard .....	8-35
<b>Views</b> .....	<b>8-49</b>
Navigator Views .....	8-50
Section View .....	8-53
Structure Diagram Manipulation .....	8-62
Event Log .....	8-63
Examine Transport Stream Window .....	8-64
SI Filtering .....	8-67
Component Views .....	8-71
Common Menu Options .....	8-80
<b>Editing in the Navigator Views</b> .....	<b>8-81</b>
Dragging and Dropping .....	8-81
Transport Stream .....	8-82
Programs .....	8-83
Tables .....	8-85
Sections .....	8-89
ES PIDs .....	8-98
DSM-CC .....	8-108
<b>Editing in Section View</b> .....	<b>8-111</b>
Editing Fields .....	8-112
<b>Multiplexing Transport Streams</b> .....	<b>8-119</b>
Starting the Multiplex Engine .....	8-119
Errors and Reporting .....	8-120
Stopping the Multiplex Engine .....	8-121
Exporting the Multiplex Configuration File .....	8-122
<b>Make Seamless</b> .....	<b>8-125</b>
Enabling the Seamless option .....	8-125
Seamless Settings .....	8-126
<b>Reference</b> .....	<b>8-127</b>
Abbreviations .....	8-127

## List of Tables

<b>Table 8-1: PTS/DTS Timestamp Updates</b> .....	<b>8-3</b>
<b>Table 8-2: File menu options</b> .....	<b>8-5</b>
<b>Table 8-3: View menu options</b> .....	<b>8-6</b>
<b>Table 8-4: Script Management</b> .....	<b>8-10</b>
<b>Table 8-5: File menu options</b> .....	<b>8-17</b>
<b>Table 8-6: Edit menu options</b> .....	<b>8-18</b>
<b>Table 8-7: View menu options</b> .....	<b>8-18</b>
<b>Table 8-8: Options menu options</b> .....	<b>8-19</b>
<b>Table 8-9: Multiplex menu options</b> .....	<b>8-20</b>
<b>Table 8-10: Window menu options</b> .....	<b>8-20</b>
<b>Table 8-11: Help menu options</b> .....	<b>8-21</b>
<b>Table 8-12: Icons</b> .....	<b>8-24</b>
<b>Table 8-13: Examine TS - File menu options</b> .....	<b>8-65</b>
<b>Table 8-14: Examine TS - Edit menu options</b> .....	<b>8-65</b>

# Multiplexer - Getting Started

The Tektronix Multiplexer provides off-line multiplexing of ATSC, MPEG-2, DVB, and ISDB transport streams.

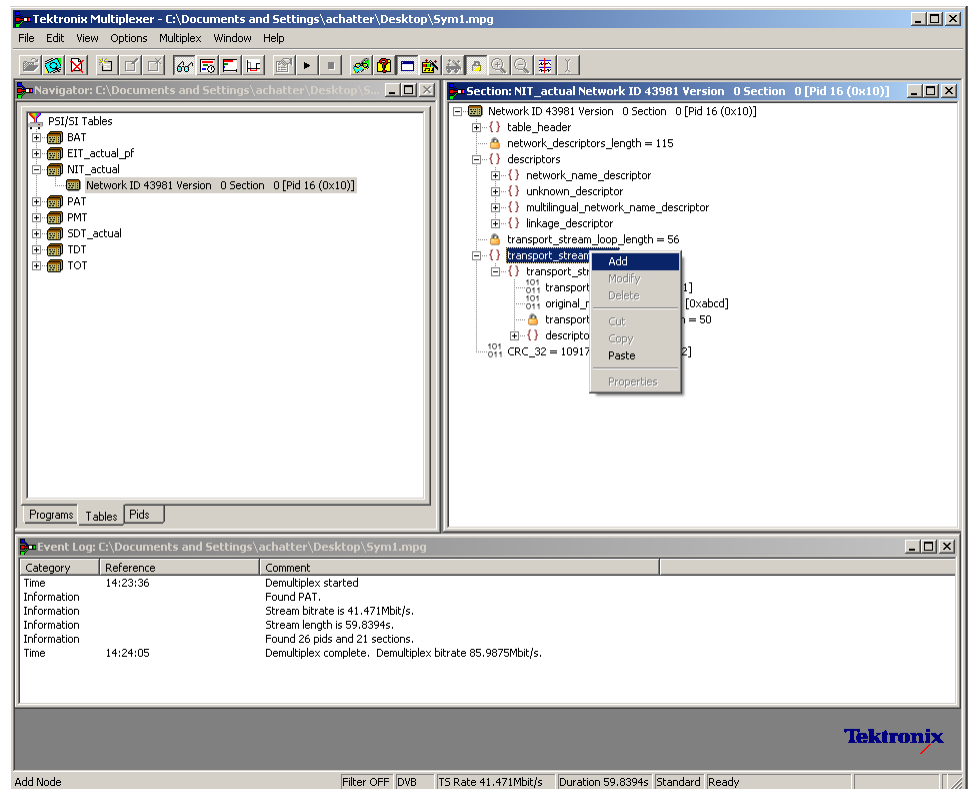

Transport streams (TS), elementary streams (ES), packetized elementary streams (PES), Packet Identifiers (PID) - can all be selected, manipulated and recombined to form customized, synthesized transport streams. Program Specific Information (PSI), Service Information (SI), and Program and System Information Protocol (PSIP) are often referred to as simply SI in this section.

The functionality provided includes:

- Wizards that facilitate the completion of common tasks, such as populating streams with Program Specific Information/ Service Information/ Program and System Information Protocol (PSI/SI/PSIP) and programs.
- Table contents are displayed in and edited from structure diagrams (tree diagrams).

- Transport Streams that either conform strictly to the standards selected for interpretation or have precisely engineered, known, nonconformances.
- Two or more instances of Multiplexer can run concurrently. This allows table information to be copied from one file to another.
- The source data for nonconformant streams can be saved in a raw format, which can be quickly reloaded as the basis for generating more stream data.
- Conformance of edits to the standards is checked interactively and enforced by default. Checking and enforcement may be turned off when specifying nonconformances to be introduced into the new transport stream.

On opening, streams are analyzed and displayed according to the selected standard: MPEG, DVB, ATSC, or ISDB. Scripts are used by the analysis process; this allows private PSI/SI tables and descriptors to be defined.

---

**NOTE.** *Most examples given in this section of the User Manual are based on DVB SI. You should remember that Multiplexer is equally at home with all major DTV standards, MPEG-2, DVB, ATSC, and ISDB as well as the major extensions to those standards.*

*The Transport Stream Analyzer program should always be used for reliable analysis of transport streams containing DSM-CC or MPE addressable sections.*

*In the absence of TS Analyzer, it is acceptable to use Multiplexer for analysis, provided that the DSM-CC or MPE scripts are first applied using Expert mode in the Stream Interpretation dialog box (see Scripts, page 8-6).*

*However, when multiplexing streams containing DSM-CC or MPE addressable sections, the related scripts must not be active.*

---



## H.264 ES Input Characteristics

The H.264 elementary streams used by the Multiplexer should comply with ISO/IEC-14496-10/2005 Rec. H.264. The transport stream generated by the Multiplexer should comply with ISO/IEC-13818-1/2000/AMD\_3/2004.

- SEI (Supplemental enhancement information) stream support

The multiplexer detects a H.264 stream as an SEI stream if the following conditions are met:

- VUI (video usability information) packet contains the coded bit rate.
- HRD (hypothetical reference decoder) parameters are specified in the SEI packets.

- Non-SEI stream support

Those streams that are not detected as SEI streams are assumed to be non-SEI streams.

### PTS/DTS Timestamp Generation

Table 8–1 lists the stream properties of H.264/AVC and generated transport stream characteristics.

**Table 8–1: PTS/DTS Timestamp Updates**

H.264/AVC stream properties			Comments	Generated TS characteristics	
SEI	VUI	BM(Valid Buffering Messages)		Bit rate	Comments
-	-	-	Stream without any buffering messages	Prompted or auto detected	TS will have PTS and DTS calculated at a constant frame rate from the VUI parameters of the stream unless you change the parameters. If the stream does not have VUI parameters 25 fps is taken as the default.
●	-	-	SEI NAL units potentially carrying private data	Prompted or auto detected	TS will have PTS and DTS calculated at a constant frame rate from the VUI parameters of the stream unless you change the parameters. If the stream does not have VUI parameters 25 fps is taken as the default.

**Table 8-1: PTS/DTS Timestamp Updates (Cont.)**

H.264/AVC stream properties			Comments	Generated TS characteristics	
●	●	-	SEI stream without full HRD data	Prompted or auto detected	TS will have PTS and DTS calculated at a constant frame rate from the VUI parameters of the stream unless you change the parameters. If the stream does not have VUI parameters 25 fps is taken as the default.
●	●	●	SEI stream with both buffering period and picture timing present (HRD Compliant)	Coded bit rate will be auto-detected	TS will carry PTS and DTS as coded by the SEI timing information.

**Auto detection**     The stream bit rate is calculated as follows.

$$Bitrate = \frac{File\ Size}{(Number\ of\ Frames / Frame\ Rate)}$$

## Starting the Program

The program can be started by selecting the Tektronix Multiplexer option from the Start > Programs menu or by double-clicking on the Tektronix Multiplexer shortcut on the desktop.

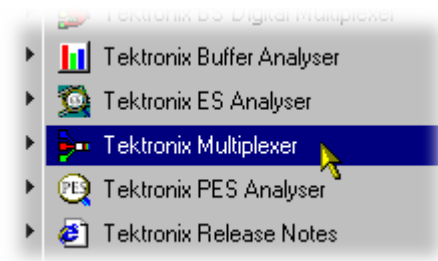

**Initial Appearance**     Once the program has started and is ready for use, it will open a Main Window that looks as follows.

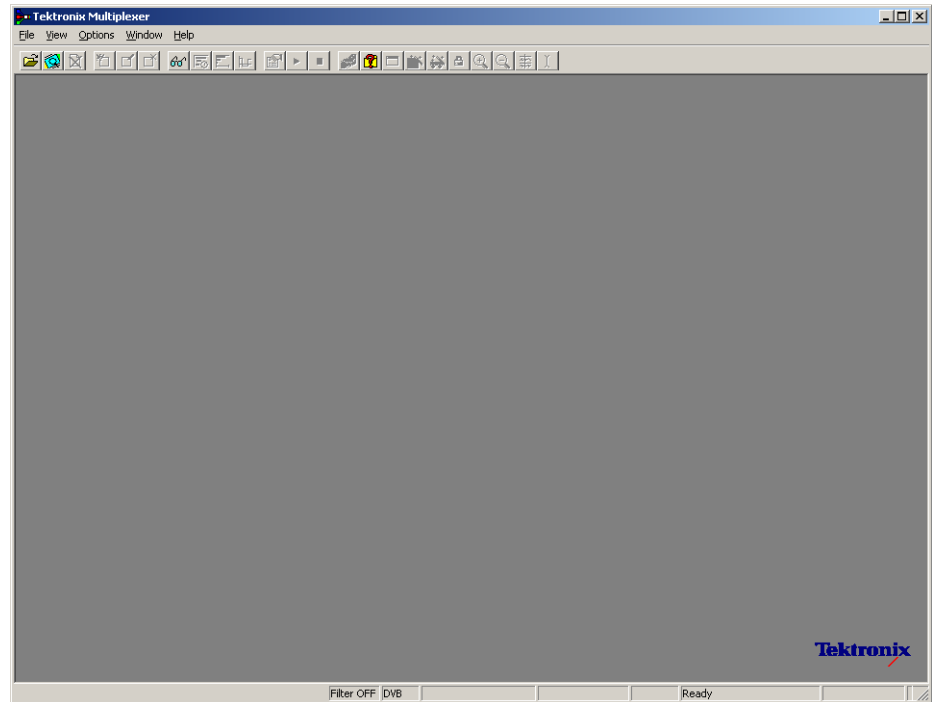

Use the View menu to select a standard that will be used to interpret transport streams, and then open a transport stream file or import a multiplex configuration file.

**Initial Menu Options**

When the application is opened, you are presented with options relevant only to opening new or existing multiplex files. Options that are not relevant at this time are inactive (grayed out).

**File Menu Options.** Table 8–2 lists the options available in the initial File menu.

**Table 8–2: File menu options**

Command	Function
New	Opens new multiplex configuration file.
Open	Opens an MPEG file for use. The program opens the file selection dialog box allowing you to choose the required file.
Examine TS	Opens the Examine TS window, which allows a brief summary of the stream to be viewed before it is subjected to full analysis.
Close	(Currently disabled - see page 8-17.)
Import...	Opens a previously saved multiplex configuration file.

**Table 8-2: File menu options (Cont.)**

Command	Function
Export	(Currently disabled – see page 8-17.)
Export As	(Currently disabled – see page 8-17.)
1 <filename> 2 <filename> 3 <filename> 4 <filename>	A list of the four most recently used files. If the program has recently been installed the list may be empty or hold less than four files.  Selecting a file name opens that file for use.
Exit	Finishes running the program.

**View Menu Options.** Table 8-3 lists the options available in the initial View menu.

**Table 8-3: View menu options**

Command	Function
Interpretation	Opens the Stream Interpretation dialog box. This allows the scripts to be used in stream analysis to be selected.
Event Log	Opens the Event Log window.
Toolbar	Displays or hides the Toolbar.
Status Bar	Shows or hides the Status Bar.

A check mark next to an option indicates that the object is currently visible.

## Scripts

SI scripts are necessary to enable SI table and descriptor data to be analyzed successfully. Scripts are used to enable analysis of SI data dictated by the various international standards, for example, MPEG-2, DVB, ATSC, and ISDB.

Essential scripts are installed and enabled using the Stream Interpretation dialog box. In the absence of any enabled scripts, only the PAT table will be analyzed; all other data will be presented as private data.

If a suitably configured script is selected and enabled before a stream is opened, custom data will be analyzed when the stream is opened. If the script is not selected or enabled, the stream will be analyzed, but any custom data will be reported as either an error in the stream configuration or as an elementary stream PID.

Scripts can be selected and enabled only when no files are open. The Stream Interpretation dialog box is available when a file is open, but all activity is disabled.

Note that a script file will not be used for analysis until:

- It is present in the Scripts text box in the current analysis mode.
- It is successfully enabled by closing the Stream Interpretation dialog box using the OK button.

## Handling Scripts

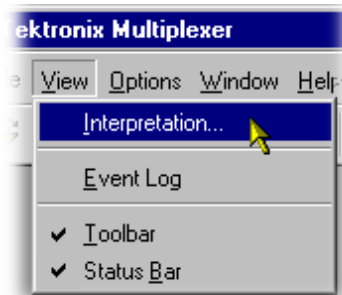

To open the Stream Interpretation dialog box, with all files closed, select View > Interpretation.

The Stream Interpretation dialog box is displayed as shown.

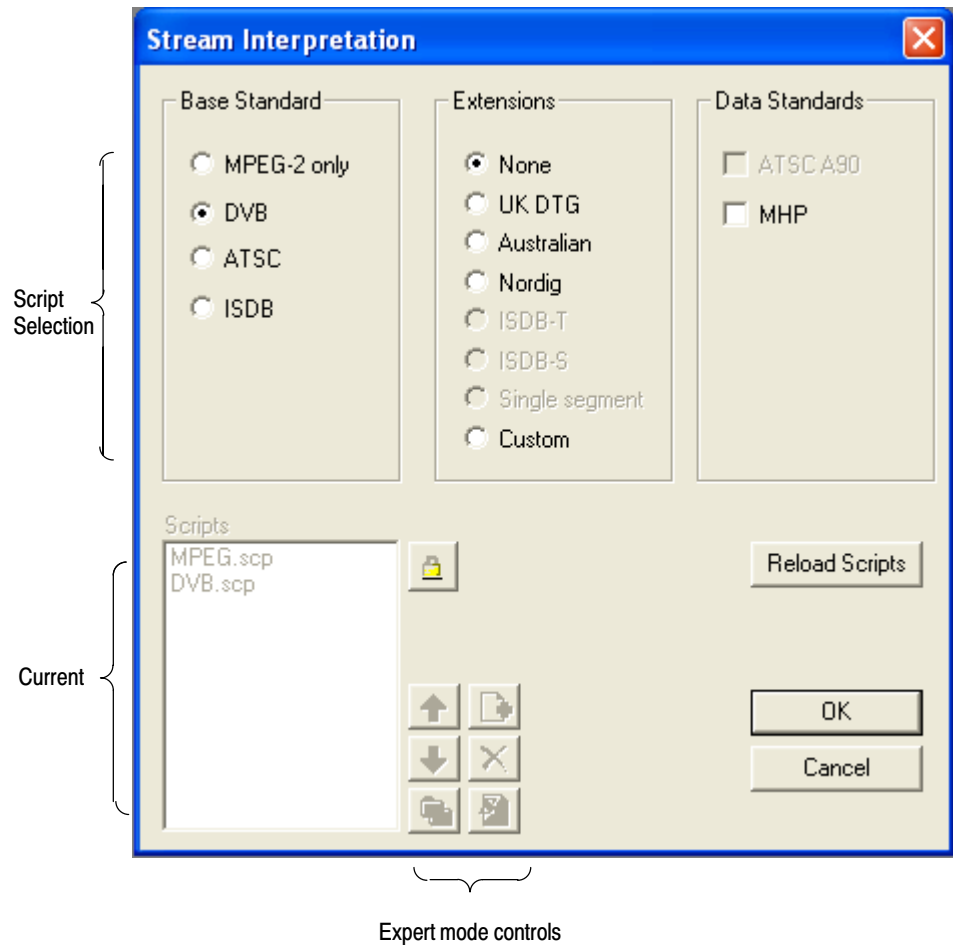

The top half of the dialog box is concerned with selecting scripts. The text box (Scripts) lists the scripts currently selected. The area adjacent to the text box is dedicated to Expert mode controls.

### Selecting Scripts

The selection area of the Stream Interpretation dialog box is best viewed and used from left to right.

The Base Standard section allows the MPEG-2, DVB, ATSC, or ISDB standard to be selected for analysis.

**MPEG-2 only**      Interprets and analyzes the packets in conformance to the MPEG-2 standards.

**DVB**      Interprets and analyzes the Transport Stream Packets according to the specifications of the DVB and MPEG-2 standards.

ATSC	Interprets and analyzes the Transport Stream Packets according to the specifications of the ATSC and MPEG-2 standards.
ISDB	Interprets and analyzes the Transport Stream Packets according to the specifications of the ISDB and MPEG-2 standards.

The selected standard will dictate the availability of the remaining options in the Extensions and Data Standards sections.

The Extensions section allows country-specific extensions to be added to the basic standard scripts. If None is selected, only the standard scripts are listed in the Scripts text box. The remaining country-specific extensions add extra scripts to the current listing. As with the Base Standard, the choice of Extensions option will dictate the availability of the options in the Data Standards section. The Custom selection in the Extensions section allows users to include their own selection of scripts using Expert Mode controls.

The Data Standards section offers a choice of data-specific scripts.

Note that the scripts listed by default are those resident in the default installation directory (tektronix\scripts). Other directory locations can be specified in Expert Mode. All selections will be retained between sessions.

### Checking Syntax

Scripts are syntactically analyzed when the OK button is selected. They are also checked when the application is opened. A fault in the syntax of a script will not necessarily prevent a stream from being analyzed, but it may result in incomplete analysis of the stream.

Scripts listed in the Scripts text box will not be used for stream analysis until they have been successfully checked (the application has been opened or the Stream Interpretation dialog box has been closed with no script-related error messages issued).

An intermediate check of scripts listed in the Scripts text box can be made by selecting the Reload Scripts button. This performs the same action as the OK button but leaves the dialog box open.

Syntax errors will be indicated and reported in the *Event Log* (see page 8–63).

**Export Mode**





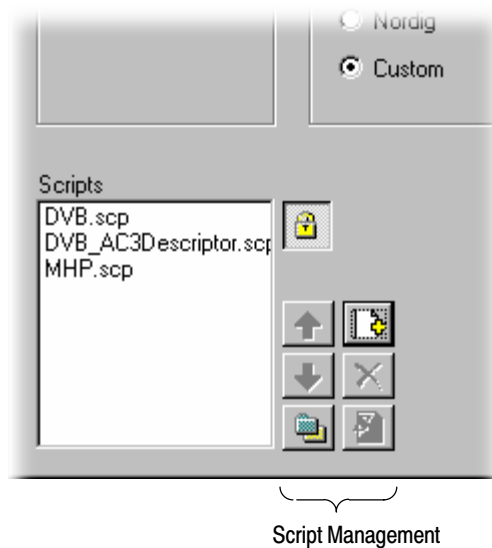

Expert Mode allows you to select and customize the scripts to be used in stream analysis and multiplexing. Note that when the expert mode is selected, the Custom extension option is automatically selected and the management buttons are enabled. In Expert mode, all scripts become available to be added to the script list. The scripts will be checked and loaded, ready to be used for analysis, when the OK button is selected.





The script management buttons act on the scripts currently listed in the Scripts text box.

**Table 8-4: Script Management**

Buttons	Function
 	Script files are parsed in the order that they are listed; in some circumstances this may be important. To move a file in a list, highlight the file name and select the Up or Down arrow button as required. Each press of the button will move the file up or down one place in the list until it reaches the top or the bottom.
	Add a script to the list: A standard Windows file selection dialog box is opened. The default file extension is .scp. Select the required file. The selected script will be added to the bottom of the list. If necessary, move it using the Up and Down buttons.  Scripts can be loaded from any directory.
	Delete the highlighted script.



**Table 8-4: Script Management (Cont.)**

Buttons	Function
	<p>Change scripts default directory: by default, all scripts are found in a default directory created during installation (tektronix\scripts). This button can be used to set a different default directory.</p> <p>Note that all scripts supplied by Tektronix in the default installation are installed in a single directory; as long as this directory is designated as the default directory, they will work satisfactorily.</p>
	View highlighted script with the associated application; by default, script files are associated with the ScriptPad utility.

For a script file to be viewed successfully, the file extension (.scp) must be associated with a text editor in the Microsoft Windows environment. The MPEG Test System installation program by default associates a script editing utility called ScriptPad; you can use another text editor, for example, Microsoft Notepad, if preferred. ScriptPad is a simple script editor that can be installed with the MPEG Test System. Scripts can be viewed and edited as required (depending upon the file permissions).

## Opening a Stream

Two options are available when opening a stream for multiplexing: to open an existing stream or to open a previously prepared multiplex configuration file.

Three options are available when preparing a stream to be multiplexed:

- Create a new null stream (using File > New)
- Open an existing stream
- Import a multiplexer configuration file

## Opening an MPEG Stream

Any file holding a recorded or synthesized sample of a stream that conforms to the relevant standards can be opened and used as a basis for a new multiplex. Note that the Examine TS option (see page 8-64) can be used to preview stream.

Some nonconformant streams can be opened, although, only the conformant parts can be edited usefully. Any tables that are carried in a conformant PID and have the correct syntax will appear in the output transport stream, as will any elementary streams (whether referenced by a table or not) which are in the input transport stream.

To open a file holding a transport stream, select the File > Open. If the required file is in the list of recent files, it can be opened from the list using the Open File dialog box.

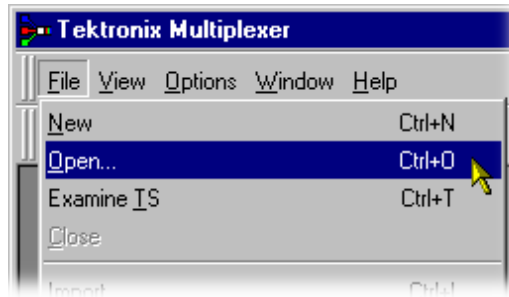

Alternatively use the Ctrl+O keyboard shortcut or drag the file from Windows Explorer and drop it into the Multiplexer window. A shortcut button is available on the Toolbar for opening a file.



### Opening Multiplex Configuration Files

Any file holding a recorded or synthesized sample of a stream, which conforms to the relevant standards, can be opened. Many nonconformant streams can be opened provided that the PAT, PMT, and MGT tables correctly specify all the other tables and their PIDs.

Multiplexer is used for generating both conformant and nonconformant streams. Having generated a nonconformant stream, it may not be possible to successfully open it again in Multiplexer.

The specification for a new transport stream may be saved to a multiplex configuration file. This also saves time for opening large MPEG files, since the specification contains the results of the analysis from opening the original MPEG file.

---

**NOTE.** *The multiplex configuration file does not contain a copy of the transport stream; instead it refers to the original MPEG file by the full path name. Deleting or moving the MPEG file will result in a dialog box prompting for the new location of the file.*

---

Double-clicking on a \*.muxml or \*.mux file in Windows Explorer will open the file in a new instance of Multiplexer.

**Importing a File.** Importing opens a multiplex configuration file and the MPEG file on which it is based.

To open a previously exported multiplex configuration file, select the File > Import. If the required file is in the list of recent files, it can be opened

from the list to save using the Import file dialog box.

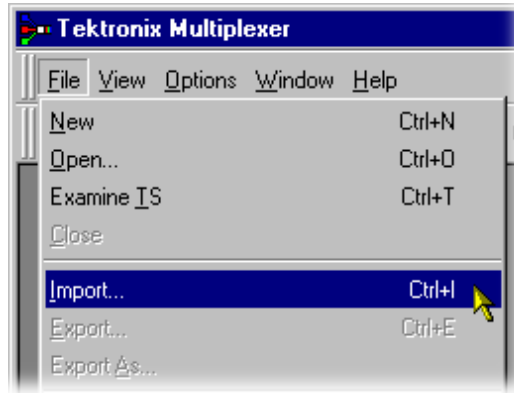

Alternatively use the Ctrl+I keyboard shortcut or drag the file from Windows Explorer and drop it into the Multiplexer window.

---

**NOTE.** Multiplexer reads the name and location of the MPEG file from the multiplex configuration file and then opens it automatically. The previously stored changes in the configuration file are applied to the display.

---

Note that the import dialog box offers a choice of file types: \*.muxml, \*.mux and \*.\*.

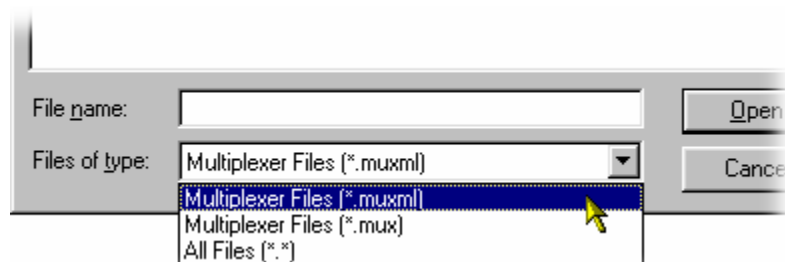

### Initial Stream Analysis

The Navigator Tables view window is opened as soon as a file is opened or imported. The program now starts to analyze the file with the loaded scripts to determine what tables are present.

As the file is analyzed, the Top Levels of the Transport Structure diagram are drawn in the Navigator window. The rightmost pane in the Status Bar at the bottom of the program window shows the progress of analysis.



Files that are imported require less processing because they were analyzed in the session from which they were exported.

### **What to Do Next**

The file can now be manipulated to form a specification with which to synthesize a new transport stream. Tables, elementary streams, and PIDs are viewed and selected using the Navigator views. The components of any table selected in the Navigator views are viewed and selected using the Section View window.

Tables, Programs and PIDs can be added and modified using the wizards provided or manually. A selection of menu options is provided to facilitate manipulation of the data.

The Multiplex menu has options to inhibit and reenale forced conformance to the selected standards.

Having manipulated the file, a transport stream can be synthesized to the new specification by the multiplex engine. The engine is started from the Multiplex menu or using a toolbar button. The source file is used as reference data by Multiplexer and the output written to a different file.

The illustration on page 8–15 gives an overview of the Multiplex process.

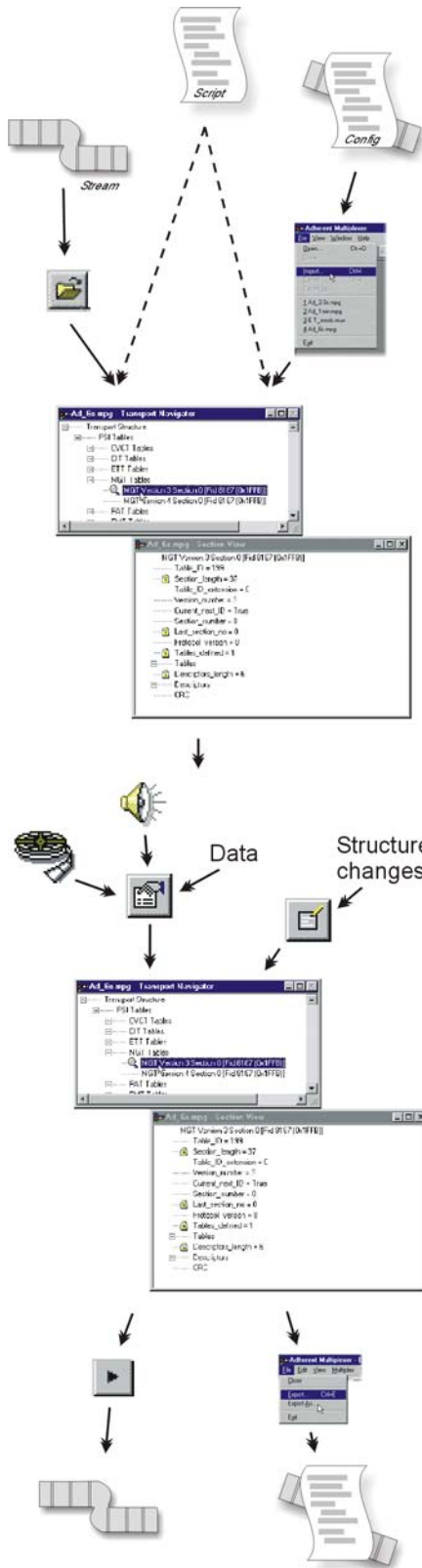

### Open/Import

Any file holding a recorded or synthesized sample of a stream that conforms to the relevant standards can be opened. See *Opening an MPEG file*.

Importing opens a multiplex configuration file and the MPEG file on which it is based.

See *Importing a File*, page 8-12.

### Transport Structure Demultiplex

As the file is analyzed, the Top Levels of the Transport Structure diagram are drawn in the Transport Navigator.

See *Initial Stream Analysis*, page 8-13.

### Transport Structure Modifications

The file can now be manipulated to act as the specification to synthesize a new transport stream. The tables and elementary streams are viewed and selected either with the aid of Wizards or in the Navigator windows.

### Output/Export

The Multiplex Engine synthesizes a new transport stream and writes it to an MPEG file.

To ensure that the specification for any synthesized stream can be reused, it can be saved to a multiplex configuration file.

See *Multiplexing Transport Streams*, page 8-119.

## Closing Files

To close the files, select File > Close. This will close both the MPEG file and any multiplex configuration file that is open.

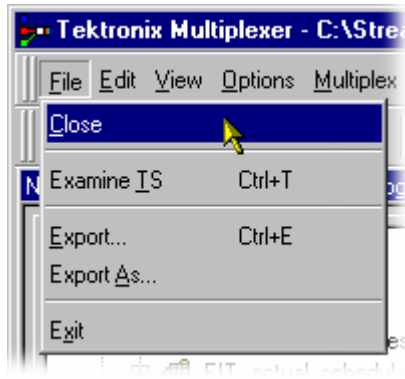

A shortcut button is also available on the Toolbar for closing a file, which has a standard file close symbol.



If a multiplex configuration file has been edited, and the changes not exported, the program will ask if the file should be saved.

Select Yes to export the file, No to close the file without saving, or Cancel to undo the close command and keep the file open.

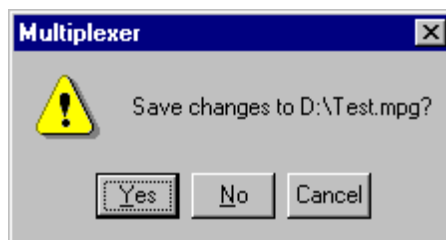

# Menus and Controls

This section describes the various menu options, toolbar controls, status bar, icons, and user interface.

## Menu Options

The following pages describe all of the menu options. Since many of the options are context sensitive, they will be available only when their function is appropriate for the selected display or window element. When a menu option is not available, the option is grayed out.

**File menu options** Table 8–5 lists the options available in the File menu.

**Table 8–5: File menu options**

Command	Function
Close	Closes the current file. This option is available as soon as analysis starts. If the wrong file is being opened, or the wrong options are selected, selecting this option will abandon the analysis and close the file.
Examine TS	Opens the Examine TS window, which allows a brief summary of the stream to be viewed before it is subjected to full analysis.
Export...	Exports the current multiplex specification in a form that can be imported even if it no longer generates a conformant transport stream. This option is disabled when no file is open.
Export As...	Exports the current file, as above, and allows a different file name to be specified. This options is disabled when no file is open.
Exit	Closes any file that is open and terminates the program.

**Edit menu options** Table 8–6 lists the options available in the Edit menu.

**Table 8–6: Edit menu options**

Command	Function
Add	Adds a table/section/loop to the currently selected item in the Navigator or Section View.
Modify	Edits the information in the currently selected field or item.
Delete	Deletes the item currently selected.
Cut	Cuts the current selection from the Window.
Copy	Copies the contents of the current selection to the clipboard.
Paste	Pastes data from the clipboard to the part of the transport structure that holds that type of data.
Export Payload	Extracts and exports the payload of the source transport stream PID in the form of a simple data file.
Export Elementary Stream	Removes the transport stream PID and PES headers and exports the remaining information as a simple data file.
Export Section Data	Extracts and exports section data. The created file can be imported as ES using Multiplexer’s Add function or as SI using the Import Section Data option (see next option).
Import Section Data	Imports SI data from a file and analyzes it. The section is added to the Navigator view.

**View menu options** Table 8–7 lists the options available in the View menu.

**Table 8–7: View menu options**

Command	Function
Interpretation	Displays a read-only dialog box for viewing scripts that have been selected for analysis (see also <i>Initial Menu Options</i> , page 8-5).
Section View	Opens the window and displays the table section currently selected in the Navigator view.
Event Log	Displays the list of events that are recorded in the Event Log.
Component Bit rate	Displays a graphical comparison of the stream bit rates.
Component Duration	Displays a graphical comparison of the stream component durations.
Available Bit rate	Displays a graphical view of the bit rate in the stream.
Properties	Opens a properties dialog box for editing the currently selected item in the Transport Navigator window.



**Table 8-7: View menu options (Cont.)**

<b>Command</b>	<b>Function</b>
Zoom In	Zooms in the Available Bit rate and Component Duration views.
Zoom Out	Zooms out from the Available Bit rate and Component Duration views.
Synchronize	Synchronizes zoom levels of the Available Bit rate and Component Duration views (toggle).
Show Cursor	Shows or hides the cursor in the Available Bit rate and Component Duration views.
Toolbar	Shows or hides the Toolbar.
Status Bar	Shows or hides the Status Bar.

**Options menu options**

Table 8-8 lists the options available in the Options menu.

**Table 8-8: Options menu options**

<b>Command</b>	<b>Function</b>
Display Filter	Opens the SI Filter dialog box.
Single Section View	Selects single or multiple section view. When disabled, multiple section views can be opened.
Program Wizard	Invokes the Program wizard.
Transport Wizard	Invokes the Transport wizard.
Scan Settings	Opens the Scan Settings dialog box.

**Multiplex menu options**

Table 8–9 lists the options available in the Multiplex menu.

**Table 8–9: Multiplex menu options**

Command	Function
Start	Starts the Multiplex Engine, to synthesize a new transport stream file.
Stop	Aborts multiplexing. The output file is closed and contains all of the data synthesized up to the point where the multiplex engine stopped. This option is available only while the Multiplex Engine is running.
Standard Mode	Enforces conformance to the selected standards when editing some fields that can be generated automatically.
Expert Mode	Inhibits the above conformance checking so that nonconformant files may be created.
Report	Provides the option of printing all or part of the transport structure to either a file or a printer.
Seamless	When enabled, the program specified in Seamless Settings is processed and made seamless.
Seamless Settings	Opens a dialog box in which the Make seamless parameters are specified.

**Window menu options**

Table 8–10 lists the options available in the Window menu.

**Table 8–10: Window menu options**

Command	Function
Cascade	Cascades the open windows when Options > Single Section View is disabled.
Tile	Tiles the windows horizontally when Options > Single Section View is disabled.
Arrange Icons	Aligns icons of any minimized windows at the bottom of the program’s main window.
1 <window title> 2 <window title> 3 ... etc.	Makes the named window active, putting it on top of any windows that had been hiding all or part of it.

**Help menu options** Table 8–11 lists the options available in the Help menu.

**Table 8–11: Help menu options**

Command	Function
About Multiplexer	Opens a dialog box that displays the program version number and license number.

## Toolbar

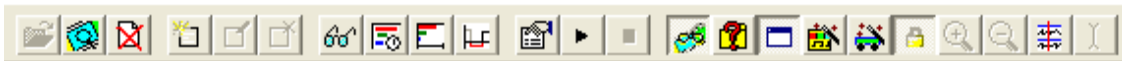

Toolbars provide a set of convenient shortcuts for the more frequently used menu options. The buttons are context sensitive and are enabled or disabled depending upon the currently highlighted view or the action being performed.

The Toolbar can be hidden from view by selecting View > Toolbar.

## Status Bar

The Status Bar may be hidden from view, but when displayed it is always at the bottom of the main window. For example:

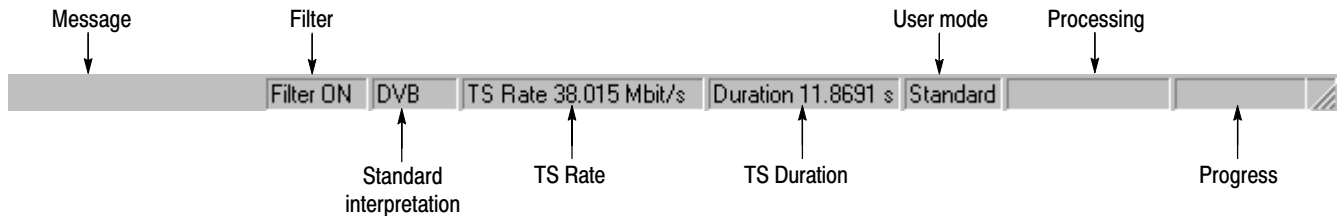

The following information is displayed from left to right on the Status Bar:

Message Field	Provides a description of any button or menu option over which the cursor pointer is placed. Other noncritical messages may also be shown.
Filter Status	Indicates the status (On/Off) of the SI Filter.
Standard Interpretation	Indicates the selected standard with which the file is processed: MPEG-2, ATSC, DVB, or ISDB.
TS Rate & Duration	Shows the transport stream rate and the duration at that rate. A default rate is displayed during initial analysis.
User Mode	Shows User mode selected: Expert or Standard. The Standard mode prevents changes to certain fields. The Expert mode enables editing.
Processing Status	Indicates the progress (%) during initial analysis and multiplexing.
Processing Progress	Indicates the progress during initial analysis and multiplexing.

The Status bar can be hidden from view by selecting View > Status Bar.

---

**NOTE.** The status bar (Standard interpretation) displays ISDB-T SS whenever the ISDB interpretation with Single segment extension is selected.

---

## User Interface

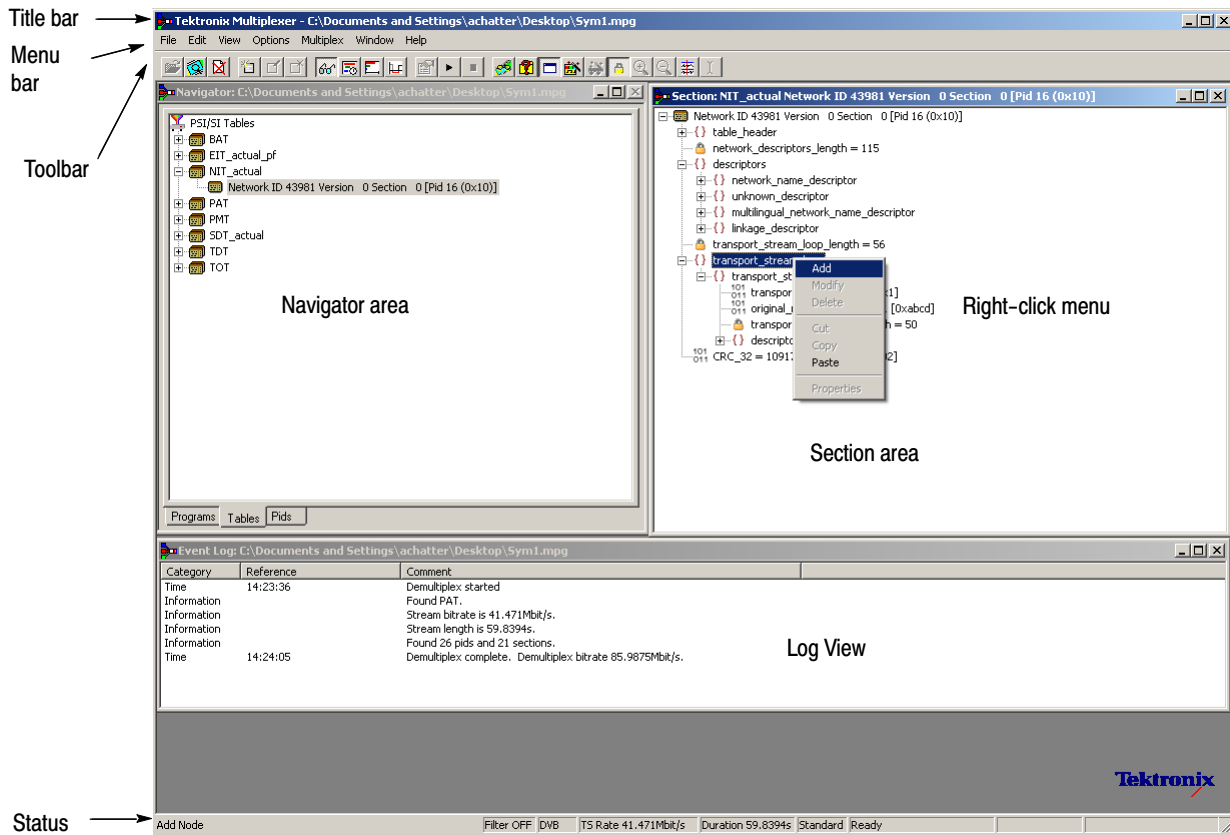

**NOTE.** The Menu Bar contains the complete selection of options available in the Multiplexer. Shortcuts to options are available through the toolbar and context-sensitive shortcut menus.

















**Icons** Icons are used throughout the Multiplexer user interface to assist you to identify components and make visual links with toolbar shortcuts and menu options.

The following table lists all the icons used.

**Table 8-12: Icons**

Icon	Description	Icon	Description
	About Multiplexer		Program
	Add		Program Group
	Audio stream		Program Wizard
	Bit field		Properties
	Close		Report
	Container/Loop		Seamless
	Copy		Seamless Settings
	Current selection		Section
	Cut		Section timing
	Delete		Section View
	Display Filter dialog box		Single window
	Examine Transport Stream		Standard mode
	Exit		Start
	Expert mode		Stop
	Export		Table

**Table 8–12: Icons (Cont.)**

Icon	Description	Icon	Description
	Export As		Transport Stream icon
	Export Elementary Stream		Transport Wizard
	Export Payload		Unknown
	Export Section Data		Video stream
	Import Section Data		View Event Log
	Modify		View Component Duration
	New		View Component Bit rate
	Open		View Available Bit Rate
	Paste		

## **Cutting and Pasting**

Table types, sections, and PIDs can be cut, copied, and pasted using the Windows clipboard. Only one selection can be held on the clipboard at a time. Alternatively, a selection can be dragged and dropped using the mouse.

**Cutting a Selection to the Clipboard.** A selection (table type, section or PID) can be deleted and automatically placed on the Windows clipboard. It can then be pasted to a different file or back into the current file. Highlight the selection in the Navigator Tables or PIDs view and select Edit > Cut or use the Ctrl+X keyboard shortcut.

**Copying a Selection to the Clipboard.** A selection (table type, section or PID) can be copied to the Windows clipboard. From the clipboard, it can be pasted to a different file or back into the current file.

Highlight the required selection in the Navigator Tables or PIDs view and then select Edit > Copy or use the Ctrl+C keyboard shortcut.

**Pasting a Selection from the Clipboard.** More than one instance of Multiplexer can run concurrently on a machine. A selection (table type, section, or PID) can be pasted from the clipboard into any open transport stream file. The contents of the clipboard are not affected by the paste operation, so the section can be pasted to many files and more than once to the same file.

Activate the Navigator Tables or PIDs view of the required transport stream file (that is, in an instance of Multiplexer). Then select Edit > Paste or use the Ctrl+V keyboard shortcut.

The section/version is always appended to the end of the list under the appropriate table. Program/version numbers are automatically created. If the table is not present in the multiplex configuration, it will be created automatically.



**Dragging and Dropping**

A concept familiar to Windows users is “drag and drop” in which files can be highlighted by clicking on them with the mouse and then dragged and dropped to a new location, either in the same application or across applications.

In Multiplexer, the main uses of the drag and drop feature are to modify multiplexes and to build new ones.

Elements can be dragged within Multiplexer, or from the Multiplexer Browser, Windows Explorer or other instances of Multiplexer.

Program references and numbering will be automatically added and/or updated when a new program is dropped onto the Navigator Programs view.

---

**NOTE.** *Only the MPEG aspects of the transport structure are updated. Tables specific to DVB and ATSC are not updated.*

---

**Manipulation in Program view.** The following manipulations are available in the Program view:

- When using Navigator Program view, a program can be copied or dragged. The program can be dropped only on the transport stream node of the Program view.
- Only the standard MPEG elements are copied, namely the PAT entry, the PMT section and the elementary streams. Standard dependent information is not copied, for example, DVB SDT.
- Where a conflict occurs with the target, new values will be allocated for the Program and PID numbers.
- Elementary streams can also be dragged and dropped between Program Views. They can be dropped only onto the elementary stream root node.
- An elementary stream may have a stream type, a component tag and descriptors associated with it; this information is retained during a drag and drop in the program view. The program view displays this information when the properties dialog box is activated.



# Wizards

In the Navigator Programs view, wizards provide you with a step-by-step approach to building streams to be multiplexed by offering defaults for PSI/SI and the opportunity to include user-selected programs. The standard previously selected in the Interpretation dialog box will dictate which PSI/SI components are offered.

There are two major wizards: the Transport Wizard and the Program Wizard. Other minor wizards may be opened by these major wizards or they may be opened in a new window to facilitate specific tasks, such as adding EIT information. When configuring a new multiplex, the Transport Wizard is opened, followed by the Program Wizard; although, on completion of the Transport phase, an opportunity to exit the wizard process is offered before the Program Wizard opens. For some detailed operations, only the appropriate wizard can be opened.

At their most basic level, wizards open, in a logical order, the property dialog boxes that are available when building a stream manually.

The following paragraphs provide a step-by-step description of the wizards.

## Wizard Controls

The following control buttons are provided on the wizard dialog boxes where relevant:

Next	Retain changes made using this dialog box and move to next dialog box.
Back	Discard changes made using this dialog and return to the previous dialog box.
Cancel	Exit the wizard and discard all changes.
Finish	Exit the wizard and implement all changes.

## Transport Wizard

Toolbar icon: 

The Transport wizard allows you to easily create a basic stream populated with the PSI/SI necessary to hold program information. It may also be opened when PSI/SI is to be added to an existing stream.

## Creating a New Transport Stream

The following steps show the screens used in the creation of a DVB stream.

---

**NOTE.** When the Transport Wizard is used to populate a new stream, if the defaults in the various dialogs are retained, then the resulting stream will conform to the selected standard.

---

1. Open a new file; File > New.
2. Select the Program tab in the Navigator view.



3. Select and highlight the Transport Structure element; at this stage in the creation of a new stream, this will be the only element visible in the Program Navigator view.
4. Select Add from the shortcut menu.

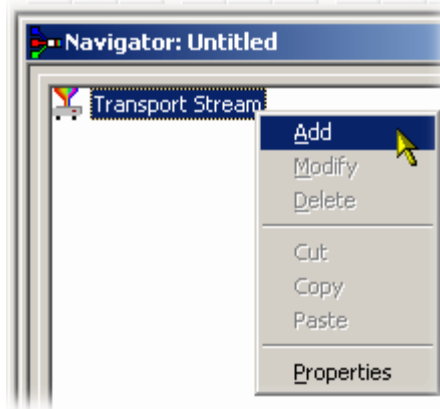

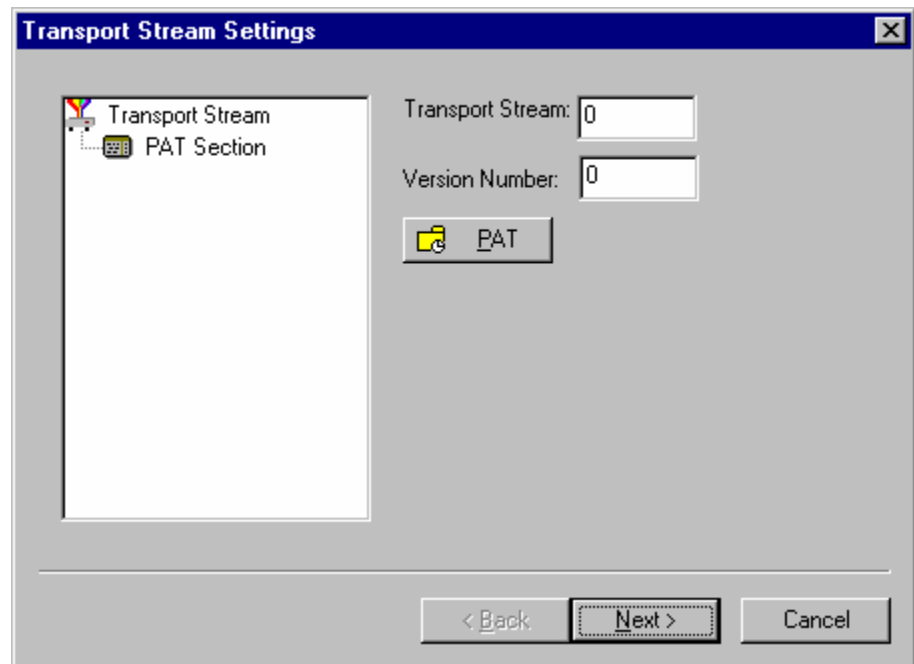

The Transport Stream Settings dialog box allows you to set up the transport stream identity (part of the PAT section) and version. Adjustments can also be made to the PAT timing, if required, by selecting the PAT button.

PAT timing - see *Editing PSI/SI Table Properties*, page 8–92.

---

**NOTE.** You cannot add a PAT with the ISDB interpretation and Single segment extension selected. When you click Add, Add a Program wizard is displayed instead of the Transport Stream Settings.

---

5. Select Next to move to the Optional Tables dialog box.
6. This dialog box allows you to include, and if required, configure basic PSI/SI information.

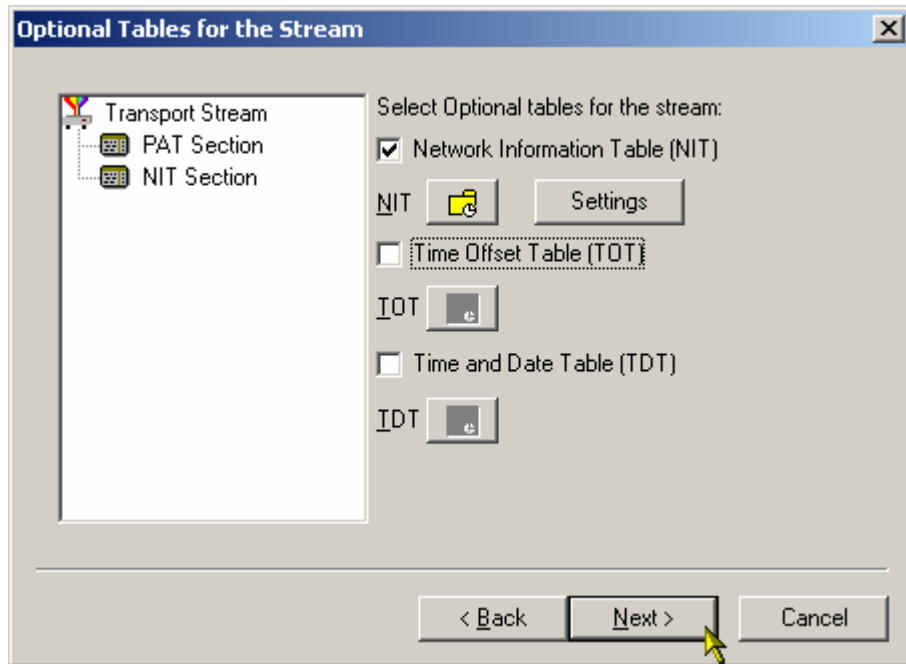

As the check box next to each table is enabled, the table name is added to the graphical representation on the left. The associated buttons are also enabled to allow timing or other aspects of the table to be modified.

NIT, TOT, and TDT Timing - see *Editing PSI/SI Table Properties*, page 8–92

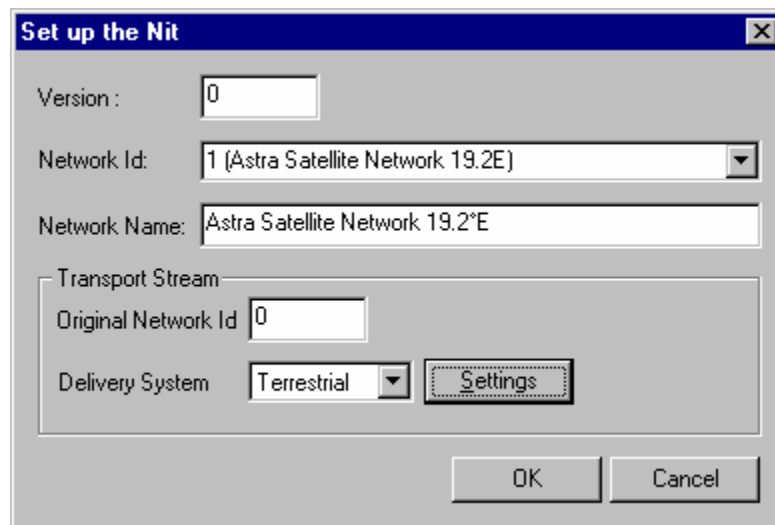
**NIT Settings**

The image shows a dialog box titled "Set up the Nit" with a close button (X) in the top right corner. The dialog contains the following fields and controls:

- Version :** A text input field containing the value "0".
- Network Id:** A dropdown menu showing "1 (Astra Satellite Network 19.2E)".
- Network Name:** A text input field containing "Astra Satellite Network 19.2°E".
- Transport Stream:** A section containing:
  - Original Network Id:** A text input field containing "0".
  - Delivery System:** A dropdown menu showing "Terrestrial".
  - Settings:** A button with a dotted border, located to the right of the Delivery System dropdown.
- OK** and **Cancel** buttons are located at the bottom right of the dialog.

To set up the Network Information Table (NIT), enter or select the required values and select the OK button. Note that if a Delivery System other than Undefined is selected, an additional settings dialog box becomes available, specific to the Delivery System chosen.

7. Select Next to move to the Transport Wizard Complete dialog box.

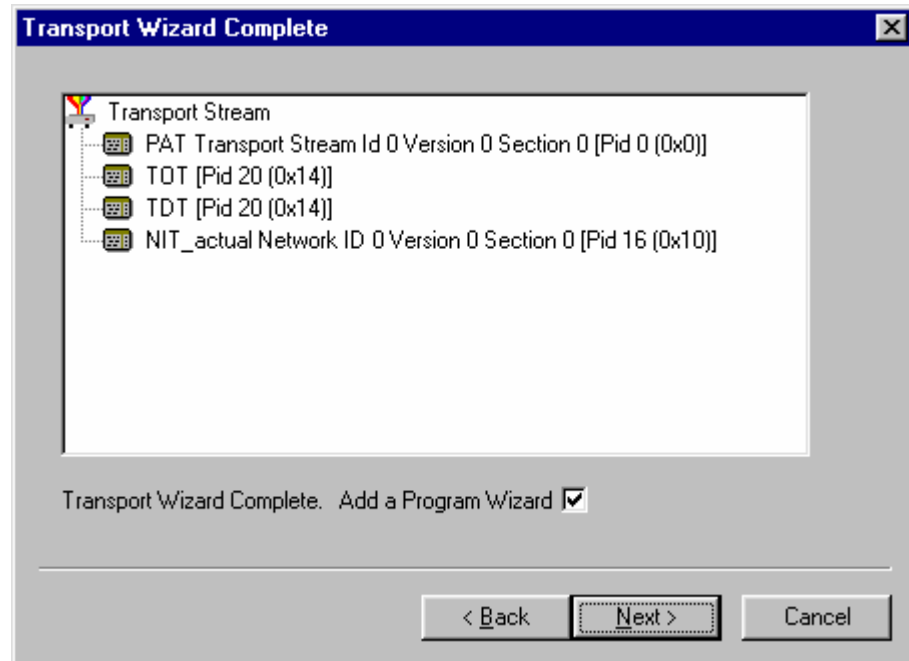

This dialog box allows you to review the changes made by the wizard before confirming the process.

The process can be cancelled, thereby losing all changes, by selecting the Cancel button.

At this stage in the creation of a new multiplex, if you want to add programs, leave the Add Program Wizard check box enabled and select Next. If you want to add them by some other means, clear the Add a Program Wizard check box. The Next button label will change to Finish, which allows you to exit the wizard and implement all changes.

When the Transport Wizard has closed, note that the Navigator views are updated with the new PSI/SI.



## Program Wizard

Toolbar Icon: 

The Program Wizard allows you to add programs as required to a stream that is already populated with basic PSI/SI. Each use of the Program Wizard allows the addition of one program. Adding more programs requires the wizard to be opened each time.

If a new stream is being created, the Transport Wizard offers an opportunity to open the Program Wizard. Alternatively, in the Navigator Programs view, highlight the Programs node and select Add from the shortcut menu.

### Adding a Program to a Transport Stream

To add a program to the transport stream, follow these steps:

---

**NOTE.** *If, when the Program Wizard is used to add programs to a stream, the defaults in the various dialogs are retained, the resulting stream will conform to the DVB standard.*

---

1. When you open the Program Wizard, either as a continuation of creating a new stream or as an attempt to add a new program, a dialog box similar to that shown below is displayed:

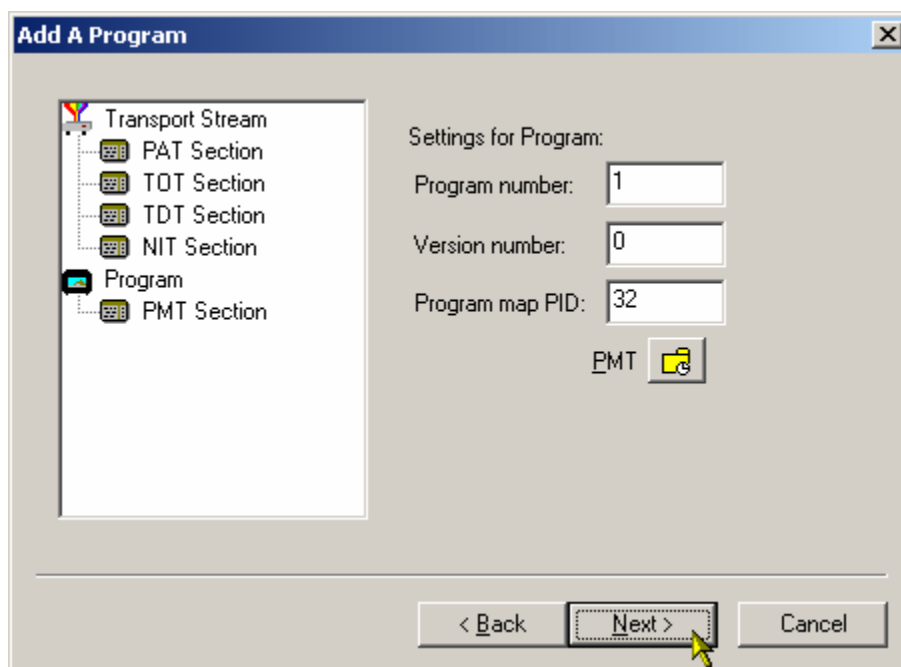

The values placed automatically in the three displayed fields will be the next in the sequence of programs. (In the example screen, the stream contains no prior programs, hence this is program number 1. PID 32 is used because that is the first free PID after the reserved PSI/SI PIDs.)

PMT Timing - see *Editing PSI/SI Table Properties*, page 8–92.

2. Select Next to move to the Add Service Description dialog box.

---

**NOTE.** *If ISDB interpretation with Single Segment extension is selected the program number starts from 8 (default). However, you can enter numbers from 1 to 7.*

---

### Service Description Dialog Box

The Service Description dialog box allows you to identify the Service Provider to be associated with a program.

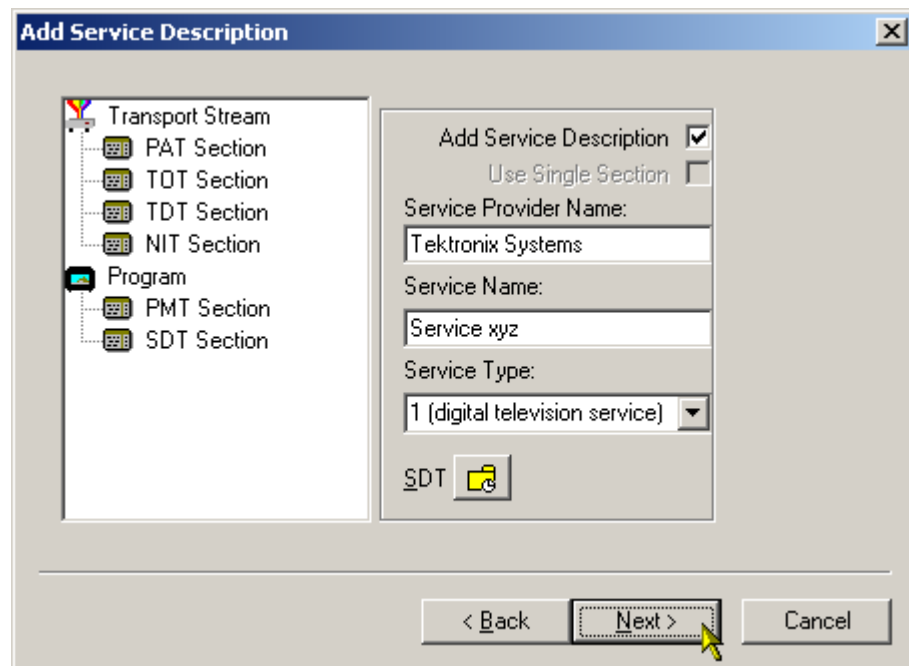

3. By default, the Add Service Description check box is clear. When it is enabled, a Service Provider Name and a Service Name must be entered and a Service Type selected from the drop-down list. If no details are provided, the section will still be created but the relevant descriptors will be empty.

Enabling the Use Single Section check box will cause the SDT descriptors to be added to the existing SDT section. If the stream contains no SDT section, the check box is disabled.

SDT timing - see *Editing PSI/SI Table Properties*, page 8–92.

4. Select Next to move to the Program Content dialog box.

**Program Content Dialog Box**

This dialog box allows you to compile a list of elementary streams to be associated with the program in the final multiplex.

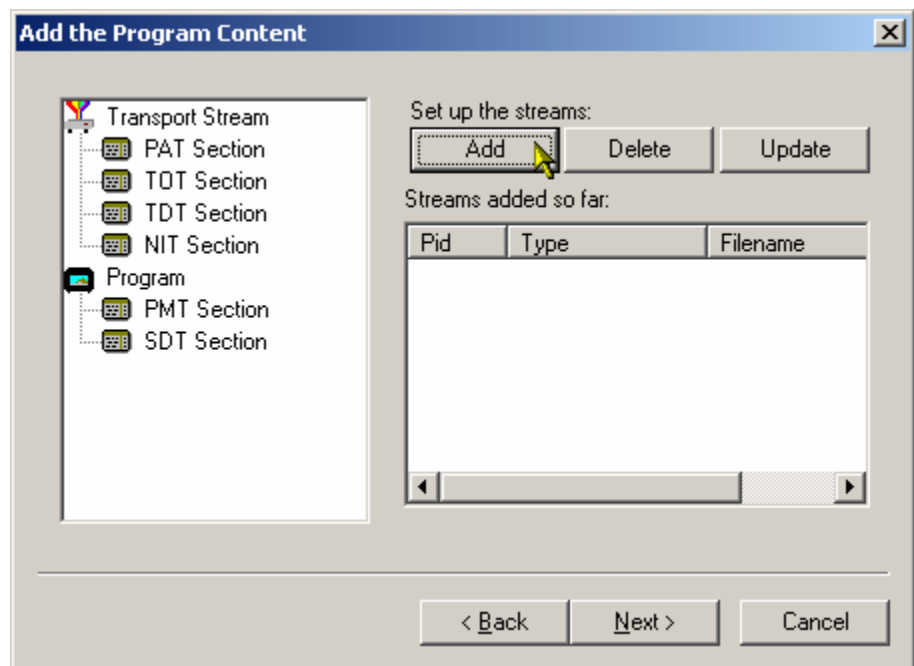

5. Select Add to display the Add Program Stream dialog box.

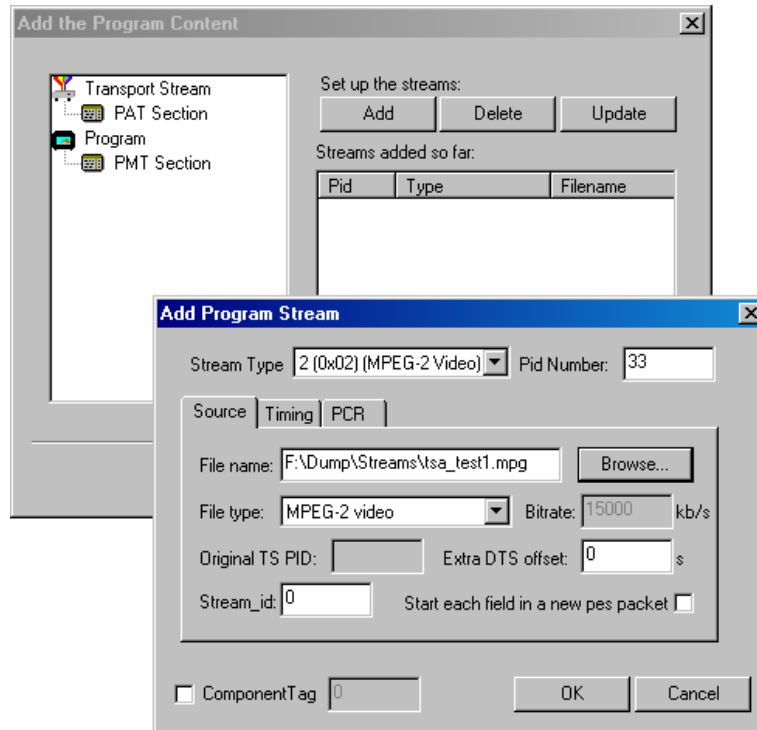

This dialog allows you to identify elementary streams to be included in the new multiplex. You must specify the PID and Stream Type of the new stream. A Component Tag can also be allocated.

If the Component Tag is enabled, it can be referenced by other tables, for example, the Event Information Table.

The dialog box consists of three tabbed pages that specify the source of the stream, its timing within the multiplex, and whether it should be carrying a PCR PID.

6. Select a Stream Type from the drop-down list.

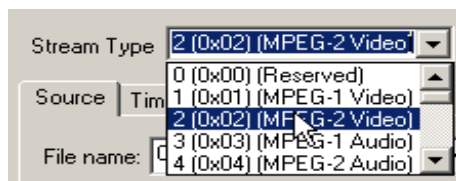

This will be the Stream Type allocated to the stream in the new multiplex.

---

**NOTE.** The Stream Type drop-down list displays the previously selected stream as the default type.

---

7. Allocate a PID Number in which the elementary stream is to be carried.

Pid Number:

8. Enable the Component Tag check box, if required. Enter a Component Tag number (0–255) in the enabled field.

**Source Tab.** The Source tab of the Add Program dialog box is used to select and specify elementary streams to be included in the new multiplex.

9. Enter an elementary stream File Name. You can enter it directly or use the Browse button to open a standard Windows file selection dialog box.
10. Select the File type of the selected stream from the drop-down list.
- If you select MPEG-2 video, the bit rate is detected automatically and displayed in the Bit rate field.
  - If you select H.264 video with SEI messages, the bit rate is detected automatically and displayed in the Bit rate field.
  - If you select H.264 video without SEI messages, the bit rate is not detected automatically.

When the selected file type does not match with the selected file name, an error message is displayed and you will have to reselect the correct file type.

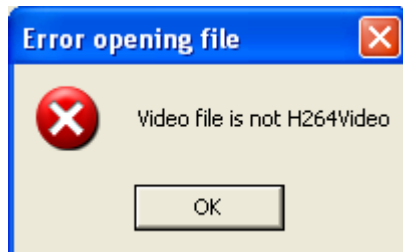

The remaining fields on this tab will be enabled or disabled depending on the Stream Type selected. Complete the enabled fields as necessary.

11. If you select H.264 video with SEI stream, a Suppress PTS/DTS insertion check box is displayed. The PTS/DTS insertion can be suppressed by selecting this check box.

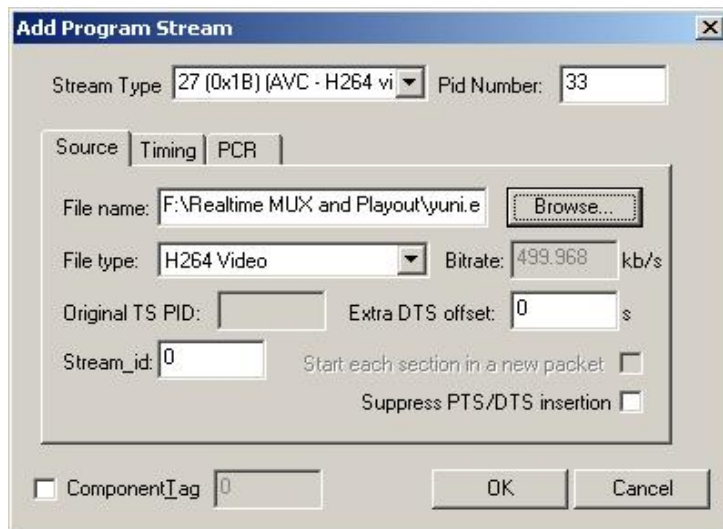

**Enter Bit rate for H.264 non-SEI streams.** You can assign the bit rate in the following ways:

- If you know the actual bit rate of the ES, enter the value in the Bit rate field. Select the frame rate from Frame rate box and click Accept. The entered bit rate will be displayed in the Bit rate field of the Source tab.

**Enter bitrate**

Cannot determine ES Bitrate.  
Enter the mean bitrate to be used for muxing or use the system to detect the bitrate

Bitrate:  kb/s

Enter the frame rate to be used for muxing.

Frame rate:  Frames/s

- If you want the Multiplexer to auto detect the possible bit rate, select the Frame rate and click Detect Bit rate. A progress bar is displayed giving the percentage of the scan completed and the bit rate is automatically filled in the Bit rate field of the Source tab.

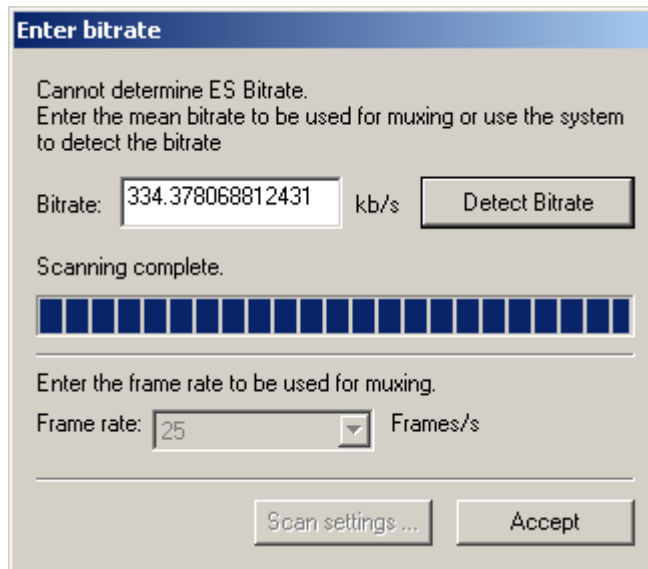

You can detect the bit rate by setting the scan value in the Scan settings dialog box. Select the options accordingly to scan the entire source file, bytes of the source file, or percentage of the source file.

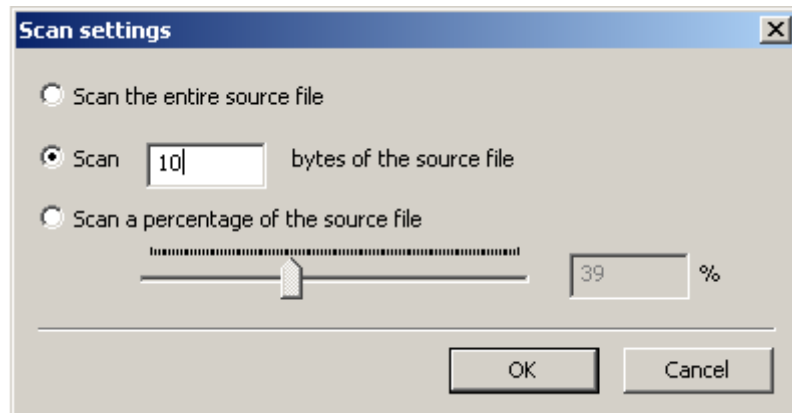



**Timing Tab.** The Timing tab of the Add Program dialog box is used to specify the portion of the new multiplex that the selected stream will use. The default start time is set to 0.002 s.

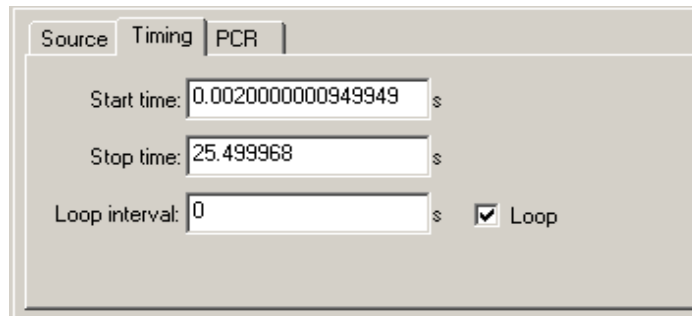

12. Complete the fields as required. The default settings assume that the stream is to be carried throughout the new multiplex, looping if necessary.

**PCR Tab.** The PCR tab of the Add Program dialog box is used to specify whether PCR information should be carried with the selected elementary stream or in a separate associated PID.

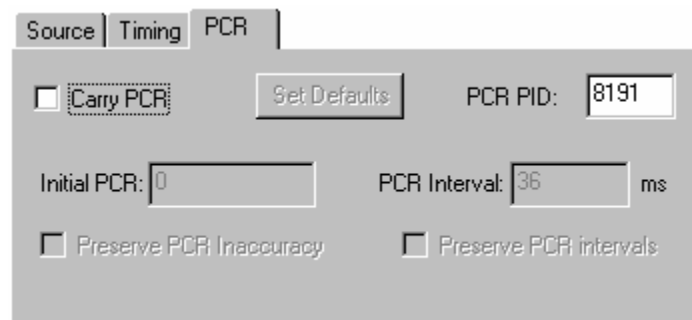

13. If the PCR is to be held in an associated PID, disable the Carry PCR check box and enter a PCR PID number.
14. If the PCR is to be carried with the stream, enable the Carry PCR check box and complete the remaining fields as required.

Set Defaults returns the settings to their initial values.

15. Select the OK button to complete adding an elementary stream to the listing in the Program Wizard.
16. More streams can be added using the Add button. Listed streams can be deleted using the Delete button. Details of listed streams can be modified using the Update button.

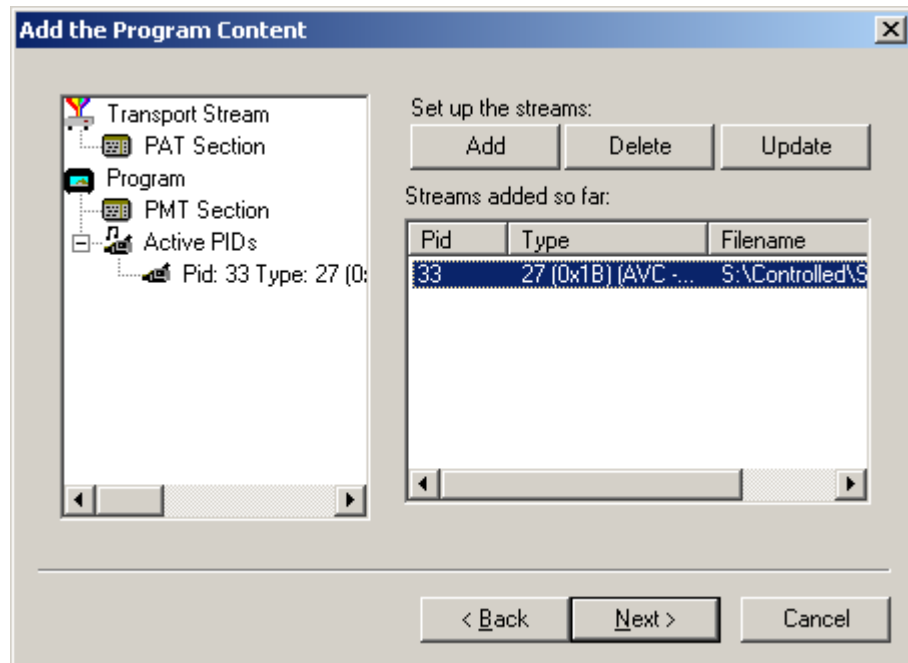

This completes the addition of one or more program streams.

17. Select Next to move to the Event Information dialog box.

For more details about the fields on these tabs, refer to *Adding an Unreferenced Elementary Stream*, page 8–99.

**Event Information Dialog Box**

The Event Information dialog box allows you to add Present and Following event information.

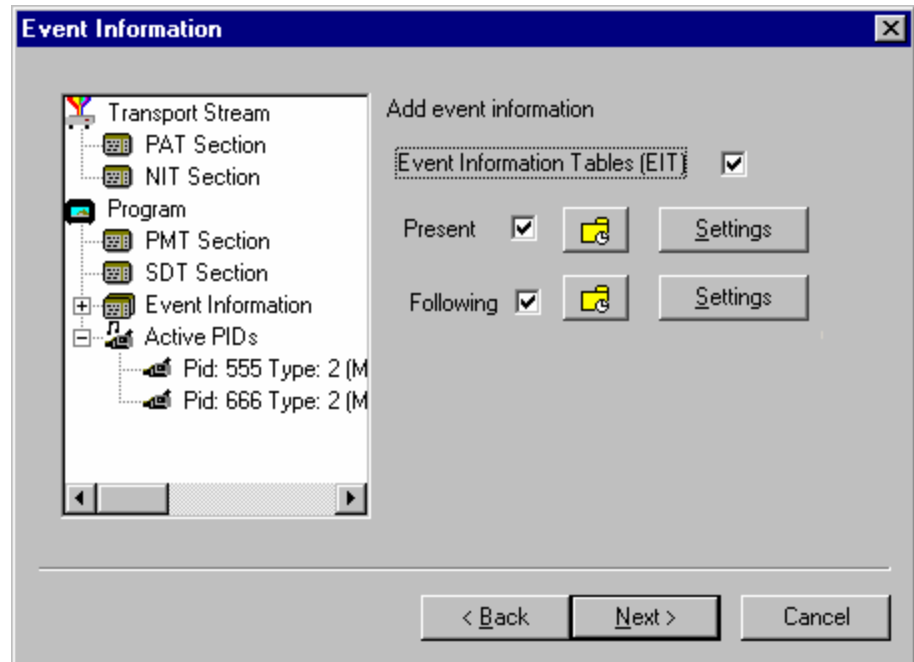

18. If the Event Information Table (EIT) is to be included in the multiplex, enable the Event Information Table check box.

19. Enable the Present and Following check boxes as required.

 Present/Following timing -

For more information on Present/Following timing see *Editing PSI/SI Table Properties*, page 8–92.

20. Use the Settings buttons to open the Present/Following Events dialog box and add and specify events as required.
21. Select Next to move to the Program Complete dialog box.

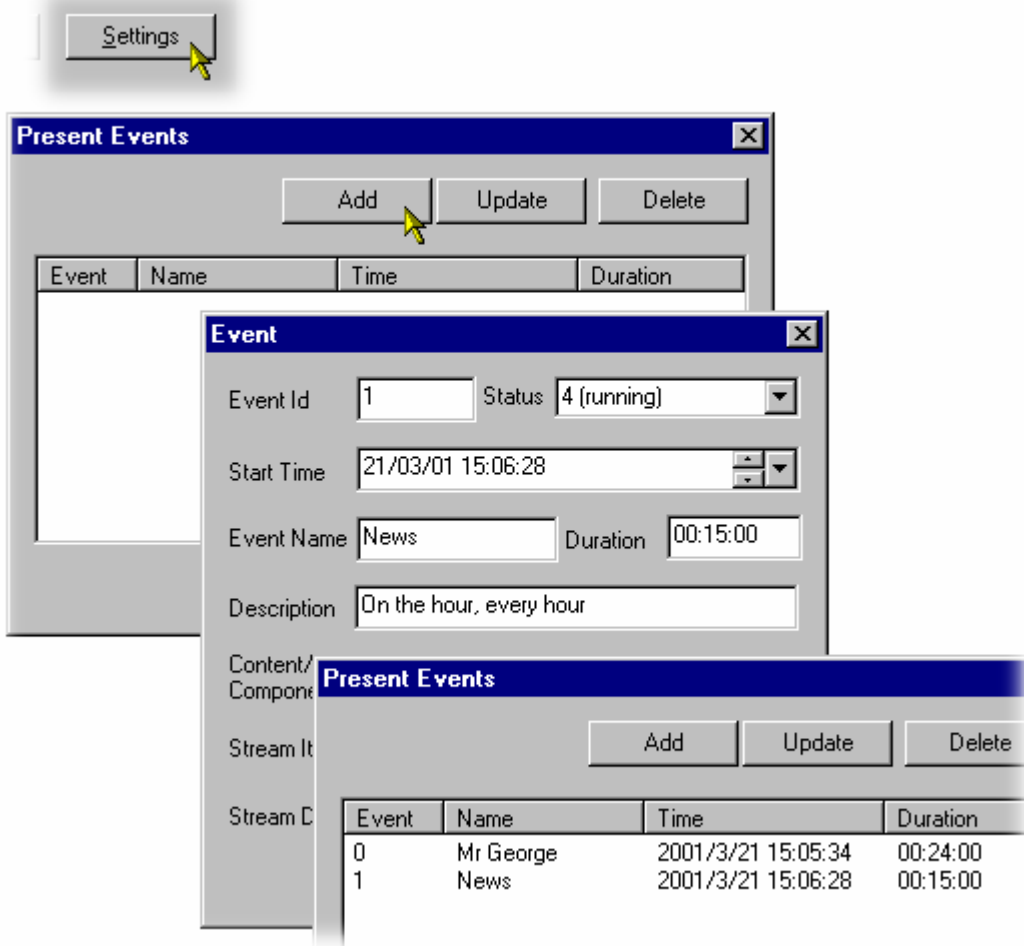

**Program Complete Dialog Box**

The Program Complete dialog box provides you with a summary of the created Transport Structure.

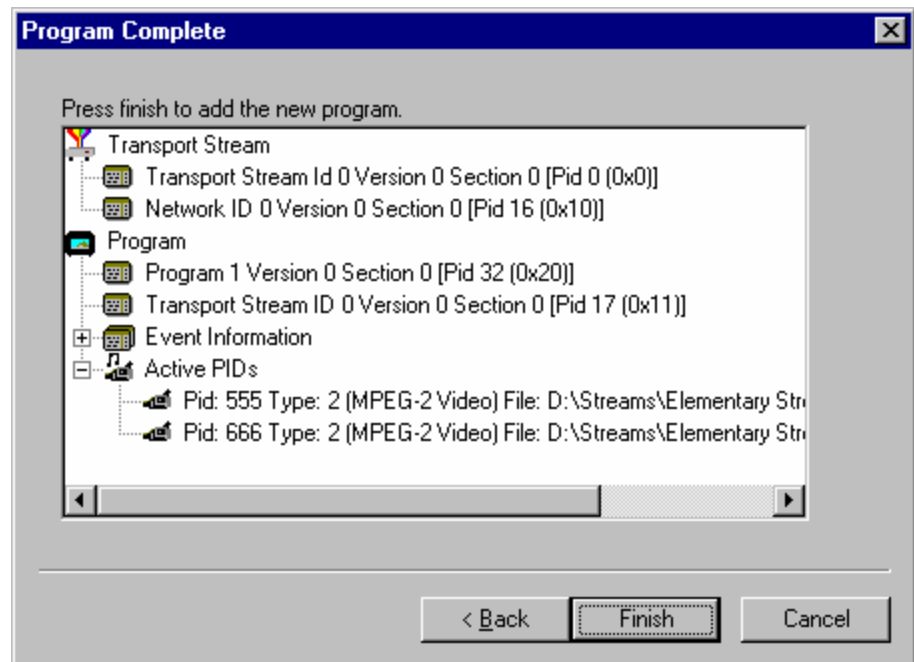

**22.** To confirm and implement the Transport Structure, select the Finish button.

Note that the proposed structure is created in the Navigator views.

This completes the procedure of adding a program to a transport stream using the Program Wizard.



# Views

Multiplexer contains a number of views, which are displayed in the working area of the user interface. All of the views can be manipulated using conventional Windows techniques. The Navigator and Error Log views can be docked against the edges of the UI or floated independently of the Multiplexer window. The Section view can be manipulated within the Multiplexer window, including tiling and cascading where multiple Section views are displayed.

Each available view displays a different aspect or level of detail of stream analysis and manipulation.

## Navigator Views

The Navigator view contains three subviews or tabs: Programs, Tables, and PIDs.

### Program Views

The Navigator Programs view extracts and displays system information that is relevant to programs. Information that is not directly related to programs (for example, NIT), or that has not been incorporated into a program (for example, elementary streams not listed in a PMT) will be omitted from the Program view. The system information is still available for viewing in the Navigator Tables and PIDs views.

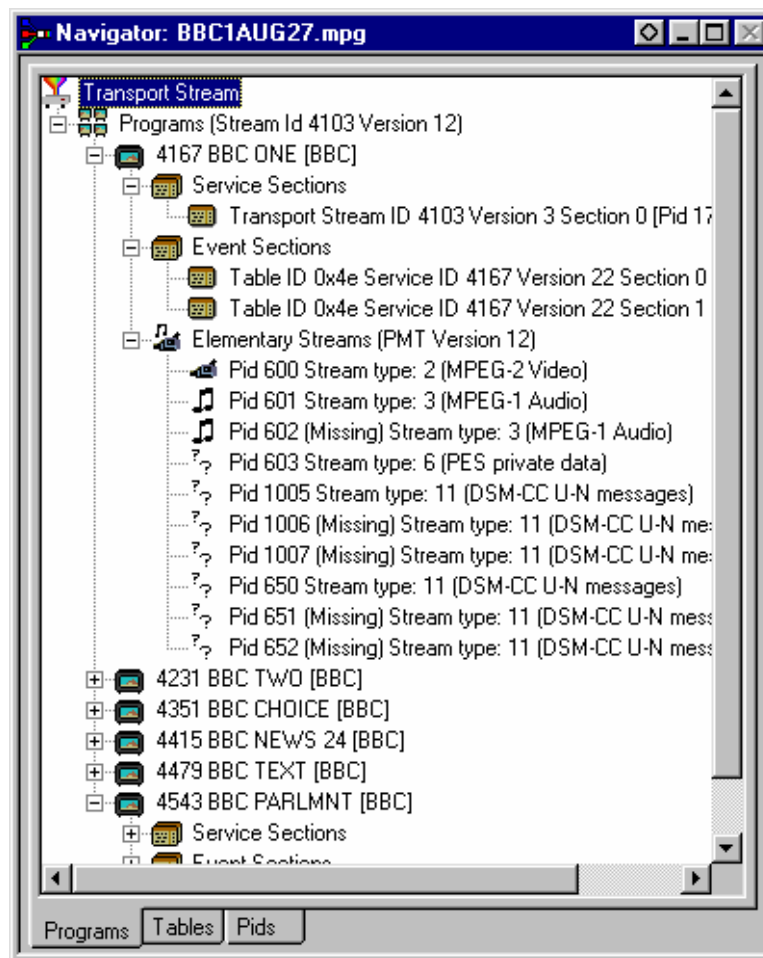

It is recommended that manipulation of programs and elementary streams should take place from the Program view.



**Tables View**

The Tables view displays high-level structure of the Program and System Information Protocol (PSIP), Service Information (SI), and Program Specific Information (PSI) tables. More detailed payload information can be examined and edited, for a selected section of a table, using the Section View.

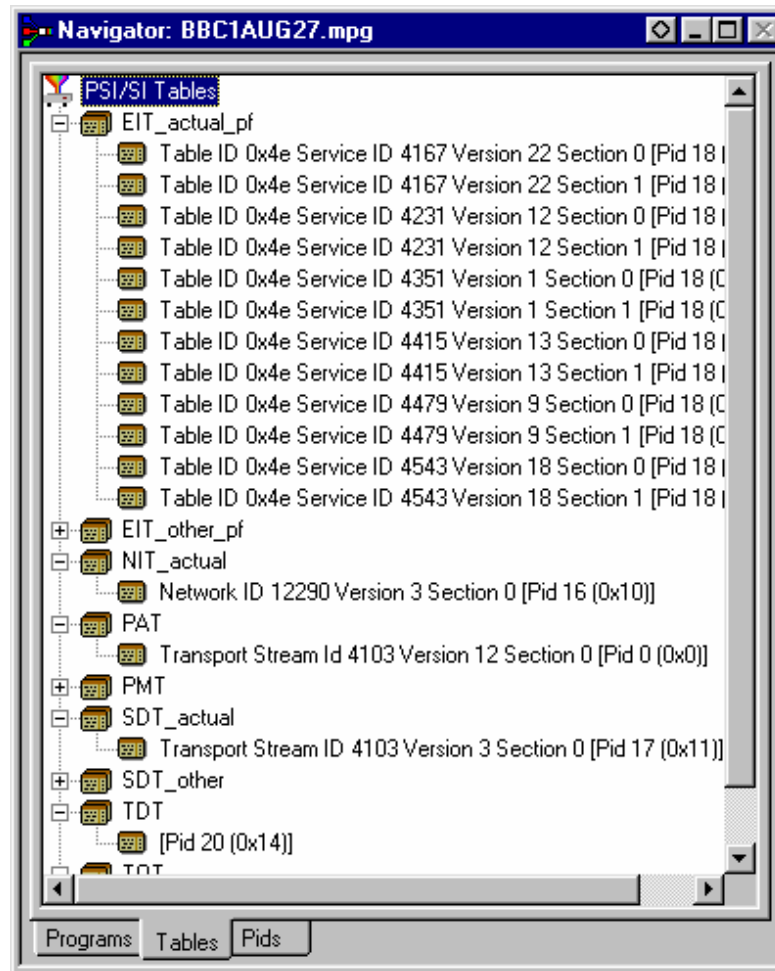

Any PSI/SI information that the program cannot confidently analyze, will be shown in the PIDs view.

**PIDs View** The PIDs view displays the PIDs contained in the stream. The PIDs are displayed in ascending numerical order.

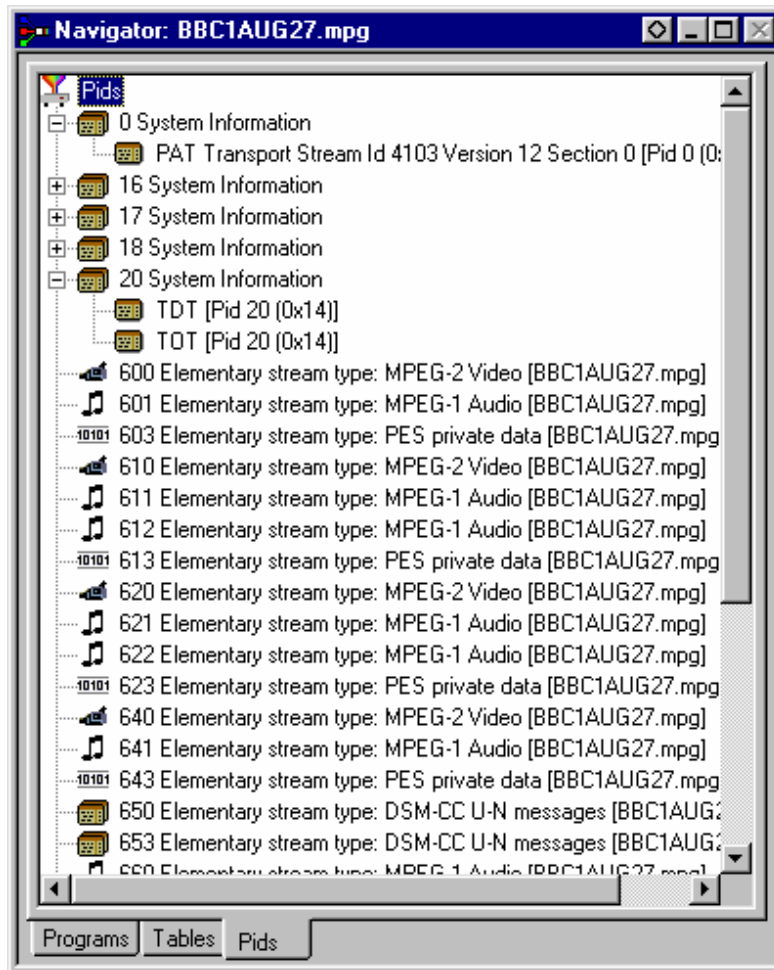

PSI/SI table types are identified in the section nodes of System Information nodes.

Elementary stream PIDs are identified by source and type where possible.

## Section View

The Section View displays the contents of the currently selected section in any of the Navigator views.

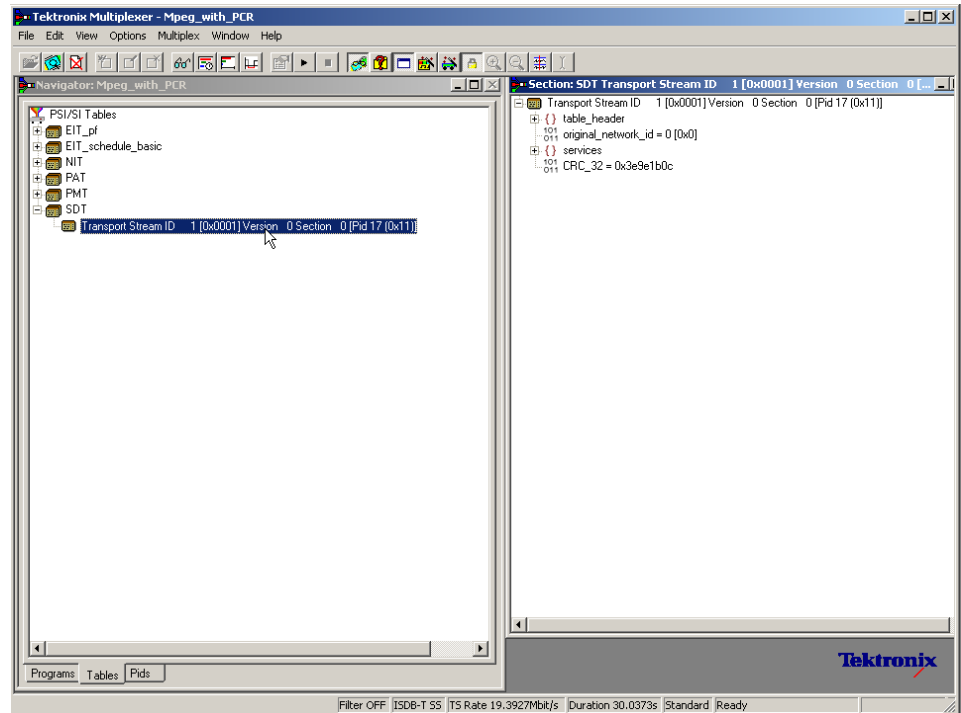

The Section view is dynamic in that it will be instantly refreshed if a new section is highlighted in the Navigator view. If no section is selected, the Section view will be blank.

The lock icon -  - adjacent to certain elements of the table in the Section view indicates that those items have restricted access due to the mode of user operation: Expert or Standard.

**Syntax of a Section** The following diagram shows a section from a Master Guide Table (MGT).

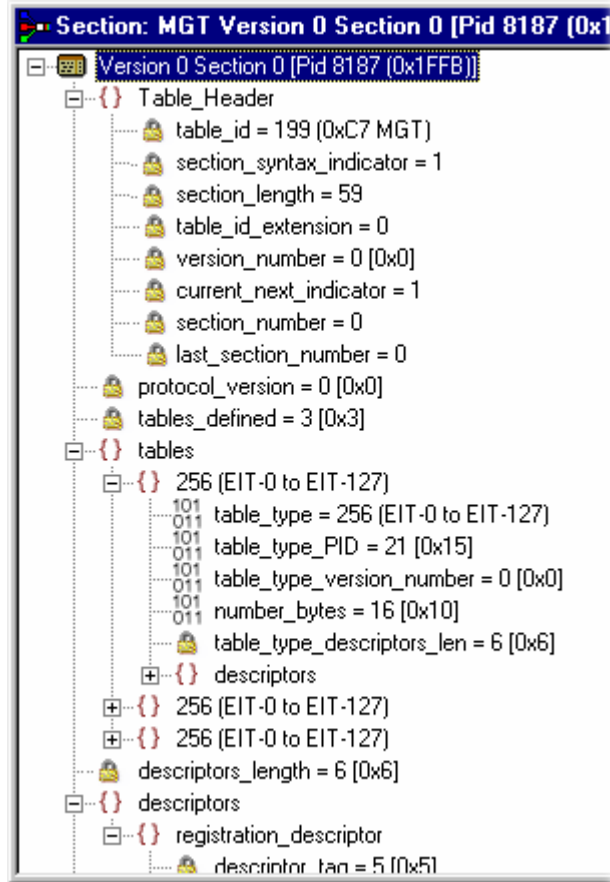

The syntax specified for an MGT in the ATSC standard A65 is:

```

master_guide_table_section () {
    table_id
    section_syntax_indicator
    private_indicator
    zero
    section_length
    table_id_extension
    reserved
    version_number
    current_next_indicator
    section_number
    last_section_number
    protocol_version
    tables_defined
    for (i=0;i<tables_defined;i++) {

```

```

    table_type
    reserved
    table_type_PID
    reserved
    table_type_version_number
    number_bytes
    reserved
    table_type_descriptors_length
    for (k=0;k<N;k++)
        descriptor()
    }
    reserved
    descriptor_tag
    descriptors_length
    for (I = 0;I< N;I++)
        descriptor()
    CRC_32
}

```

The terms used in this manual to describe the components, represented by nodes, in the structure diagram are:

Container	A term used to describe a node in the structure diagram which may contain zero, one or more loops. It is analogous to the <code>for (i=0;i&lt;loops_defined;i++)</code> statement used to describe the syntax of a table in the ATSC standards. The container is always preceded by a field which specifies the number of loops it contains.
Loop	Describes a data structure composed of a specified set of fields and subordinate loops. The structure diagram shows each loop as a node with the fields and subordinate loops as children. Each loop node in the section view represents one iteration of the loop body (the contents of the curly braces { }) in the syntax specified by the ATSC standards.
Field	Fields are referred to in the standards documents as both data items and fields. They are the smallest pieces of information that make up a table.

For example, taking an MGT that defines three tables, the Section View represents the syntax and contents of the Tables container like this:

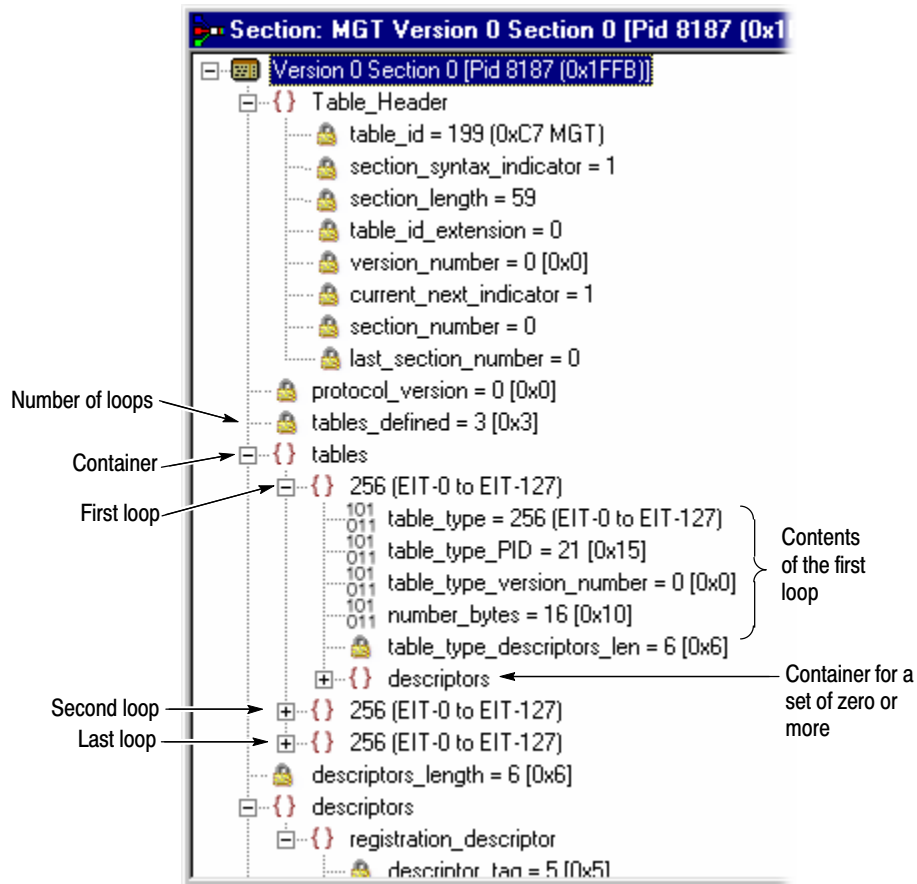

The loop for the first table, EIT-0 has been expanded to show the fields and subordinate loops that it contains.

## Syntax of a Multiple String Structure

The ATSC standard A65 defines a data structure called the Multiple String Structure. An instance of this structure may contain zero or more strings and each string may contain zero or more segments. The syntax specified for a Multiple String Structure in A65 is:

```
multiple_string_structure () {
    number_strings
    for (i= 0;i< number_strings;i++) {
        ISO_639_language_code
        number_segments
        for (j=0;j<number_segments;j++) {
            compression_type
            mode
            number_bytes
            for (k= 0;k<number_bytes;k++)
                compressed_string_byte [k]
        }
    }
}
```

Using the notation of container, loop, and field nodes, Section View represents the Multiple String Structure in the same way as any other data structure. For example: an Extended Text Table (ETT) carries its extended\_text\_message in a Multiple String Structure. The default view of a section of an ETT in the Section View looks like this:

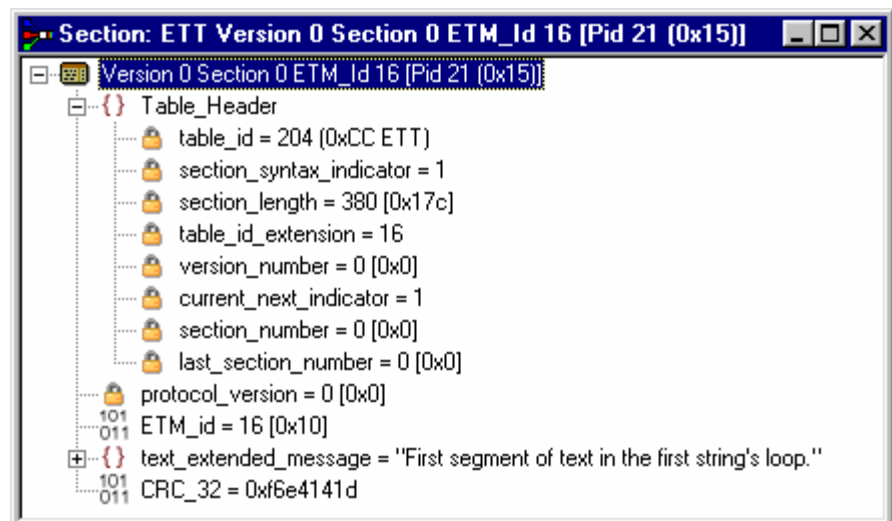

Section view displays a node for the extended\_text\_message with as much as possible of the first segment from the first string.

Expanding the node reveals a `number_strings` field which specifies the number of strings and a container which holds them (strings):

```
ETM_id = 16 [0x10]
text_extended_message = "First segment of text in the first string's loop."
  number_strings = 2
  strings
CRC_32 = 0xf6e4141d
```

The `number_strings` field shows that there are two strings in this example. Expanding the strings container shows the loop for each string. From this it can be seen that both strings are in English.

```
ETM_id = 16 [0x10]
text_extended_message = "First segment of text in the first string's loop."
  number_strings = 2
  strings
    ISO_639_LanguageCode = eng
    ISO_639_LanguageCode = eng
CRC_32 = 0xf6e4141d
```

Expanding each of the strings reveals the number of segments (`number_segments`) that make up each string and a segments container. Similarly, expanding the segments container reveals segments.



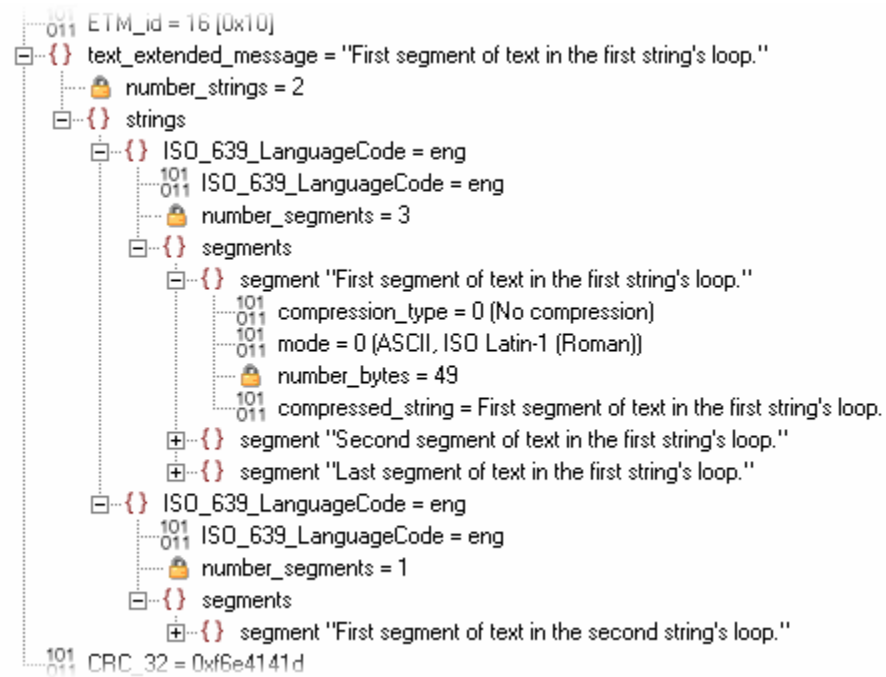

The contents of each segment loop define what compression and character set are used, followed by the actual text. The text is held in the `compressed_string` field.

**Expert and Standard Modes**

The Multiplexer has two modes of operation for conformance checking when editing table contents. These are selected from the Multiplex menu. The checks that affect the Navigator are:

**Standard Mode** Prevents changing the PID of a table whose PID number is specified in the standard, for example, PID 0x0 carries the PAT.

**Expert Mode** A warning is displayed and confirmation requested before changing the PID of a table whose PID number is specified in the standard.

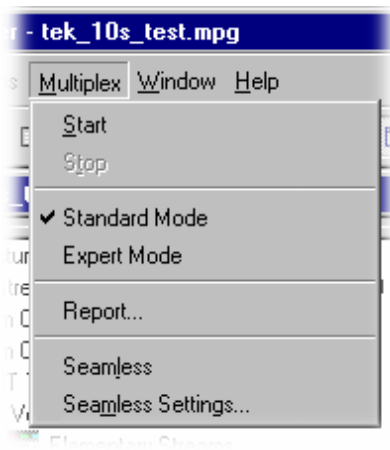

An adjacent check mark indicates the mode selected. The mode is also indicated on the Status Bar.

In the Section View a padlock symbol  is displayed adjacent to all of the fields that cannot be edited in the current mode. For example, the screens below show the same tables in Standard and Expert mode.

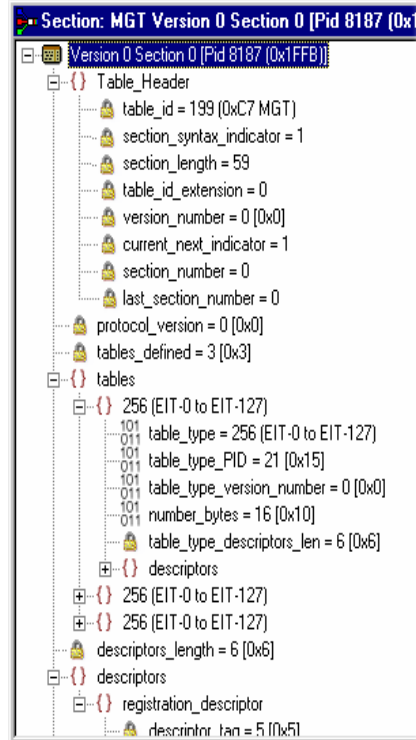

Standard Mode

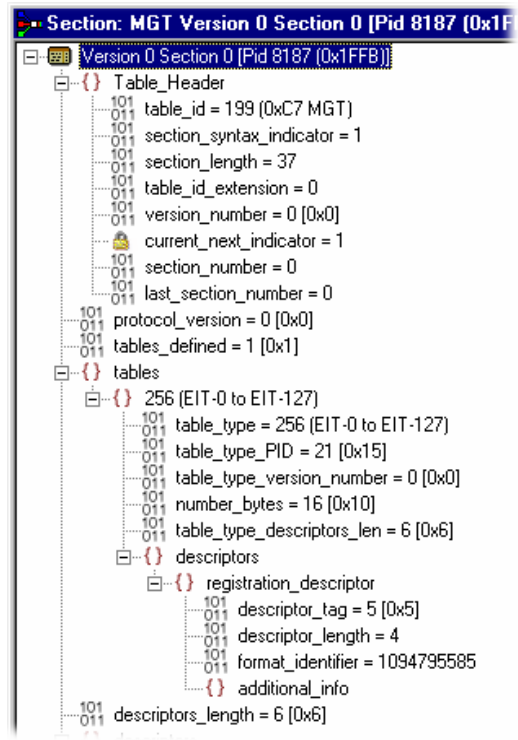

Expert Mode

**NOTE.** The *current\_next\_indicator* in both Standard and Expert mode cannot be edited. This is because the field is affected solely by the Section Properties concerned with Version Timing (see Version Timing, page 8–94).

The selected mode is also reflected in the Wizards that are used to facilitate creation of multiplexes. Elements that are restricted in the tables in Standard mode will also be restricted in the relevant wizard. Similarly, elements that are enabled in Expert mode will be enabled in the associated Wizard.

**NOTE.** The section view may need to be closed and reopened in order to update the padlock icons.

## Structure Diagram Manipulation

A tree diagram, with the “root node” or highest level component at the top represents the Transport Structure. A square box indicates components that contain more information beneath them in the structure.

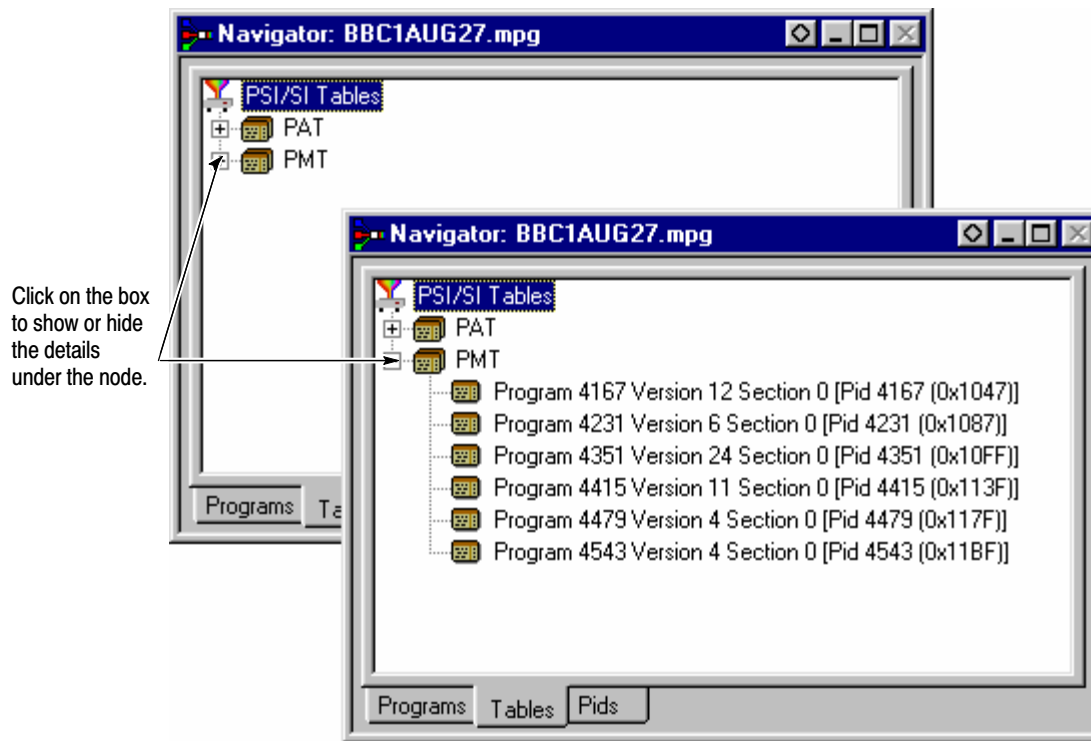

Clicking on the box does not select that node. It only shows or hides the next level of detail under that node.

If the node has a minus sign in the box the level of detail below it is currently displayed. The lower level(s) may be hidden by clicking the mouse pointer on the box.

If the box contains a plus sign, there is another level in the node that is currently hidden. Click the mouse pointer on the box to display the next level of information under the node.

Components that are connected to a branch of the tree without a square box are leaf nodes; the accompanying icon indicates the node type. They display the lowest and finest level of detail available in this diagram. These are either a Section of a Table or a PID.

Fields in the Section view that cannot be edited directly are indicated by a padlock symbol, . This protection can be switched off by selecting Expert Mode from the Multiplex menu. It can be reenabled by selecting Standard Mode.

## Event Log

Messages about significant events are written to the Event Log from the time a file is first opened. The Event Log can be opened for viewing at any time during or after the initial analysis. When the initial analysis is done, the mean transport rate, bit rate for each PEES PID, and a Demultiplex complete message are written in the Event Log.

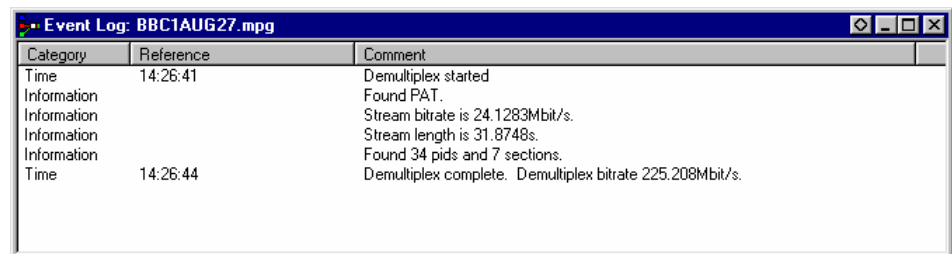

Category	Reference	Comment
Time	14:26:41	Demultiplex started
Information		Found PAT.
Information		Stream bitrate is 24,1283Mbit/s.
Information		Stream length is 31,8748s.
Information		Found 34 pids and 7 sections.
Time	14:26:44	Demultiplex complete. Demultiplex bitrate 225,208Mbit/s.

The start and end times for generating a new transport stream are shown by the Multiplexer started and Multiplexer completed messages.

Note that when demultiplexing and multiplexing streams, the bit rate at which the demultiplex or the multiplex is performed is given in the Event Log. This is in addition to the stream bit rate derived from the stream itself.

When synthesizing a new transport stream any errors or warnings about the new stream are written to the Event Log between the start and completed messages.

The Category column indicates the type of event. The subject or time of the event is shown in the Reference column and the details are given in the Comment column.

The complete text can be copied onto the Windows clipboard, using the Copy option from the shortcut menu. The text can also be cleared with the Clear command. Both commands are also available from the Edit menu.

## Examine Transport Stream Window

The Examine Transport Stream (Examine TS) window (File > Examine TS) performs two main functions within the Multiplexer:

- It allows you to take an overview of a transport stream before subjecting it to full analysis.
- It allows tables and programs to be dragged and dropped from the examined stream to the file that is currently open in Multiplexer.

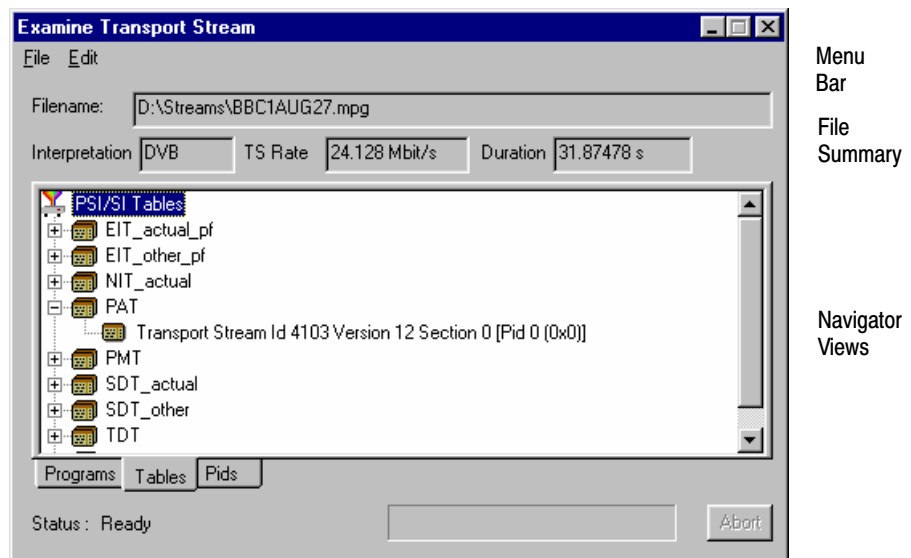

**Menu Bar** The Examine TS window menu bar contains only two items: File and Edit.

**File Menu.** Table 8–13 lists the items in the File menu.

**Table 8–13: Examine TS - File menu options**

Command	Function
Open...	Analyzes and opens the selected file in the Examine TS window. Closes the current file.
Close	Closes the Examine TS window.

**Edit Menu.** Table 8–14 lists the items in the Edit menu.

**Table 8–14: Examine TS - Edit menu options**

Command	Function
Copy	Copies the currently highlighted section to the clipboard.

**File Summary** These fields provide a brief summary of the analyzed file.

Filename	The filename of the examined stream.
Interpretation	The interpretation applied to the stream. This is the same as that selected in the Multiplexer application through the View menu: MPEG-2, DVB, ATSC, or ISDB.
TS Rate	The transport stream bit rate derived from the stream.
Duration	The duration of the transport stream.
Status	The status of the stream analysis.

**Navigator Views** The Examine TS Navigator views correspond to the Navigator views in the main application. Programs, Tables, and PIDs are shown as they would be after a full analysis. The PSI/SI tables are expanded and collapsed in the same manner. The Section view is not available in the Examine TS window.

### **Examine TS Section Copy**

While examining transport streams, it is possible to copy sections to the main multiplex using the standard Windows techniques: copy and paste or by dragging and dropping them with the aid of the mouse.

For example, to import a section that is visible in the Examine TS window into the new multiplex configuration:

1. Select the Navigator Tables view.
2. Highlight the section to be copied in the Examine TS window and do one of the following:
  - Select Edit > Copy. With the Navigator Tables view active, select Edit > Paste.
  - Using the mouse, place the cursor over the highlighted section, press and hold the left button on the mouse and drag the section onto the Navigator Tables view. Release the mouse button.
3. Note that the copied section is placed in the PSI/SI structure at the correct location. If any conflict arises concerning similar PID numbers, a new version is created.



## SI Filtering

Table elements can be excluded from the Navigator Tables view using the Display Filter available through Options > Display Filter.

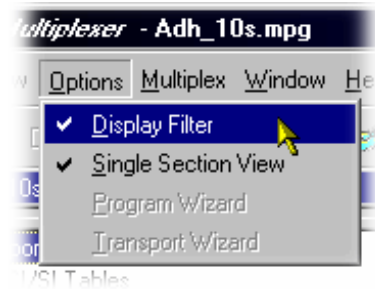

The following dialog box is displayed:

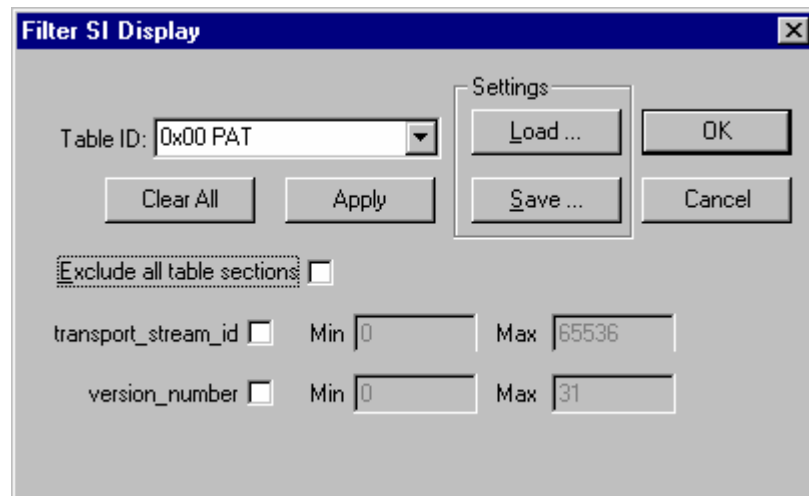

### Selecting a Table for Filtering

Example: Before filtering, the stream tree may be as shown below:

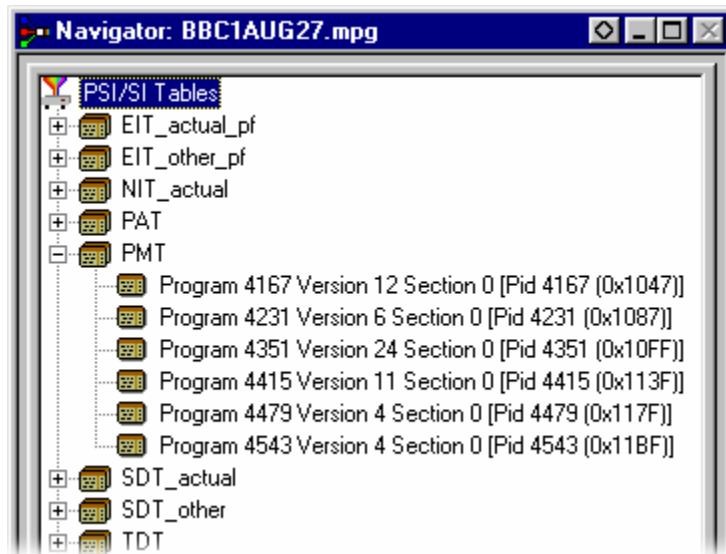

In the Filter SI Display dialog box, table identities are listed in the Table Id drop-down menu.

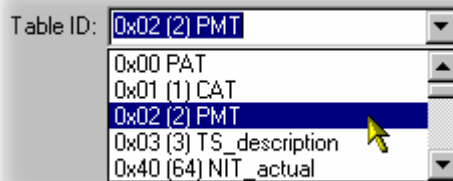

All sections of a table can be excluded by enabling the Exclude all table sections check box.

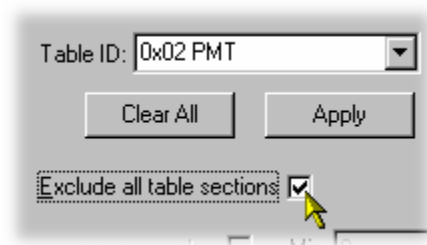

To preview the result of filtering, select the Apply button.

Note that all reference to the PMT tables is removed as shown below:

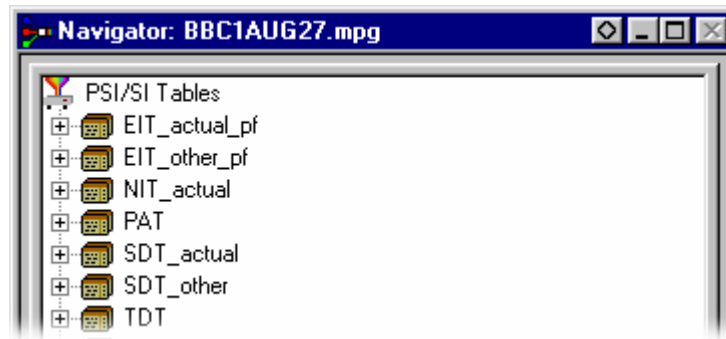

To exclude a range of sections, enable the section by selecting from the Table ID drop-down list and entering the required range.

Note that section names shown in the dialog box change according to which table is selected.

To preview the result of filtering, select the Apply button.

For example, the following settings will result in the display shown overleaf:

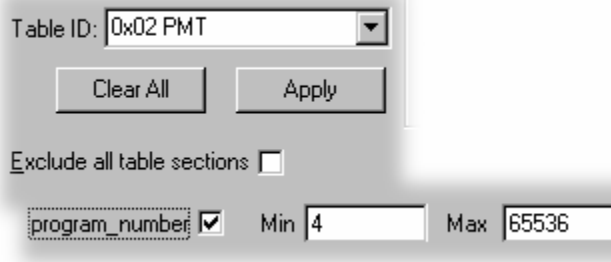

---

**NOTE.** Minimum and maximum values may be entered in either decimal (12345) or hexadecimal (0xA12B) format.

---

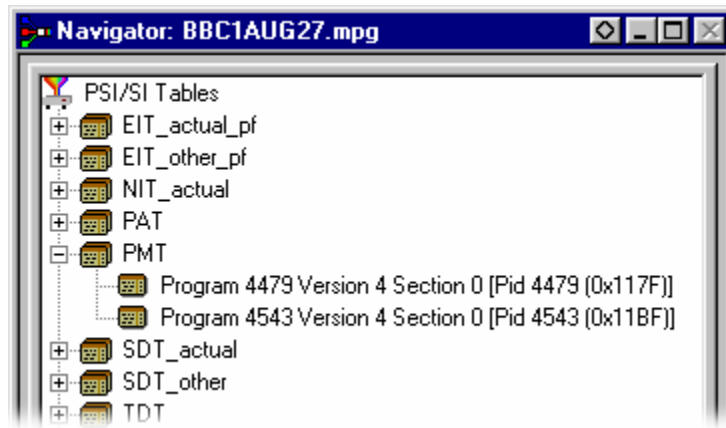

The parameters for each table must be set individually. Overall settings can be applied individually by selecting the Apply button when a setting is made or as a whole by making all of the settings and selecting the OK button.

To preview the result of filtering, select the Apply button. All settings can be cleared by selecting the Clear All button.

Note that filter settings remain in force for as long as the current multiplex is active. The settings are lost when the Multiplexer is closed unless they have been previously saved.

### **Saving/Loading SI Filter Settings**

The filter settings made in the Display Filter dialog box can be saved and subsequently reapplied to the same stream or other streams.

To save the current filter settings, select the Save button and enter a name (and location) in the Save As dialog box. To retrieve or load filter settings, select the Load button and identify the filter file in the Open dialog box. The file extension \*.fil is used.

## Component Views

The Component views provide a graphical view of the bit rate and duration of the components of a stream. The management of the views has a number of common features; these are described in the *Common Features*, page 8–77.

### Component Bit rate

The Component Bit rate view provides a graphical comparison of the stream components.

Open the Component Bit rate view either by selecting View > Component Bit rate from the Menu Bar or the toolbar button.



Each component includes the following information: Program name, PID, Description and the Bit rate in numerical and graphical form. Where appropriate, the Service ID and the Service Name is displayed (extracted from the SDT).

Program	Pid	Description	Bitrate (Mb/s)	Bitrate
<b>1</b>		<b>Tektronix I</b>		
	120	MPEG-2 Audio	0.094025	
	130	MPEG-2 Audio	0.407350	
	110	MPEG-2 Video	2.029528	■
<b>2</b>		<b>Tektronix II</b>		
	230	MPEG-2 Audio	0.094015	
	220	MPEG-2 Audio	0.156667	
	210	MPEG-2 Video	4.007894	■
<b>3</b>		<b>Tektronix III</b>		
	330	MPEG-2 Audio	0.156687	
	320	MPEG-2 Audio	0.219350	
	310	MPEG-2 Video	5.034838	■
<b>4</b>		<b>Tektronix IV</b>		
	430	MPEG-2 Audio	0.219359	
	420	MPEG-2 Audio	0.282019	
	410	MPEG-2 Video	10.066074	■
<b>5</b>		<b>Tektronix V</b>		
	530	MPEG-2 Audio	0.282012	
	520	MPEG-2 Audio	0.407360	
	510	MPEG-2 Video	15.168662	■
	8191	Null	2.786581	■

### Component Duration

The Component Duration view provides a graphical view of the timing and duration of each program/component within the current stream. Adjustments can be made to the duration of each component.

Open the Component Duration view by selecting either View > Component Duration from the Menu Bar or the toolbar button.



Program	Description	Pid	Start	Stop	Length	Bitrate (Mb/s)	Extent
1	<b>Tektronix I</b>		0.00	59.34	59.33		
	MPEG-2 Video	110	0.00	59.34	59.33	2.029528	
	MPEG-2 Audio	120	0.02	59.30	59.28	0.094025	
	MPEG-2 Audio	130	0.00	59.32	59.31	0.407350	
2	<b>Tektronix II</b>		0.00	59.84	59.84		
	MPEG-2 Video	210	0.00	59.84	59.84	4.007894	
	MPEG-2 Audio	220	0.01	59.16	59.15	0.156667	
	MPEG-2 Audio	230	0.02	59.28	59.25	0.094015	
3	<b>Tektronix III</b>		0.00	59.78	59.78		
	MPEG-2 Video	310	0.00	59.78	59.78	5.034938	
	MPEG-2 Audio	320	0.01	59.31	59.30	0.219350	
	MPEG-2 Audio	330	0.01	59.21	59.20	0.156687	
4	<b>Tektronix IV</b>		0.00	59.76	59.76		
	MPEG-2 Video	410	0.00	59.76	59.76	10.066074	
	MPEG-2 Audio	420	0.01	59.25	59.25	0.282019	
	MPEG-2 Audio	430	0.01	59.24	59.23	0.219359	
5	<b>Tektronix V</b>		0.00	59.82	59.82		
	MPEG-2 Video	510	0.00	59.82	59.82	15.168662	
	MPEG-2 Audio	520	0.00	59.31	59.30	0.407360	
	MPEG-2 Audio	530	0.01	59.29	59.27	0.282012	
	Null	8191	0.00	59.84	59.84	2.803628	

The following data is displayed for each component of the stream: Program, Description, PID, Start and Stop time (in numerical and graphical form), Length and Bit rate. The timing and bit rate elements of this information are also available in the Program Stream Properties dialog box. (See *Program Content Dialog Box*, page 8–37.)

**Scaling Bar.** The Scaling bar, which is displayed at the top of the Component Duration view, allows you to select the portion of the transport stream that is to be displayed.

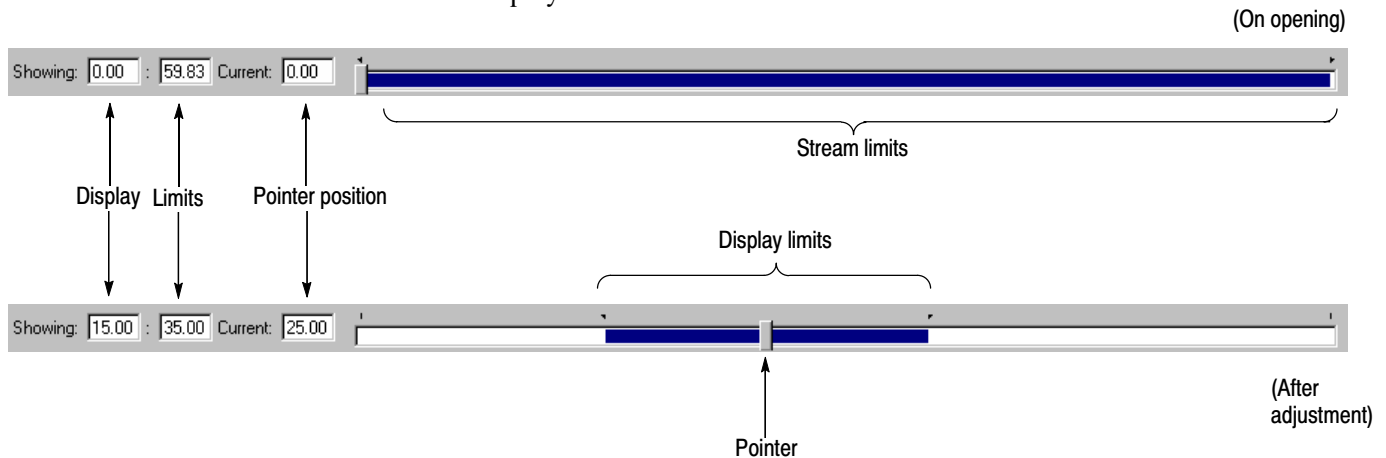

The *Stream limits* bar represents the full extent of the stream. The *Display limits* bar (dark portion) indicates the portion of the stream that is currently displayed in the body of the view.

The *Display limits* fields indicate the extents of the *Display limits* bar and the current Pointer position.

The Pointer can be dragged to a new position on the *Stream limits* bar. The *Display limits* bar will center on the Pointer.

**Duration Control.** The duration of each element in the stream is given by the Start and Stop values and shown graphically by the associated bar. The components are color coded according to which program group they belong to.

The Start, Stop and Length values can be changed by clicking on the appropriate field and entering the required value. The associated bar will reflect the change.

The Start, Stop and Length values can also be changed graphically by manipulating the bar. The cursor shape indicates the action that can be taken.

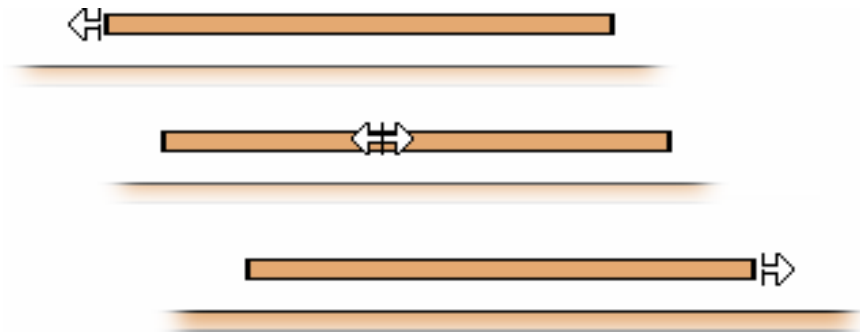

The changes are reflected in the associated field values.

Components can be changed individually. In addition, whole Program groups can be changed by manipulating the Program duration bar, but only when the view is sorted by Program.

Program	Description	Pid	Start	Stop	Length	Extent
1	<b>Tektronix I</b>		11.21	49.76	38.55	
	MPEG-2 Audio	120	14.49	38.17	23.68	
	MPEG-2 Video	110	11.21	49.76	38.55	
2	<b>Tektronix II</b>		0.00	59.84	59.84	

Program duration

A vertical dotted line indicates the upper limit of the multiplexed stream.



In the Transport Stream Properties dialog box (View > Properties with the Transport Stream node highlighted in the Navigator Programs view), you can determine how and if the stream duration is updated. The available options will be:

- Select Fixed to ensure that the stream duration can only be updated in the Stream Properties dialog box.
- Select Set to the greatest component stop time to ensure that the stream duration is set to the greatest stop time recorded in the SI/PSI/PSIP tables.

Component start and stop times changed in the Component Duration view are automatically updated in the SI/PSI tables.

**Available Bit rate**

The Available Bit rate view displays in graphical form the available bit rate for the duration of the multiplex.

The bit rate is calculated using the MGB2 measure (Ref: ETSI TR 101 290). Open the Available Bit rate view by selecting View > Available Bit rate from the Menu Bar or by using the toolbar button.

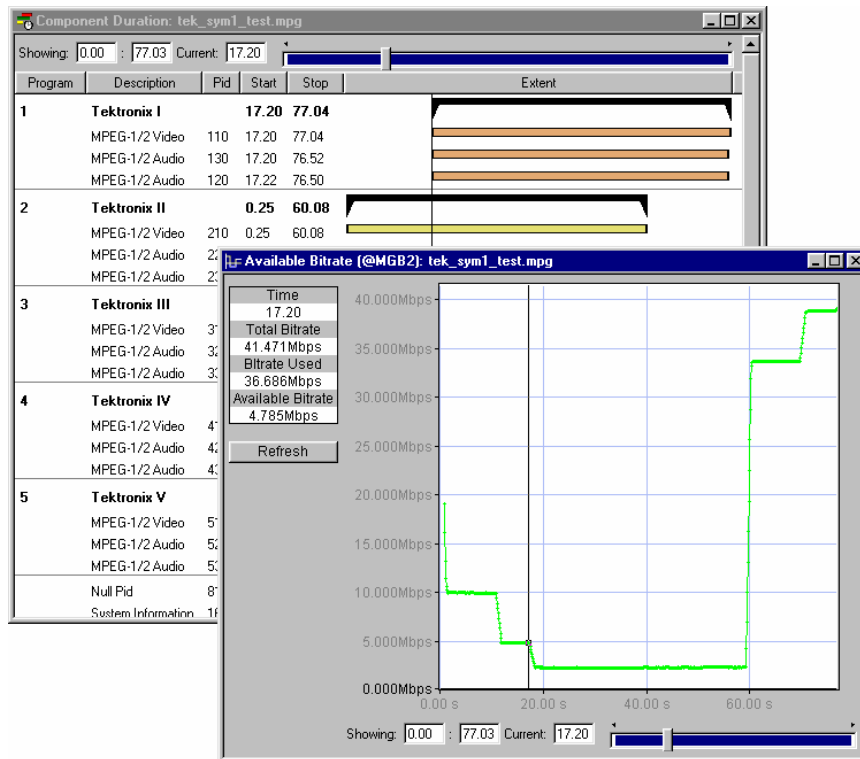

If the bit rate falls below zero, the points will be highlighted in red. When editing a multiplex, you can add components which cause the bit rate to fall below zero and no warnings will be displayed. However, if a transport stream is then generated, errors will be logged and displayed in the Log view.

Use Refresh to redraw the graph. Clicking anywhere within the graph will place a vertical cursor at that point; the position and bit rate are displayed in the Time and Available Bit rate fields.

The zoom level and cursor placement of the Available Bit rate and the Component Duration views can be synchronized by selecting View > Synchronize.

**Common Features**

Columns in the Component views can be sorted and rearranged to suit your preferences. Column management in the two Component views is similar.

**Field Selection.** You can select the fields to be displayed in each Component view. The Header bar indicates which fields are currently displayed.

When you right-click on the Header bar, a menu is displayed. You can select which fields are to be displayed. A check mark next to a field name indicates that the field display is currently enabled.

The version number of the PAT and PMT can be displayed in the Description column by enabling the Show program version option in the shortcut menu from the Description column header.

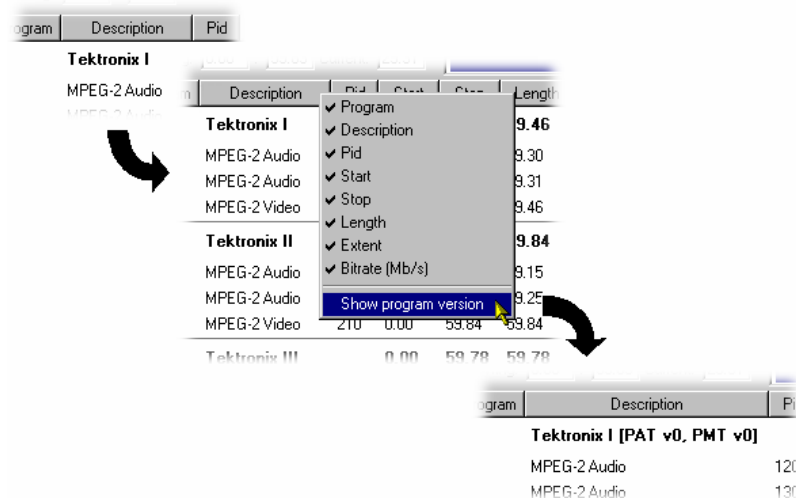

Similarly, the PID numbers can be displayed in hexadecimal, by selecting Display in hexadecimal from the PID column shortcut menu.

**Column Repositioning.** Columns can be repositioned as required. Click and drag the column to the required position.

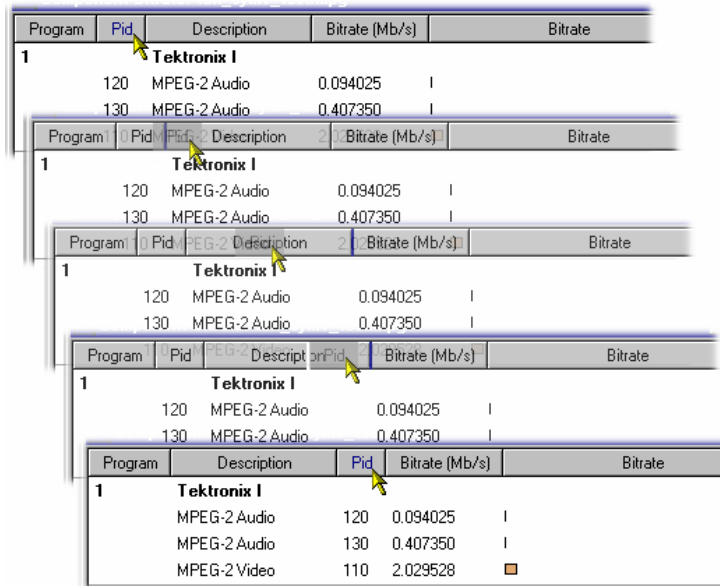

**Column Width.** Columns can be resized as required. Place the cursor over the dividing line between two columns; it will change to the resizing cursor. Click and drag the column to the required width. The change will be made to the column to the left of the cursor.

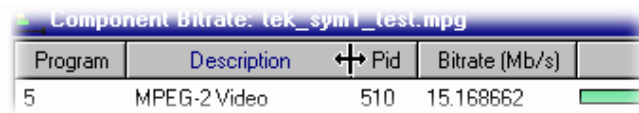

Double-clicking the column divider will automatically resize the column to the left to the optimum size required to view the content.

**Column Sort.** Columns can be sorted in ascending or descending order. Click the cursor on the heading to sort the column. Clicking again will sort the column in reverse order.

The image shows two screenshots of a multiplexer interface. The top screenshot shows a table with columns: Program, Description, Pid, Bitrate (Mb/s), and Bitrate. The table is sorted by Description. The bottom screenshot shows the same table sorted by Program, with a mouse cursor hovering over the Description column header.

Program	Description	Pid	Bitrate (Mb/s)	Bitrate
1	MPEG-2 Audio	120	0.094025	I
1	MPEG-2 Audio	130	0.407350	I
2	MPEG-2 Audio	230	0.094015	I
2	MPEG-2 Audio	220	0.156667	I
3	MPEG-2 Audio	220	0.156667	I
2	MPEG-2 Audio	230	0.094015	I

Program	Description	Pid	Bitrate (Mb/s)	Bitrate
	Null	8191	2.786581	
1	MPEG-2 Video	110	2.029528	
2	MPEG-2 Video	210	4.007894	
3	MPEG-2 Video	310	5.034838	
4	MPEG-2 Video	410	10.066074	
5	MPEG-2 Video	510	15.168662	
2	MPEG-2 Audio	230	0.094015	I

Similarly, the columns can be grouped in Program order, by clicking the Program header.

## Common Menu Options

The specifications for components of the various views can be manipulated by options from the Edit menu, View Menu, and Toolbar.

There is also a shortcut menu that provides the Add, Modify, Delete, Import, Export and Properties options. Place the mouse pointer over the component to change and click the right mouse button to open the menu.

A typical shortcut menu is shown here:

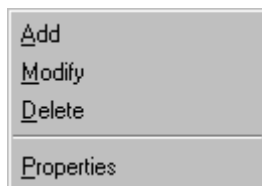

The menu options are context-sensitive and will be enabled or disabled according to the current selection in the view.

The following options are available from the various shortcut menus:

Add	Adds a component to the currently selected item.
Modify	Opens the properties dialog box.
Delete	Deletes the currently selected component.
Properties	Opens a properties dialog box for editing the currently selected item.
Export Payload	Extracts and exports the payload of the source transport stream in the form of a simple data file.
Export Elementary Stream	Removes the transport stream and PES headers and exports the remaining information in the form of a simple data file.
Export Section Data	Extracts and exports section data. The created file can be imported as ES using Multiplexer's Add function or as SI using the Import Section Data... option.
Import Section Data	Imports SI data form a file and analyzes it. The section is added to the Navigator view.



## Editing in the Navigator Views

Multiplexer provides a variety of ways of building and modifying transport streams for multiplexing. In addition to the Menu Bar options and Toolbar shortcuts built into the Multiplexer, many of the operations can be carried out using familiar drag and drop Windows techniques.

In the following descriptions, the alternative methods for carrying out a task are given at the head of the section, but only one method is described for each action. Other methods for the same action often invoke the same dialog boxes and sequence of follow-on actions.

### Dragging and Dropping

To drag a file, click on its name and hold down the left button of the mouse while dragging the file to the required location. The cursor will change according to the background that it is dragged over:

	(With Ctrl key held) when dropped, the file will be copied.
	When dropped, the file will be moved (cut and pasted).
	When dropped, no action will be taken.

Note that as the file is dragged over elements in the Navigator, receptive elements (elements where the file can be meaningfully dropped) will be highlighted.

## Transport Stream

**Opening an MPEG File** For information on *Opening a Stream*, refer to page 8–11.

**Opening a Multiplexer File** For information on *Opening a Stream*, refer to page 8–11.

**Changing Transport Stream Bit rate and Duration** To specify a new bit rate or duration for the transport stream, select and highlight the Transport Structure component in the Navigator view.

From the shortcut menu, select Properties. The dialog box shown below will be displayed.

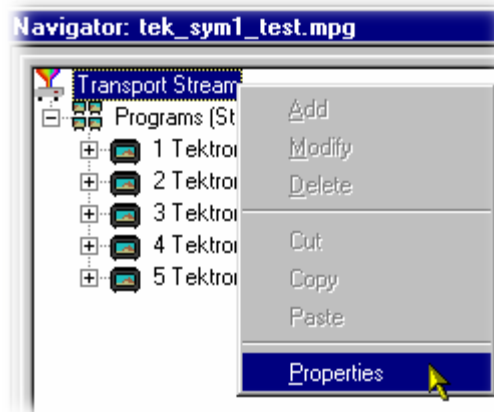

Edit the Bit rate and the Duration as required, then click on the OK button.

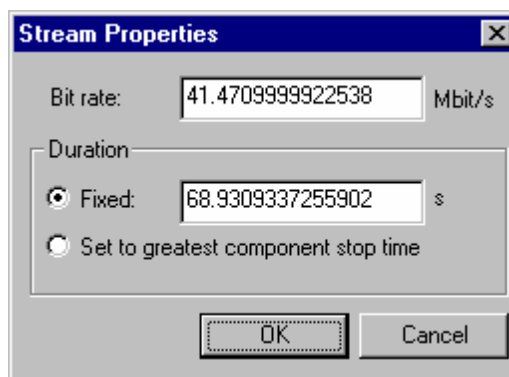



## Programs

The introduction of the Navigator Programs view has provided a more program-centered means of manipulating SI/PSI. Whole programs can be added to the multiplex and the application will update the associated tables, including the PAT and PMT.

Note that the nodes of the tree structure in the Navigator Programs view are context sensitive. When dragging and dropping files from either the Examine TS window or from another instance of Multiplexer, a node will only be highlighted as the cursor passes over it when the operation proposed is legal. Note that there may be a short delay before the node is highlighted while the legality of the operation is checked.

### Adding a New Program

With the Transport Stream ID field highlighted in the Navigator Programs view, selecting the Add option either from the shortcut menu (PAT highlighted in Navigator Programs view) or the Menu Bar (Edit > Add) will open the Program Wizard (see page 8–35).

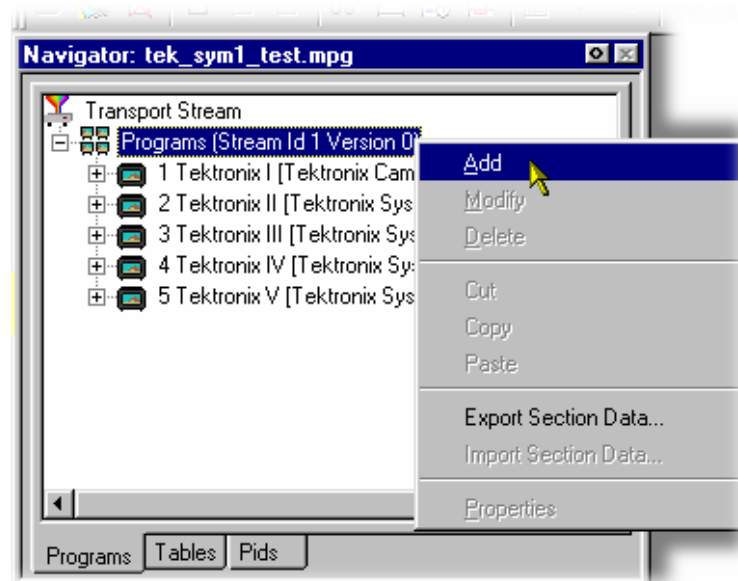

In the Navigator Programs view, the PAT is represented by the Transport Stream ID field.

### **Copying/Moving a Program**

Methods available:

- Drag and drop (copy only) from the Examine TS window (Programs view) to the Navigator Programs view.
- Drag and drop (copy/move) from another instance of Multiplexer to the Navigator Programs view.

In the Navigator Programs view, programs can only be dropped onto the PAT node.

## Tables

### Adding a New PSI/SI Table

Methods available:

- Highlight the PSI/SI Tables level in the Navigator Tables view and select Add from the shortcut menu.
- Drag and drop (copy only) from the Examine TS window (Tables view) to the Navigator Tables view.
- Drag and drop (copy/move) from another instance of Multiplexer to the Navigator Tables view.

Any Table that is defined in the selected standards, and not already present, can be added the transport stream. To add a table to the transport stream, click on PSI/SI Tables in the Navigator Tables view:

1. Highlight the PSI/SI Tables level and select Add from the shortcut menu.

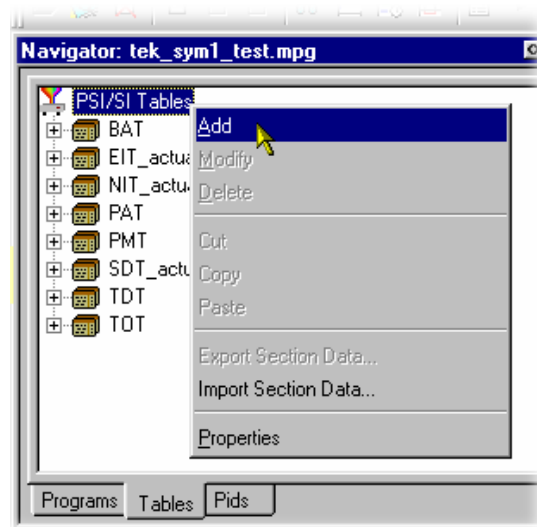

This will open the Select dialog box. The dialog box displays a list of the table types that are not already present in the stream.

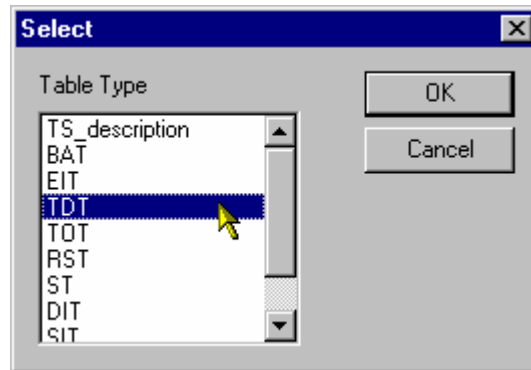

---

**NOTE.** A PAT table cannot be added when ISDB interpretation with Single segment extension is selected.

---

2. Highlight the required table type and then select the OK button.

Pressing Cancel will abandon the operation without adding a new table.

Only the table types that are not currently specified for the stream are listed. If the required table type is not listed, press the Cancel button to close the dialog box without affecting the specification for the stream.

The Select PID & Table ID dialog box is displayed only if a PID and/or Table ID need to be identified. Otherwise, the selected Table type is automatically created.

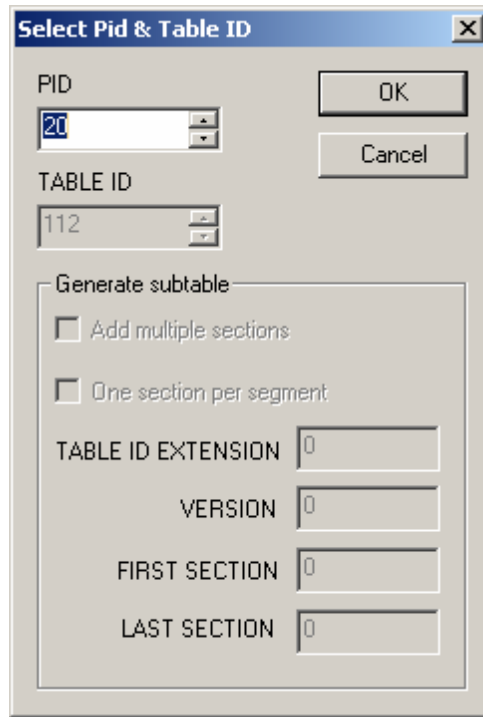

A single section is automatically added to the newly created table type.

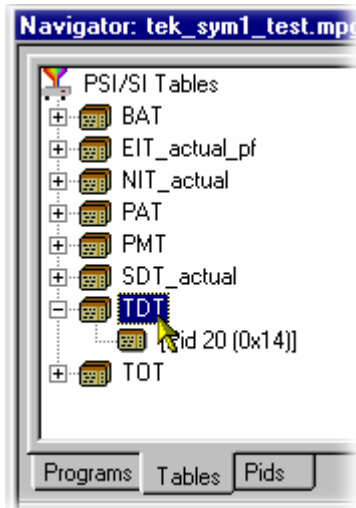

**Copying a PSI/SI Table**

Methods available:

- Drag and drop (copy only) from the Examine TS window (Tables view) to the Navigator Tables view.
- Drag and drop (copy/move) from another instance of Multiplexer to the Navigator Tables view.

Tables can be copied (or moved) from existing multiplexes, using either of the available methods.

If a similar table type is already present in the multiplex, the contents of the copied table will be integrated with it.

**Deleting a PSI/SI Table**

A table is automatically removed when the last section is deleted (see page 8–96).

**Exporting a Table**

For more information on *Exporting a Section*, refer to page 8–97.

**Importing a Table**

For more information on *Importing a Section*, refer to page 8–98.

## Sections

### Adding a New Section to a PSI/SI Table

Methods available:

- Highlight the parent table level in the Navigator Tables view and select Add from the shortcut menu.
- Drag and drop (copy only) from the Examine TS window (Tables view) to the Navigator Tables view.
- Drag and drop (copy/move) from another instance of Multiplexer to the Navigator Tables view.

To add a section to a table, select the parent table in the Navigator Tables view. For example, to add a section to the SDT, select SDT Tables:



Then select Add from the shortcut menu.

The Select PID & Table ID dialog box is displayed only if a PID and/or Table ID need to be identified. Otherwise the selected section is automatically created.

Select the required PID and Table ID (where enabled) and press OK.

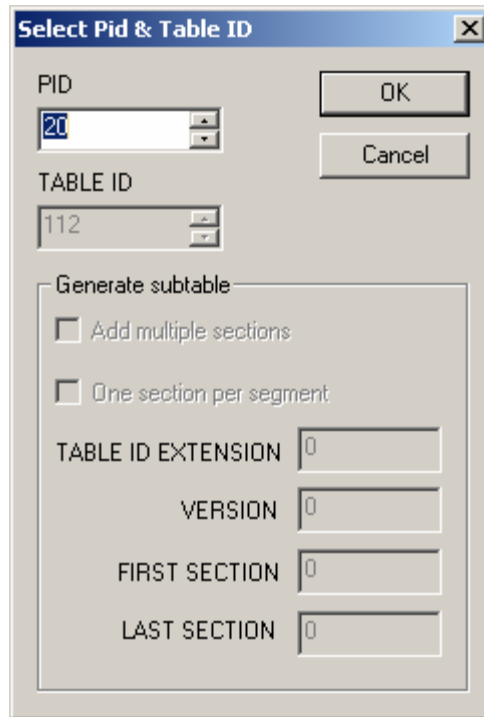

Pressing Cancel will abandon the Add operation without adding a new section.

The version/section of a table is created with a new version or section number. The rules used by Multiplexer for numbering are:

- For tables that the selected standard dictates should always have a section number of 0, the version number is increased by one. The new version number is based on the version currently in the table with the most recent number. The version\_number is a 5-bit field, so if the new version would be 32, it is reset to 0.

$$\text{version\_numberNEW} = (\text{version\_numberRECENT} + 1) \text{ modulo } 32$$

- For any table type that allows a section\_syntax\_indicator, the Add multiple sections check box in the Generate subtable part of the dialog box is enabled. Additionally, the One section per segment check box will only be enabled for the EIT schedule table type.



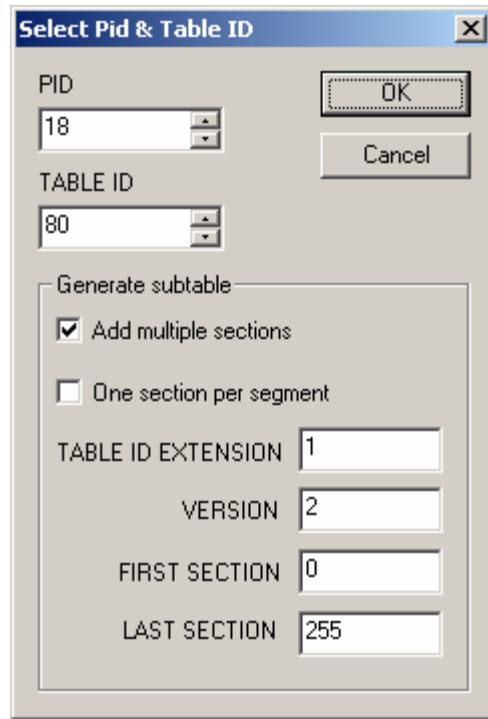

- Up to 256 sections can be added.
- Additions to existing subtables using the same Table Id Extensions and Versions will be rejected.
- When multiple EIT Schedule sections are being added, the One section per segment check box is enabled. When it is checked, only the first section in each segment will be created, rather than all sections numbered between First section and Last section.

When dragging and dropping a section, the Multiplexer will resolve any numbering conflicts by creating new versions of duplicated tables.

### Editing PSI/SI Table Properties

Table and Section Properties are edited by selecting and highlighting one of the versions/sections within the transport structure and selecting the Properties option from the shortcut menu.

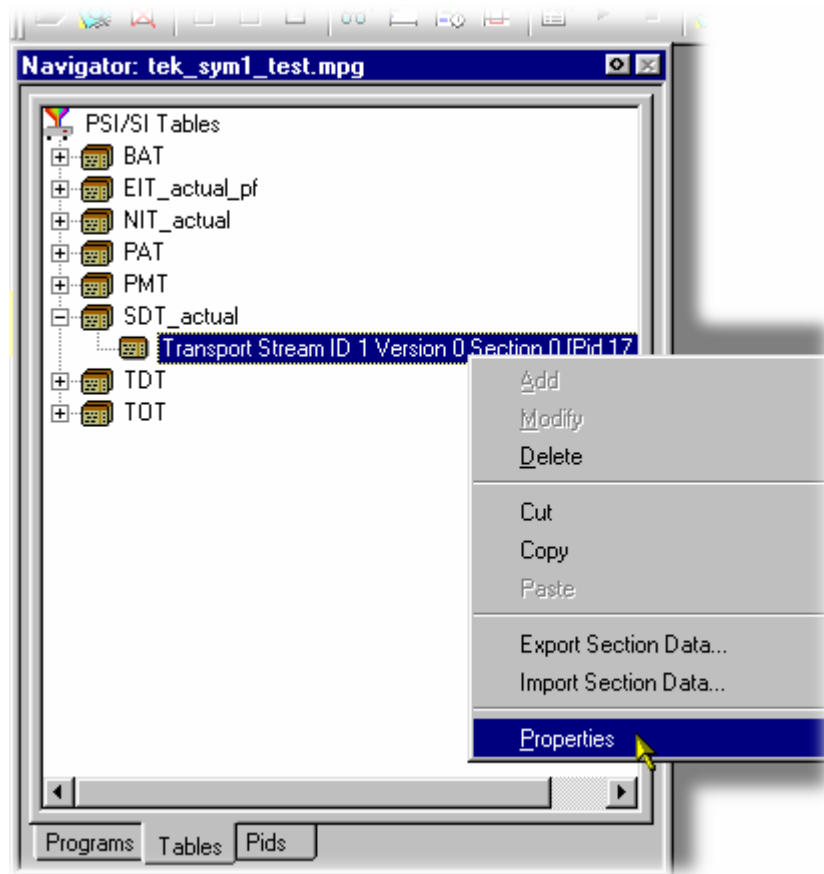

This opens a dialog box with four tabs, one for each property. Depending on the type of table, properties can be applied to a specific version or section of the table. Multiplexer allows only operations that make sense in the context of the selected table type.

The properties that can be edited from the Navigator Tables view are:

**PID Number.** The PID tab is displayed by default when the Section Properties dialog box is opened.

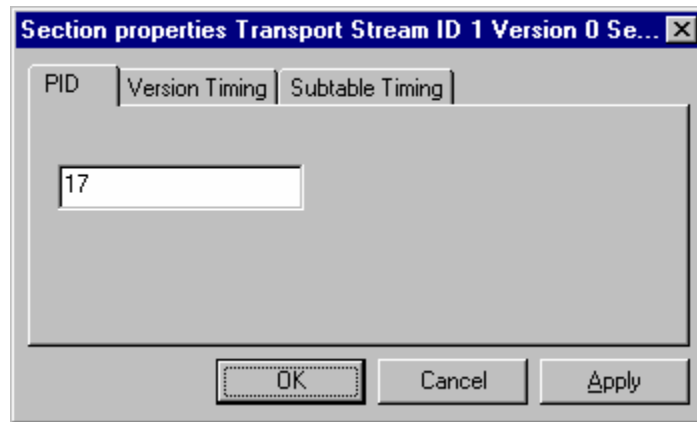

Edit the value and select OK to change the PID number.

Edit the value and select Apply to make the changes and update the other properties (tabs) without having to close this dialog box.

Multiplexer checks the new PID number against the selected standards and warns of any nonconformance issues. If a conflict is found, a warning message is displayed, with the option to continue. Multiplexer also checks for conflicts with other PIDs. If the new PID number conflicts with an existing PID, an error message is displayed and the change is rejected; in this case, either choose a different PID number for the table or edit the number of the PID that is currently the owner.

If no conflict is found, another dialog box is opened to define the scope of the changes:

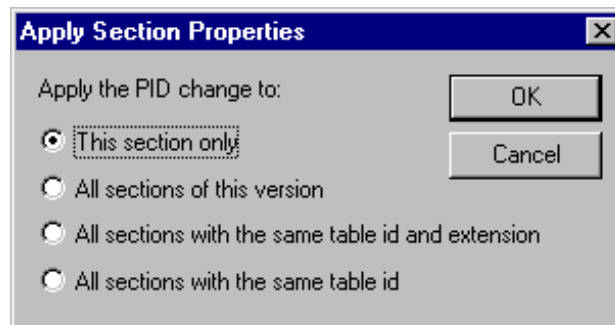

Select the required scope and click OK. Selecting Cancel will abandon the change.

**Version Timing.** The Version timing tab shows the time when the version will become current, and the start and end times. New values may be specified for any of these times.

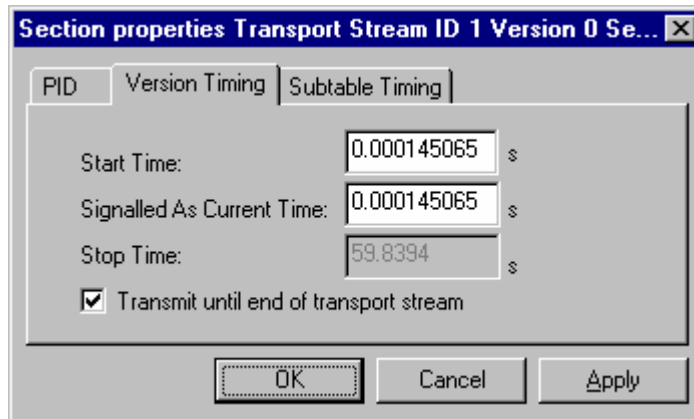

Start Time	Specifies the time at which sections of this version will start to appear in the transport stream.
Signalled As Current Time	Controls the time when the sections with this version will have the <code>current_next_field</code> set to 1.  By default when these sections start to appear in the transport stream, the <code>current_next_field</code> of the section set to 0. To specify a version that is always current set the Start Time and Signalled As Current Time fields to the same value.
Transmit until end of transport stream	Enables the section to be repeated until the end of the transport stream. If the check box is disabled, the Stop Time becomes active.
Stop Time	Specifies the time after which no sections of this version will appear in the transport stream.

All of the times are in seconds, taken from the start of the transport stream file. The default start time for PAT is 0.00 s and for PMT is 0.001 s.

Edit the values and select OK to change the timings. Edit the values and select Apply to make the changes and update the other properties (tabs) without having to close this dialog box.

**Subtable Timing.** Service information is usually constrained to appear at regular intervals in the transport stream. This is usually implemented as a maximum time between appearances of all the sections of a subtable (where a table is defined by the table\_id, table\_id\_extension and version\_number on the same PID).

Use the Subtable Timing tab to specify the desired and the maximum acceptable period between instances of the subtable. When an MPEG file has been opened, this shows the mean time between instances of the subtable in the transport stream.

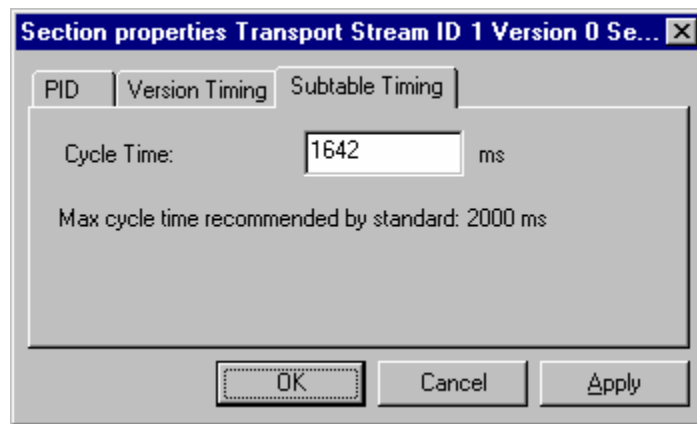

**Cycle Time** Displays the mean time between instances of the subtable specified for synthesizing a new MPEG file. The value can be edited to specify a different cycle time.

Beneath the Cycle Time, the dialog box displays subtable specific information from the currently selected standard.

Edit the values and select OK to change the Cycle Times. Select Apply to make the changes and update the other properties (tabs) without having to close this dialog box.

When synthesizing a new transport stream, the multiplex engine tries to insert the subtable at the frequency specified by the Cycle Time. An error message is written to the event log whenever a subtable cannot be multiplexed into the stream within the period specified by the maximum cycle time.

**Section Timing.** Where a table can contain only a single section (for example, TOT and TDT), a section timing tab is displayed in the Properties dialog box.

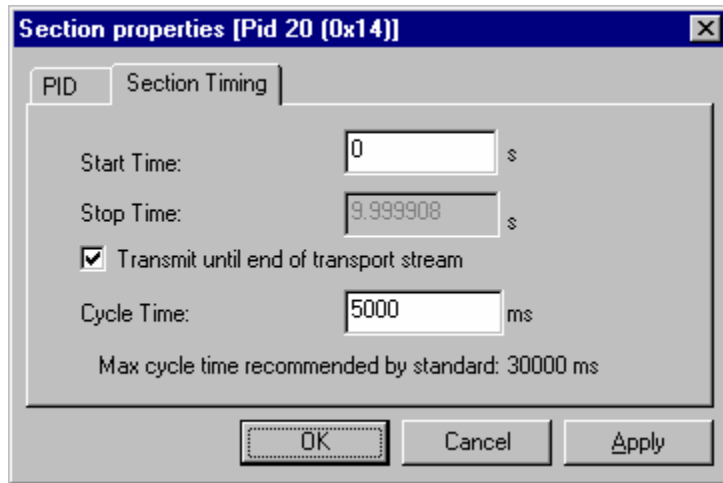

Start Time	Specifies the time at which the first appearance of this section will occur.
Stop Time	When enabled, specifies the time at which the last appearance of this section will occur.
Transmit until end...	When enabled, specifies that the section should be transmitted until the end of the stream.
Cycle Time	Specifies the interval at which the section should be transmitted.
Max cycle time...	Gives the cycle time recommended by the current standard.

Edit the values and select OK to change the timings. Select Apply to make the changes and update the other properties (tabs) without having to close this dialog box.

An error message is written to the event log when a table cannot be multiplexed in accordance with the timings set.

### Deleting a Section

A section can be deleted from a table by highlighting it in the Navigator Tables view and selecting Delete from the shortcut menu. To delete more than one section, select and delete each one in turn. When the last section is deleted from a table, the table is automatically deleted from the structure.

## Exporting a Section

Section data can be exported in the form of a binary file. In the Navigator Tables view, highlighting a Table node (for example, PMT Tables), allows all sections of the table to be exported. Similarly, highlighting a single section entry (for example, Program 123) allows only that section to be exported.

Highlight the required section or Table node in the Navigator Tables view. From the shortcut menu, select Export Section Data. Name the file to be created and choose a location. Select Save to confirm the action.

Individual sections can also be exported using the Navigator Programs view. Highlight the required section to be exported. From the shortcut menu, select Export Section Data. Name the file to be created and choose a location. Select Save to confirm the action. Note that not all tables are shown in the Navigator Programs view, for example, TOT.

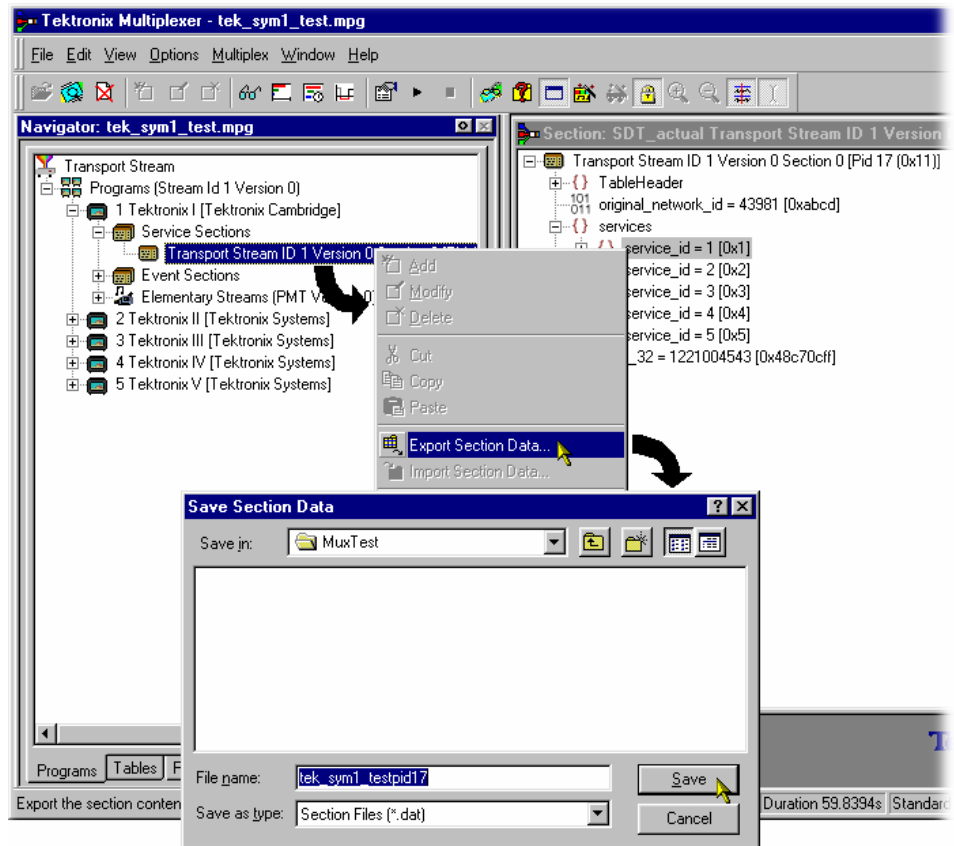

### **Importing a Section**

In the Navigator Tables view, highlight the PSI/SI Table node. From the shortcut menu, select Import Section Data. In the PID tab of the Import Section Data dialog box, identify the PID that is to carry the information. Similarly, in the Source tab, identify the file that holds the section data to be imported. Select OK to confirm the selection. During the import action, the content of the file is examined to determine where the section(s) should be placed.

## **ES PIDs**

ES PIDs that carry additional Elementary Streams can be multiplexed into the synthesized transport stream. The following actions are required when defining an elementary stream to be added:

- Allocate a PID number
- Define the source of the elementary stream to be added
- Define the timing to be applied to the new stream
- Define the PCR placement



### Adding an Unreferenced Elementary Stream

#### Methods available:

- Highlight the ES PIDs in the Navigator Tables view and select Add from the shortcut menu.
- Drag and drop (copy only) from the Examine TS window (Tables view) to the Navigator Tables view.
- Drag and drop (copy/move) from another instance of Multiplexer to the Navigator Tables view.

To add a new stream, highlight ES PIDs in the Navigator Tables view and select Add from the shortcut menu.

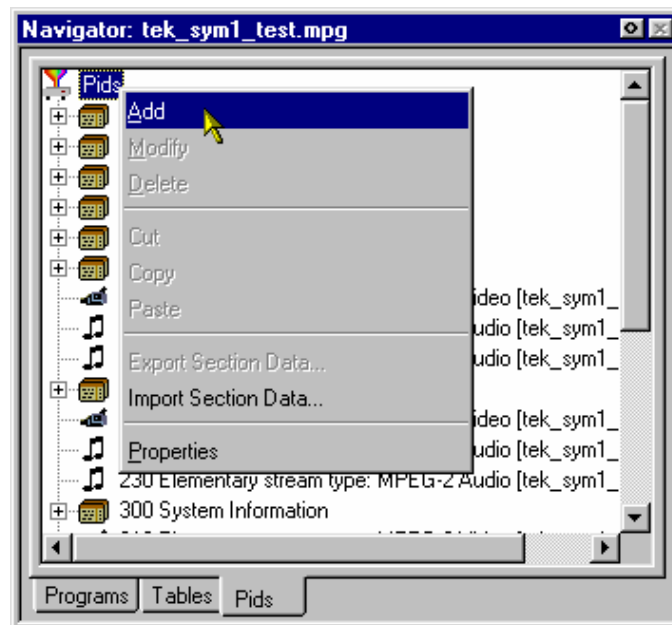

This opens the Add Stream dialog box; the Source tab is displayed by default.

**Defining the PID Source.** In the Add Stream dialog box, select the Source tab; this allows the PID source to be selected and defined.

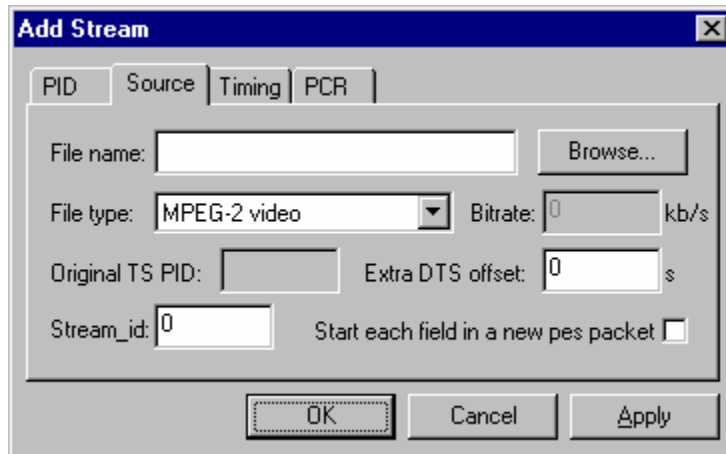

**File name** Enter the file name of the stream to be multiplexed. If the file name is unknown, select Browse to open a standard file browser dialog and locate the file required.

The names of files being copied to the multiplex will be automatically filled in.

**File type** Select the type of file to be multiplexed from the drop-down list box.

The following file types are available:

- MPEG-1 video ES or PES
- MPEG-2 video ES or PES
- MPEG-2 audio ES or PES (MPEG-1 or MPEG-2)
- MPEG-2 AAC audio ES or PES (ADTS format only)
- AC-3 audio ES or PES
- (ES - Elementary Stream;
- PES - Packetized Elementary Stream)
- H.264 video ES or PES

Transport Packets: A single PID stream. The Bit rate value will require setting. The Original TS PID will require setting.

Section: The content of the file will be Sections. The sections will be in binary form. The file will consist of one, or many sections appended one after the other.

When multiplexed, the sections will be encoded on the given PID as SI. If the resulting multiplex is subsequently opened in the Multiplexer, the sections will be interpreted as SI and displayed under the SI Tables node in the tree.

A file generated using the Edit > Export Section Data menu option can be used here. The Bit rate value will require setting.

Other: Any binary or ASCII file that is to be packetized into the transport stream at the specified bit rate. The Bit rate value will require setting.

The remaining fields are interactive and will only be enabled when a value is required.

Bitrate	When first defining a source, the bit rate is unknown and 0 Kbps is displayed. If a Transport Packet Stream or an “Other” File Type is selected, the field is enabled and a value (in Kbps) can be entered. If MPEG-2 video or H.264 video with SEI messages is selected, the bit rate value is detected automatically and displayed. If H.264 video without SEI messages is selected, the bit rate is not detected automatically.
Original TS PID	For streams other than transport streams, this field will be blank and disabled.
Extra DTS offset	When multiplexing ES or PES streams, the Multiplexer will derive an offset between the PCR and the decoded timestamp (DTS) of the first access unit (video picture / audio frame).  You can override this offset and make it larger (positive number) or smaller (negative number). Changing this value may cause the resultant stream to be nonconformant with respect to the T-STD of the MPEG-2 standard. Enter the DTS offset in seconds required.

Stream_id	<p>Only enabled for elementary stream types. This number specifies the value of the stream_id field in the PES packet header.</p> <p>Only needs to be set for DVB stream. Stream identity in the PES header.</p>
Start each field in a new PES packet	<p>Only enabled when File Type: MPEG-2 Video is selected.</p> <p>When disabled, both field pictures making up a coded frame are put in a single PES packet. Otherwise, each field picture is put into a separate PES packet. This setting has no effect upon frame pictures.</p>
Start each section in a new packet	<p>Only enabled when File Type: Section is selected.</p> <p>When disabled, SI data is placed in the packet payloads in the most efficient manner. The start of a section will immediately follow the end of the previous section; no stuffing bytes will be used.</p> <p>When enabled, each section will begin in a new packet and stuffing bytes will be used to pad any payloads that are not full.</p>

**Defining the Stream Timing.** In the Add Stream dialog box, select the Timing tab. This tab will allow timing parameters for the selected source stream to be defined.

**NOTE.** To achieve compatibility between MUX and MTS4EA, the start time is set to the following default values: PAT is 0.000, PMT is 0.001, and ES is 0.002.

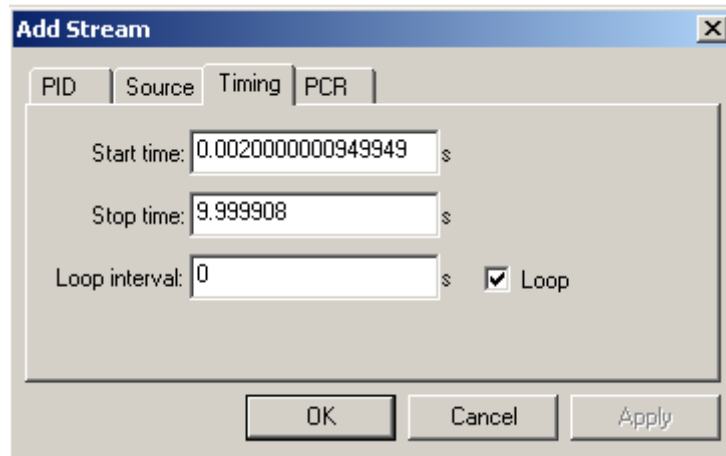

**Start/Stop Time** Enter the times that the selected source stream is to start and stop within the host transport stream. Note that the overall duration of the host transport stream is defined through the Transport Stream Properties dialog box.

**Loop** Select this check box to loop the selected source stream for the duration of the synthesis. A Loop Interval can be set that introduces a delay between each repeat of the source stream; if zero is entered, the source stream will loop continuously. The Loop check box will always be disabled for transport stream types. The Multiplexer cannot loop transport streams.

Select OK to accept all changes and close the dialog box.

**Defining the PCR Placement.** In the Add Stream dialog box select the PCR tab; this will allow PCR placement to be defined.

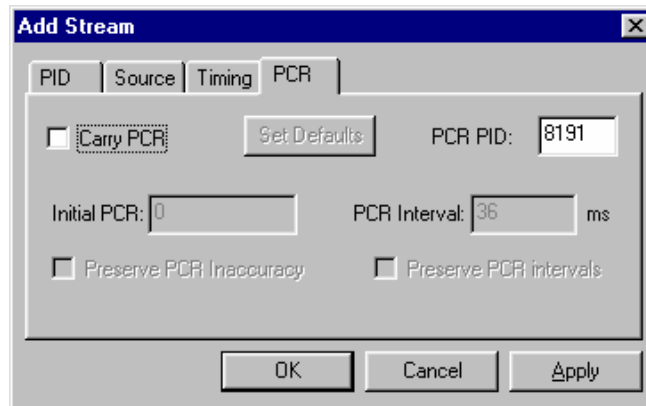

**PCR for Elementary Streams.** (Includes File Type: Transport Packets.)  
PCRs are placed in the packets at the specified interval, starting with the specified initial value.

**PCR for Remultiplexed PIDs.** (Includes File Type: Transport Stream)

- If the Carry PCR check box is not enabled, any PCRs in the packets will be removed.
- If the Carry PCR check box is enabled, PCRs will be sent as follows: If Preserve PCR Inaccuracy is set, the PCRs from the original transport stream will be used, otherwise the initial PCR value can be specified.
- If the Preserve PCR Intervals check box is enabled, PCRs will be sent in those packets that originally contained them, otherwise PCRs are inserted into packets at the specified intervals.

**Specifying the PID Number**

Enter the PID number. A new value can be entered using either decimal or hexadecimal notation. Values are assumed to be decimal unless preceded with 0x. The dialog box is not case sensitive and values may include zeros after the prefix and before any significant digits.

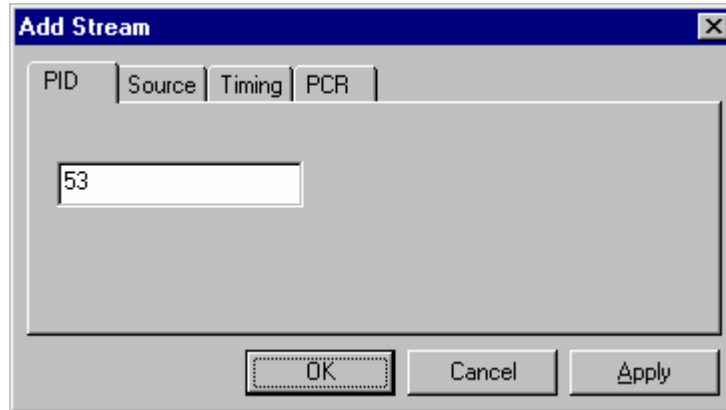

When all details (in all tabs) are satisfactory, select OK to accept all changes and close the dialog box.

**Adding Elementary Streams to the Program Structure****Methods available:**

- Highlight an Elementary Stream node in the Navigator Programs view and select Add from the shortcut menu.
- Drag and drop (copy only) from the Examine TS window (Programs view) to the Navigator Programs view.
- Drag and drop (copy/move) from another instance of Multiplexer to the Navigator Programs view.

Elementary stream data can be added using the Navigator Programs view.

1. In the Navigator Programs view, highlight an Elementary Streams node to which the elementary stream is to be added.
2. From the shortcut menu, select Add. The Add Program Stream dialog box is displayed.

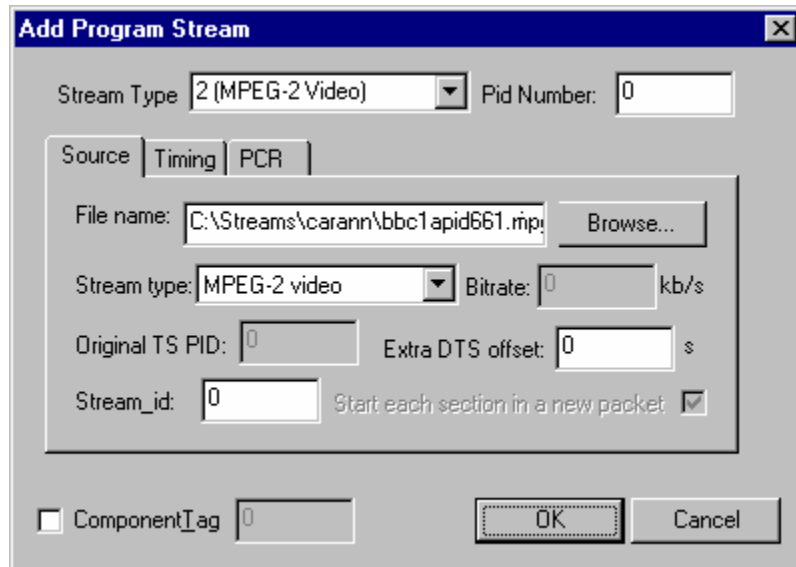

The dialog box tabs allows the input elementary stream to be selected and specified. The main dialog box fields Stream Type and Pid Number dictate the PID that will carry the stream and the stream type entry that will be made in the PMT.

3. The functionality of the tabbed dialog boxes is described in the following pages:

Source	See <i>Defining the PID Source</i> , page 8–100,
Timing	See <i>Defining the Stream Timing</i> , page 8–103,
PCR	See <i>Defining the PCR Placement</i> , page 8–104.

4. Enable the Component Tag check box, if required. Enter a Component Tag number (0 - 255) in the enabled field. If the Component Tag is enabled, it can be referenced by other tables, for example, Event Information Table.



### **Exporting Elementary Streams**

The Export Elementary Stream option allows the nonpacketized elementary stream data to be extracted from an elementary stream and saved to a binary file. Note that this data will not include the transport packet or the PES packet headers.

In the Navigator Programs view, highlight the elementary stream whose payload is to be exported. Select the Export Elementary Stream... option from the shortcut menu. Name the file to be created and choose a location. Select Save to confirm the action.

### **Exporting PES Packets**

The Export Payload option allows the PES packets to be extracted from an elementary stream and saved to a binary file. Note that this data will not include the transport packet headers.

In the Navigator Programs view, highlight the elementary stream whose payload is to be exported. Select the Export Payload option from the shortcut menu. Name the file to be created and choose a location. Select Save to confirm the action.

### **Modifying PES PID Details**

To modify any of the ES PID parameters, highlight the required PID in the Navigator Tables view and select Properties from the shortcut menu. The Stream Properties dialog box and its tabs are identical to the Add Stream dialog box. Refer to *Adding an Unreferenced Elementary Stream*, page 8–99. Locate the parameter to be changed, and click OK when changed.

ES PID parameters can also be modified in the Navigator Programs view. Highlight an Elementary Stream in the Programs view and select Properties from the shortcut menu. The dialog box thus displayed (Program Stream Properties) is similar to the Add Program Stream dialog box shown on page 8–105.

### **Deleting a PES PID**

An elementary stream can be removed from the multiplex by deleting the PID. To delete a PID, highlight the required PID and select Delete from the shortcut menu. Then select the Delete option from the Edit or pop-up menus. Alternatively, click the delete button from the toolbar.

Multiplexer asks for confirmation before removing the PID from the multiplex. Select Yes to delete the stream or No to abandon the operation and leave the stream unchanged.

## DSM-CC

### Adding an Unreferenced DSM-CC Section

#### Methods available:

- Highlight the ES PIDs node in the Navigator Tables view and select Add from the shortcut menu.
- Drag and drop (copy only) from the Examine TS window (Tables view) to the Navigator Tables view.
- Drag and drop (copy/move) from another instance of Multiplexer to the Navigator Tables view.

Adding an unreferenced DSM-CC section is similar to adding an unreferenced elementary stream (see page 8–99), with the following modifications:

In the Source tab of the Add Stream dialog box, select Transport Packets / Sections as the File type and set the bit rate.

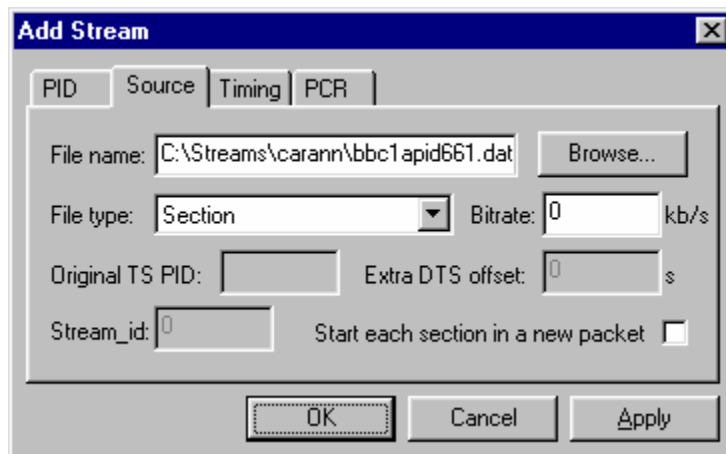

### Adding DSM-CC Sections to the Program Structure

**Methods available:**

- Highlight an Elementary Stream in the Navigator Programs view and select Add from the shortcut menu.
- Drag and drop (copy only) from the Examine TS window (Programs view) to the Navigator Programs view.
- Drag and drop (copy/move) from another instance of Multiplexer to the Navigator Programs view.

Adding a DSM-CC section to the program structure is similar to adding an elementary stream to the program structure (see page 8–99), with the following modifications:

- The main dialog box fields Stream Type and Pid Number dictate the PID that will carry the stream and the stream type entry that will be made in the PMT. The Stream Type should be set to one of the DSM-CC entries.

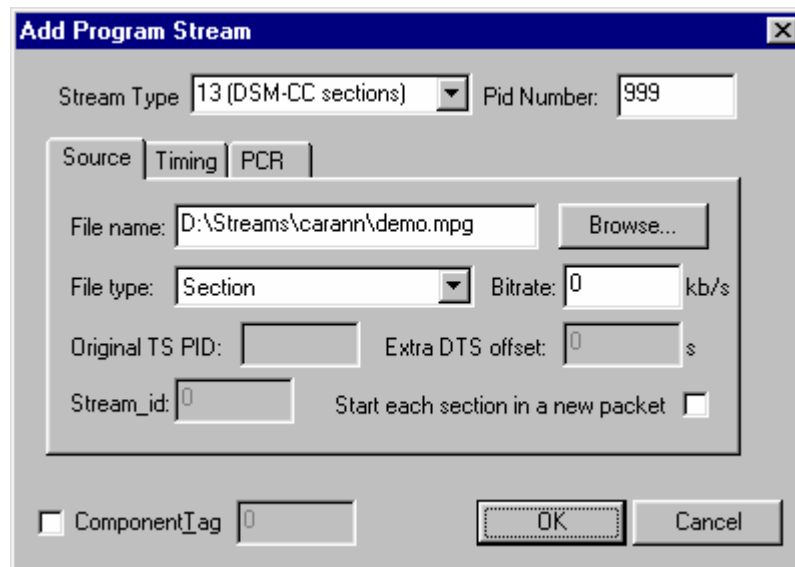

- In the Source tab of the Add Program Stream dialog box, identify the File name to be added. Select Transport Packets / Sections as the Stream type and set the bit rate.

The DSM-CC section will be added.

### Delete a DSM-CC Section

A DSM-CC section can be deleted from a table by highlighting it in the Navigator view and selecting Delete from the shortcut menu. To delete more than one section, select and delete each one in turn.

### **Export a DSM-CC Section**

DSM-CC data can be exported in the form of a binary file.

Highlight the required DSM-CC section in the Navigator Tables view. From the shortcut menu, select Export Section Data. Name the file to be created and choose a location. Select Save to confirm the action.

Individual DSM-CC sections can also be exported using the Navigator Programs view. Under any Elementary Streams node, highlight the DSM-CC section to be exported. From the shortcut menu, select Export Section Data.... Name the file to be created and choose a location. Select Save to confirm the action.

# Editing in Section View

Use the Section View window to modify the contents of a version/section. This includes version, section, and table-specific data that the Navigator Tables view displays. If the Section View window is not already open, select View > Section View.

If a section/version is selected in the Navigator Tables view, the contents are automatically displayed in the Section View; otherwise the Section View window is blank.

To open a table version/section in Section View, select the component in the Navigator Tables view. The Section View is updated immediately to show the selected section/version.

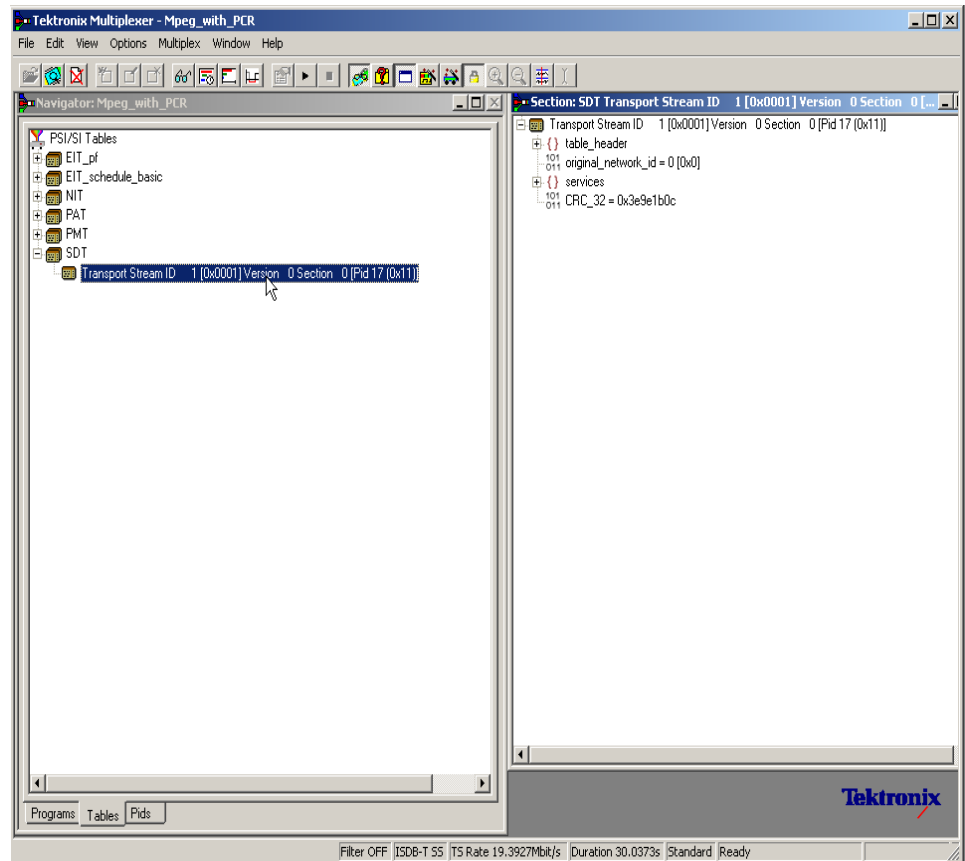

## Editing Fields

To add, change, or delete a field, element or loop in a section/version, the parent table must be selected in the Navigator Tables view. Highlight the appropriate line in the Section view and select the required option from the shortcut menu.

### Selecting a Field

To select a field or container, place the mouse pointer over it and click the left button.

The magnifying glass icon indicates the selected component.

If Standard Mode is selected, the magnifying glass selection cannot be placed on a field that is locked. To select and edit locked fields, first select the Expert Mode option from the Multiplex menu.

**Adding an Element to Loop**

To add an element to a loop, select the parent loop that will contain it, and then select Add from the shortcut menu. For example, to add a program to a PAT, highlight the Programs container and select Add from the shortcut menu.

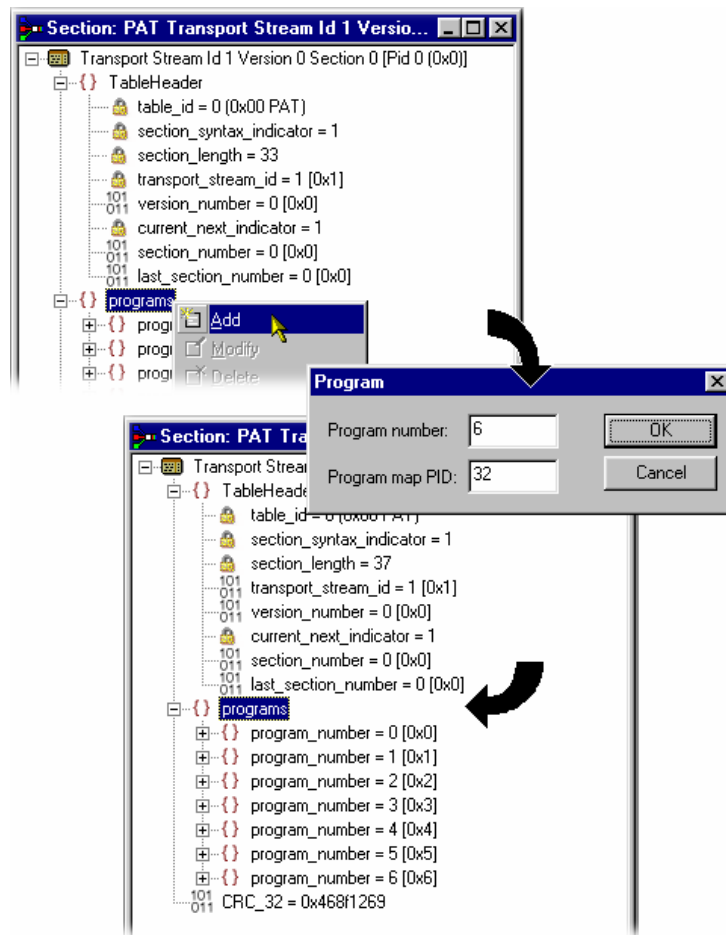

In this example, a dialog box is displayed in which the Program Number and Program Map PID can be accepted or respecified. Other table loops may not display any dialog box, but immediately create a new element with default contents. An entry is displayed for the new element, with its details collapsed, at the end of the list of elements in the loop. In addition, the section length field is automatically recalculated and amended. For the above example the new entry is program\_number = 6 (0x6).

---

**NOTE.** *The example above was taken with Standard mode selected. In Standard mode, all recalculation is done automatically. In Expert mode, a program element will be added, but the program number and PID must be manually adjusted. Similarly, the section length will need to be calculated and amended manually (see also Expert and Standard Modes, page 8–60).*

---

**Deleting an Element in a Loop**

To delete a loop element, in the Section view, highlight the element and select Delete from the shortcut menu.

The element is deleted and the Section View window updated to reflect the changes.

**Modifying the Contents of a Field**

To edit the contents of a field, highlight the field and select Modify from the shortcut menu. This will open an appropriate dialog box for modifying the type of data held by the field.

The following paragraphs describe the different types of data that may be modified.

**Enumerated Value.** The Modify value dialog box displays the name of the field and the current value. The value is shown as a number followed by the interpretation of the governing standards.

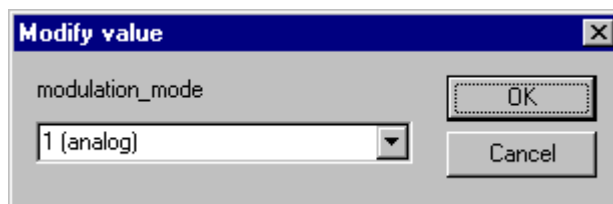

In this figure the field being edited is a modulation\_mode and the current text is 1 (analog).

Type the number, without any text, for the required value. When the changes are accepted, Multiplexer will display the interpretation in the Section View window.

Alternatively, click the down arrow to select the value from the drop down list.



This displays a list of the defined values and their interpretation. The list will vary depending upon the field being edited.

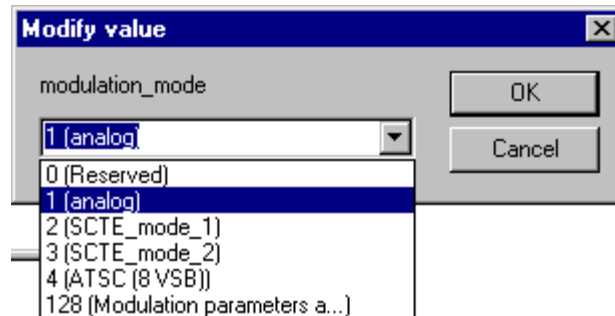

Enter the required value and select OK to continue. Multiplexer may open a simple context-sensitive dialog box offering advice and/or asking for more information or confirmation. An error message is displayed if the number that was typed in requires more bits than are allocated to the field.

**Date and Time.** The Modify Time dialog box displays the name of the field. It displays the time in both interpreted and raw formats; only the interpreted mode can be edited.

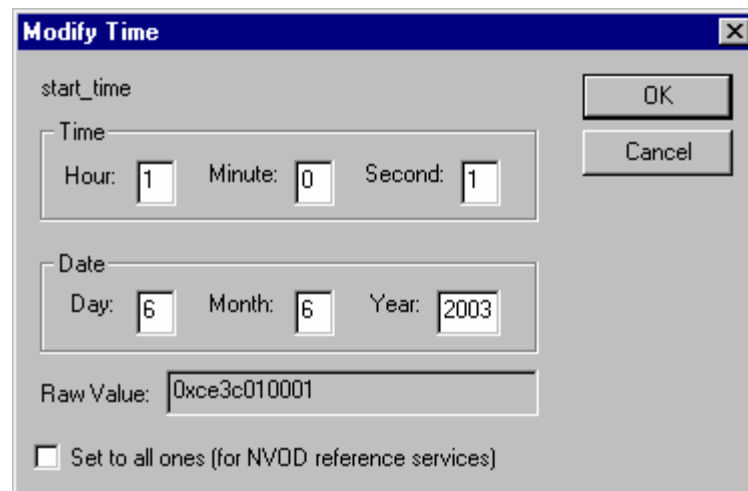

Edit the numbers in any of the fields as required. All fields are updated as each digit is added, changed or deleted. Select OK to commit the changes or Cancel to abandon editing and keep the original time.

The Set to all ones check box, when enabled, sets the 40-bit date field to 0xFFFFFFFF. This may be required when setting the start\_date for an event in a Near Video on Demand (NVOD) reference service.

**Compressed String.** The Modify dialog box displays the name of the field, which is always a compressed string, and the contents of the selected string segment. Text can be entered, deleted, selected, copied to and pasted from the Windows clipboard.

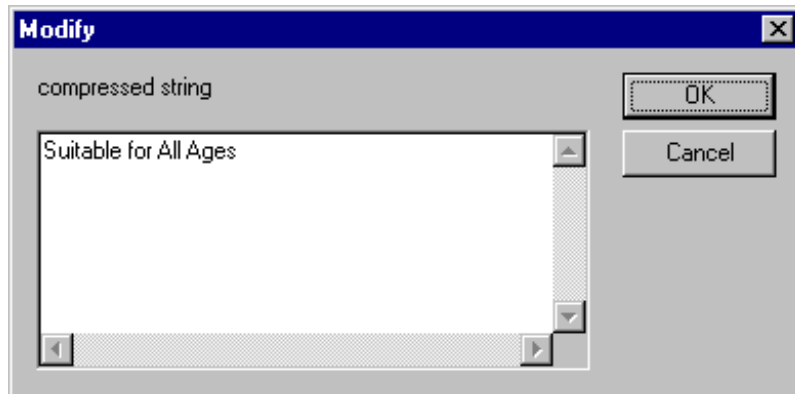

Edit the text and select OK to continue. Select Cancel to abandon the edits and leave the original segment unchanged. Multiplexer checks to ensure that the new string length does not cause the total section length to exceed the maximum specified by the standards.

If the total section length exceeds the maximum specified by the standards, an error message is displayed:

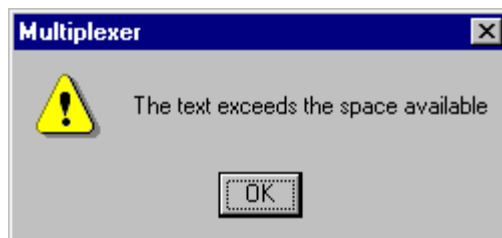

Select OK to return to the Modify dialog box and shorten the string.

**Text.** The Modify Text dialog box displays the name of the field and the current text on a single line. Text can be entered, deleted, copied to and pasted from the Windows clipboard.

In the following figure, the field being edited is an ISO\_639\_language\_code and the current text is eng.

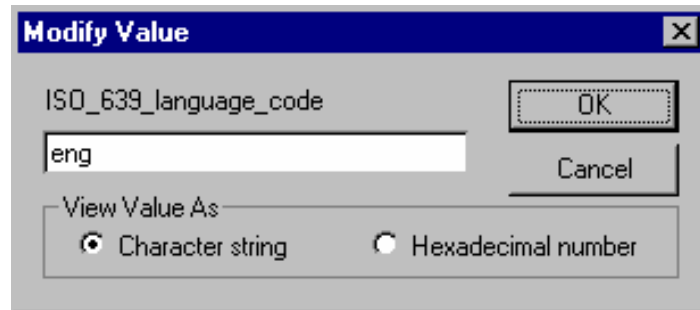

**View Value As** You can choose between viewing the text as an ASCII character string or a hexadecimal sequence.

Most text strings have a maximum length, specified by the governing standards, which this dialog box will enforce. Edit the text and select OK to continue. Select Cancel to abandon the edits and leave the original text unchanged.

**Numeric.** The Modify dialog box displays the name of the field and the current value in decimal. Edit the existing value or type in a new value.

In the following figure, the field being edited is a version\_number and the current value is 0xc.



A new value can be entered using either decimal or hexadecimal notation. Values are assumed to be decimal unless preceded by 0x. The dialog box is not case

sensitive and values may include zeros after the prefix and before any significant digits, for example:

Edit or replace the existing value and then select OK to continue. Select Cancel to abandon any changes made in the field.

Multiplexer will check the new value against the governing standards and for conflicts with other fields. It may open a simple context-sensitive dialog box offering advice and/or asking for more information or confirmation. For example: when changing a version\_number, a dialog box is opened to determine the scope of the change.

# Multiplexing Transport Streams

The Multiplex Engine in the Multiplexer synthesizes a new transport stream and writes it to an MPEG file. The contents of the new stream are multiplexed according to the specification currently held in memory, which is shown in the Navigator and Section views.

The tables that are displayed in the Navigator are synthesized from the current specification. Elementary streams and other data are acquired from the original MPEG file and other stream files and remultiplexed according to the specification.

## Starting the Multiplex Engine

To start the Multiplex Engine, select the Start option from the Multiplex menu. Alternatively, select the start button on the Toolbar.

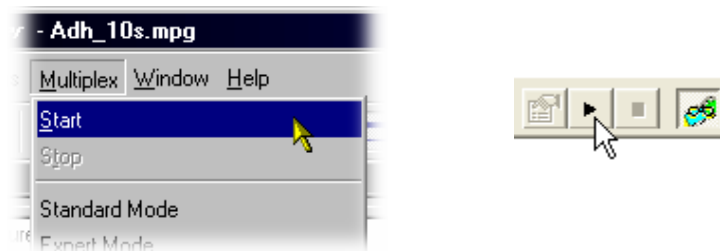

Multiplexer opens a standard file browser dialog box to specify the file name and path for the synthesized transport stream.

A new file can be created or an existing file can be selected to be overwritten. The program will seek confirmation before overwriting an existing file.

---

**NOTE.** *The Multiplexer automatically creates 188 byte packets in the transport stream output file, regardless of the source material size.*

---

## Errors and Reporting

The right pane of the status bar indicates progress as the Multiplex Engine synthesizes the new transport stream.

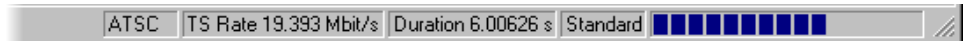

Any errors are recorded in the Event Log, which can be opened at any time before, after and during processing. Here is an example where a table cannot be multiplexed into the new stream at the specified rate.

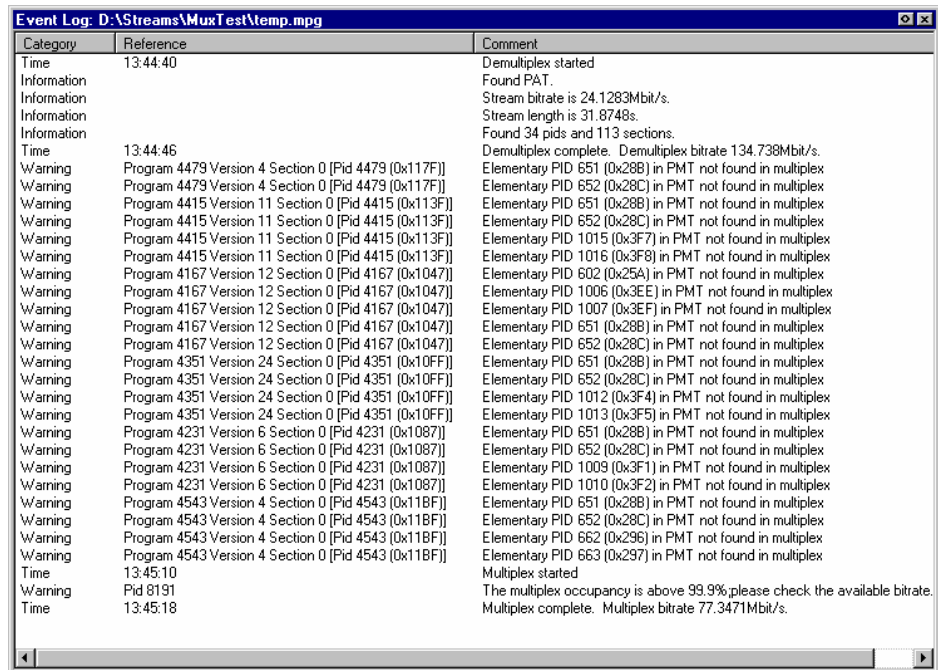

Each table has a specification for nominal and maximum interval, in milliseconds, between instances of the table. These can be edited using the Navigator. The multiplex engine will try to multiplex the table into the synthesized transport stream at the nominal repetition rate. Errors are reported whenever packets for any PID cannot be encoded at their specified minimum rate.

The complete text may be copied onto the Windows clipboard, using the Copy option from the shortcut menu. The text can also be cleared with the Clear command. Both commands are also available from the Edit menu.

## Stopping the Multiplex Engine

The Multiplex Engine can be stopped at any time while it is running. This will abandon processing and close the file. The file will contain all of the packets synthesized up to the time the engine was stopped.

To stop the Multiplex Engine, select **Multiplex > Stop**.

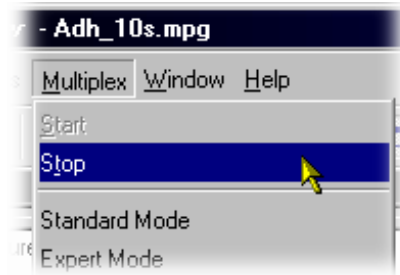

Alternatively, select the stop button on the Toolbar.



## Exporting the Multiplex Configuration File

**NOTE.** *Multiplexer is used for generating both conformant and nonconformant streams. Use the Export and Export As options to save copies of the specification for nonconformant streams in a multiplex configuration file. This file does not include a copy of the transport stream, instead, it refers to the original MPEG file by name and location.*

*The multiplex configuration file can be reopened using the Import option (see page 8-12).*

---

**Export** Select File > Export to save any changes to the current multiplex configuration file. Alternatively, use the Ctrl+E keyboard shortcut.

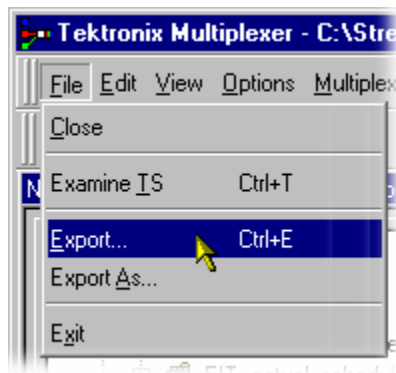

If a multiplex configuration file has not been opened, Export opens a standard file browser dialog box to specify the file. This is the same as selecting the Export As... option.



**Export As** File > Export As exports a file with a user-specified name.

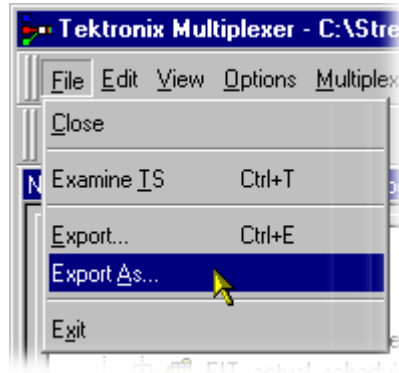

Multiplexer opens a standard file browser dialog box to select an existing file or specify a new file.

If you are creating a new file, specify the name of the exported file and select where it will be saved. By default, files are created with .mxml as the file extension.



# Make Seamless

When you loop a transport stream to simulate continuous playout, errors can be generated at the loop point caused by discontinuities in timing information. The Seamless option provides the opportunity of creating seamless MPEG-2 files.

The option can be set up and enabled so that all multiplex operations result in seamless output or none.

## Enabling the Seamless option

Toggle the Seamless option by selecting Multiplex > Seamless or the toolbar button  .

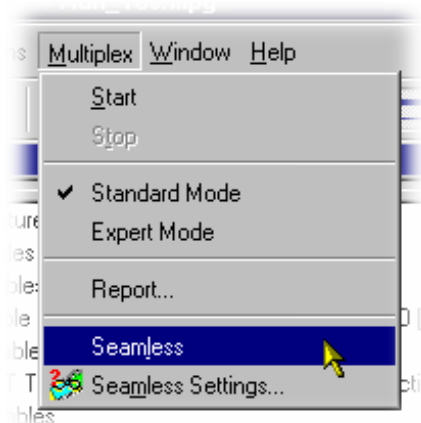

## Seamless Settings

Open the Seamless Settings dialog box by selecting Multiplex > Seamless Settings.... The dialog box shown below is displayed.

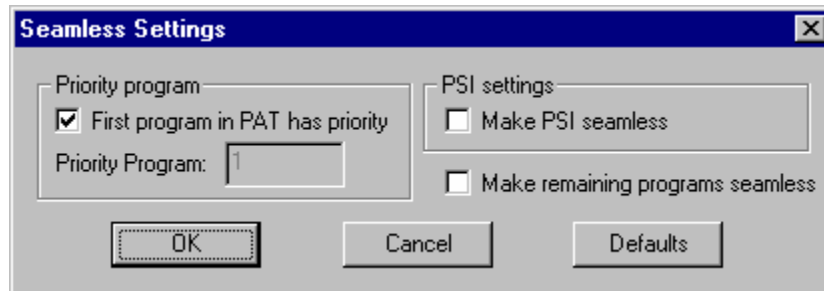

### Priority Program

First program in PAT has priority

If this setting is enabled, the first program specified in the PAT will be given priority in the make seamless process.

If the setting is disabled, the priority program can be specified in the Priority Program. The number can be deduced by inspecting the results of the transport stream analysis.

### PSI Settings

Make PSI seamless

If enabled, the service information contained in the transport stream is processed to make it seamless.

If the setting is disabled, the PSI/SI is not processed but simply copied to the output transport stream.

Make remaining programs seamless

If enabled, the remaining programs are made seamless but are constrained by limits defined by the priority program. This may lead to these remaining programs having a gap at the beginning and end of the file.

# Reference

## Abbreviations

AIT	Application Information Table
ASCII	American Standard Code for Information Interchange
ATSC	Advanced Television Systems Committee
CAT	Conditional Access Table (MPEG)
CDT	Carrier Definition Table
CVCT	Cable Virtual Channel Table (ATSC)
DSM-CC	Digital Storage Media - Command and Control
DTS	Decoding Time Stamp
EIT	Event Information Table (DVB/ATSC)
ES	Elementary Stream
ETT	Extended Text Table (ATSC)
MGT	Master Guide Table (ATSC)
MMT	Modulation Mode Table
NIT	Network Information Table (DVB)
PAT	Program Association Table (MPEG)
PES	Packetized Elementary Stream
PID	Packet Identifier
PIT	Program Information Table (ATSC)
PMT	Program Map Table (MPEG)
PSI	Program Specific Information (MPEG)
PSIP	Program and System Information Protocol (ATSC)
PTS	Presentation Time Stamp
RAID	Redundant Array of Independent Disks
RRT	Regional Ratings Table (ATSC)
RST	Running Status Table (DVB)
SDT	Service Description Table (DVB)
SEI	Supplemental Enhancement Information (H.264)
SI	Service Information (DVB)

SIT	Satellite Information Table
STT	System Time Table (ATSC)
TDT	Transponder Data Table (ATSC)
TNT	Transponder Name Table
TOT	Time Offset Table (DVB)
TS	Transport Stream
TSTD	Transport Streams Description Table
T-STD	Transport Stream System Target Decoder
TVCT	Terrestrial Virtual Channel Table (ATSC)
UTC	Universal Coordinated Time
VCT	Virtual Channel Table (ATSC)
VUI	Video Usability Information (H.264)
XML	Extensible Markup Language



# **Transport Stream Editor**





# Table of Contents

<b>Transport Stream Editor</b> .....	<b>9-1</b>
Starting the Program .....	9-2
Options .....	9-3
Opening a File .....	9-4
<b>Menus and Controls</b> .....	<b>9-7</b>
Toolbar .....	9-7
Status Bar .....	9-8
Slider Bar .....	9-9
Menu Options .....	9-11
<b>Hex Editor</b> .....	<b>9-15</b>
Color Coding .....	9-15
Selecting & Editing .....	9-17
<b>Header Editor</b> .....	<b>9-21</b>
Header Information Tab .....	9-21
Adaptation Field Tab .....	9-23
Adaptation Field Extension Tab .....	9-26
<b>PID Remapping</b> .....	<b>9-29</b>
<b>PCR Recalculation</b> .....	<b>9-33</b>
Jitter Functions .....	9-38

## List of Tables

<b>Table 9-1: File menu options</b> .....	<b>9-11</b>
<b>Table 9-2: Edit menu options</b> .....	<b>9-11</b>
<b>Table 9-3: View menu options</b> .....	<b>9-12</b>
<b>Table 9-4: Tools menu options</b> .....	<b>9-13</b>
<b>Table 9-5: Help menu options</b> .....	<b>9-13</b>

# Transport Stream Editor

The Transport Stream Editor can be used to edit the contents of transport stream packets contained in a file. It displays the complete contents of each packet in hexadecimal and provides an interpreted view of the packet header information.

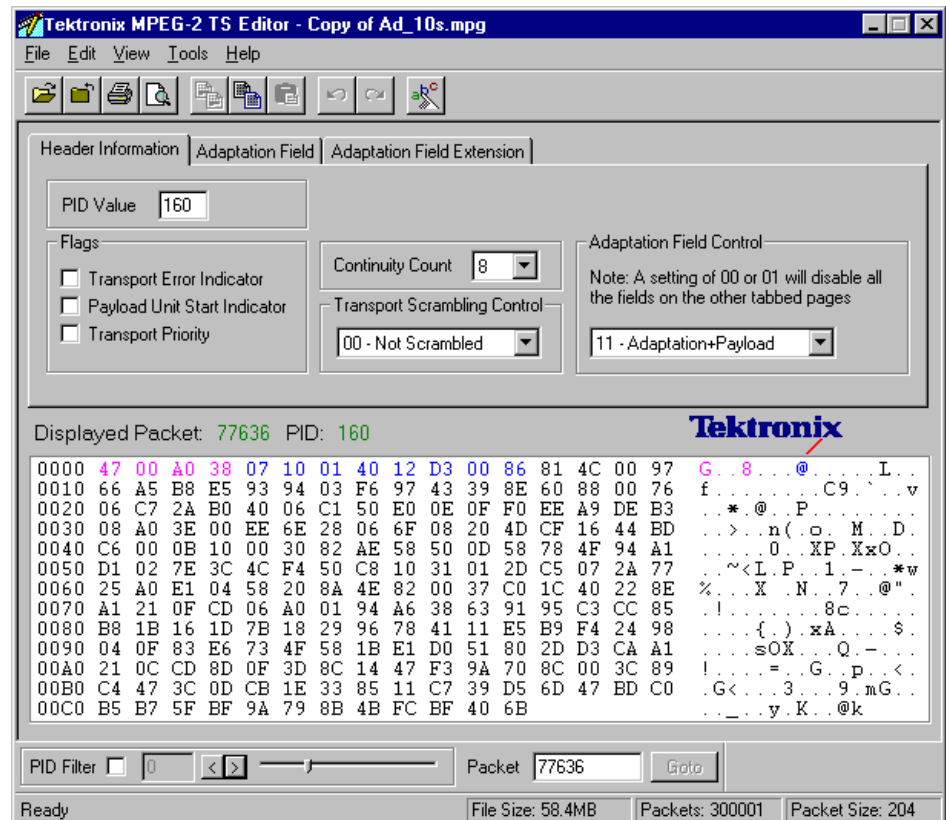

Packet headers can be edited from both the header interpretation and hexadecimal displays. These are referred to as the Header Editor and the Hex Editor, respectively. All changes made in one view are immediately shown in the other. The Header Editor is context sensitive, only allowing edits that make sense with the other fields in the header. It gives full syntax checking of all changes that are made. The payload and any Reed Solomon data are edited from the Hexadecimal Editor.

On the right of the Hex Editor pane, the ASCII character is displayed. Unprintable characters are shown as a period (dot or full stop).

It is normal to edit a copy of a transport stream. Transport Stream Analyzer can be used to view the original while editing the copy.

## Starting the Program

The program may be started by selecting the Tektronix TS Editor option from the Start > Programs menu or by double-clicking on the Tektronix TS Editor shortcut on the desktop.

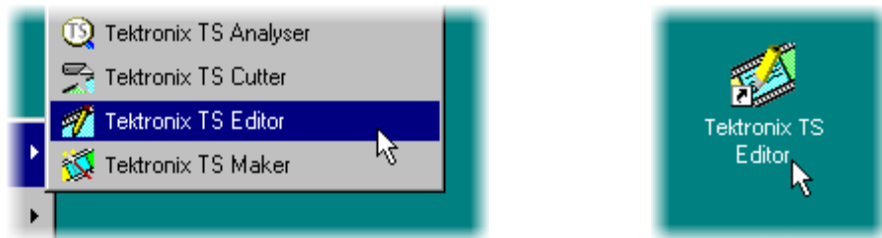

## Initial Appearance

Once the program has started and is ready for use, it will open a Main Window that looks like this:

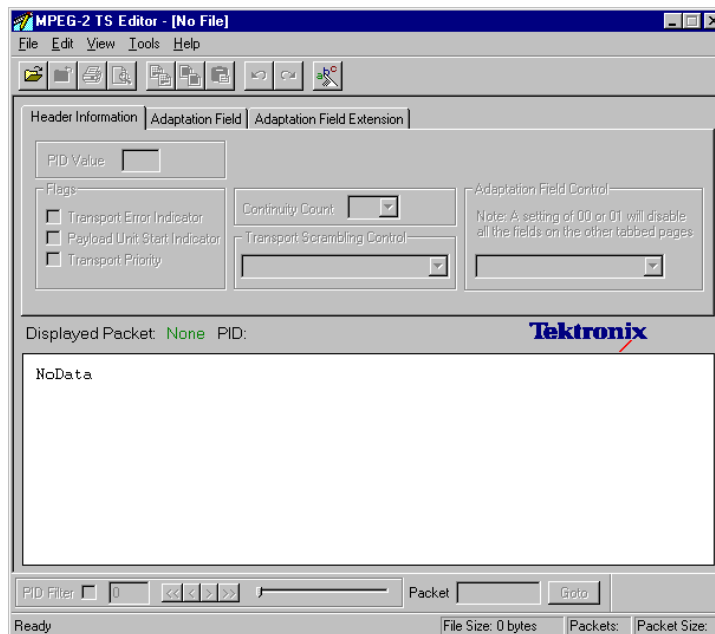

## Options

The Transport Stream Editor has a set of options relating to general use and opening files. It is a good idea to review the options before opening a file.

The settings can be changed at any time by selecting Options... from the Edit menu. This opens the Options dialogue box.

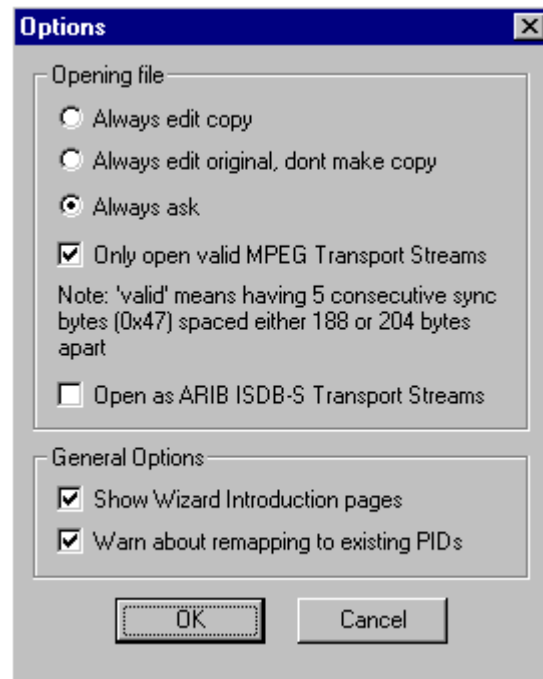

### Opening File

Specifies how the program will interpret the packet size of the stream. The options are mutually exclusive and are as follows:

- Always edit copy  
When opening a file Editor always makes a copy, without asking.
- Always edit original, don't make copy  
Uses the original files without making a copy or asking for confirmation.
- Always ask  
Before opening a file for editing, asks if it should edit the original or make a copy.
- Only open valid MPEG Transport Stream files  
Will open files that have five or more consecutive sync bytes.
- Open as ARIB ISDB-S Transport Streams  
Opens transport streams encoded as ARIB ISDB-S format (including TMCC information).

## General Options

- Show Wizard Introduction pages  
Causes any wizards invoked by Editor to display their Introduction pages.
- Warn about remapping to existing PIDs  
Warns if an operation will remap a PID onto one that is already in use.

## Opening a File

Any stream that is held in a file can be edited with the Transport Stream Editor.

### Opening a File from the Menus and Toolbar

To edit a file, select the Open ... option from the File menu. If the required file is in the list of recently edited files, it may be selected from the list to save using the Open file dialog box.

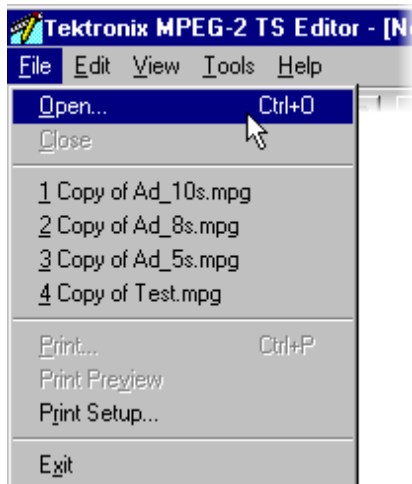

Alternatively, use the Ctrl+O keyboard shortcut.

There is also a shortcut button available on the Toolbar for opening a file, which has the standard file open symbol:



**Opening a File from Windows Explorer or a File Browser Window**

The program can be started and a file opened (with the last set of program options) in a single operation from Windows Explorer or a File Browser Window.

Place the pointer over the file name or icon, press the right mouse button to open a menu, and then select the Edit option.

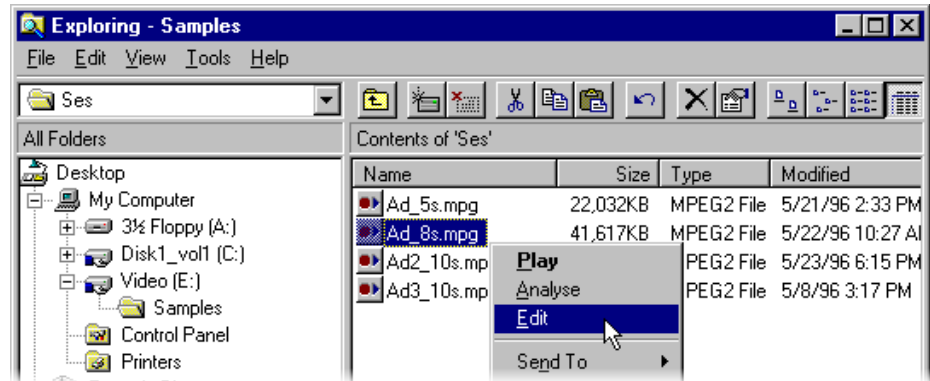

**Copying File before Editing**

TS Editor writes all edits to the file immediately. To avoid accidental changes to prime data, the application can make a copy of the file and edit that copy. By default, once a file has been selected for opening, you are prompted to decide whether to edit the original or make a copy.

If you do not want to be presented with this dialog box each time a file is opened, set the copy or edit original option as the default.

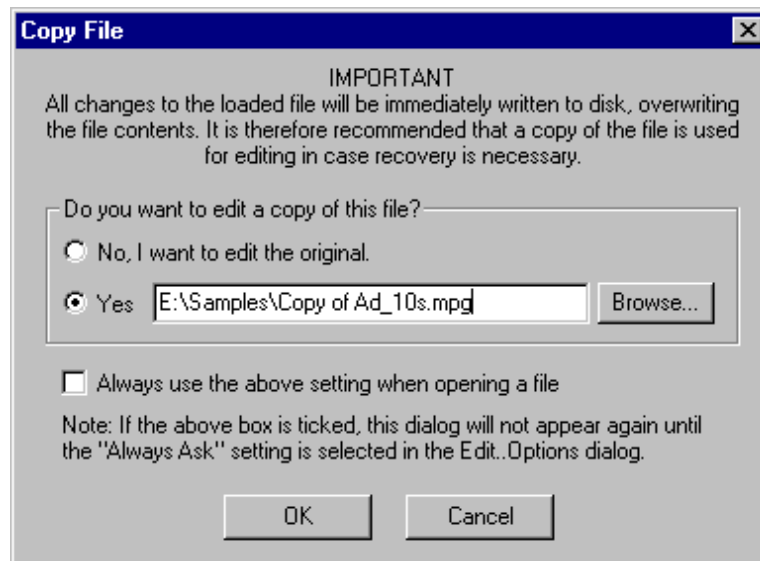

It is recommended that this dialog box be left as the default option.

If someone else has used the MPEG Test System, it is a good idea to look at the Options before opening a file.

To edit the original (useful when making edits to a file that is already a copy) select the No, I want to edit the original option, and then select the OK button.

To make a copy, select the Yes option, specify the copy file, and then select OK. While the copy is being made, the pointer changes to the busy pointer, usually an hour glass.

When the Edit a copy option is selected, the dialog box suggests a suitable filename, which you can edit. To look for a different directory or filename, select the Browse... button. This will open a standard file browser window, like this:

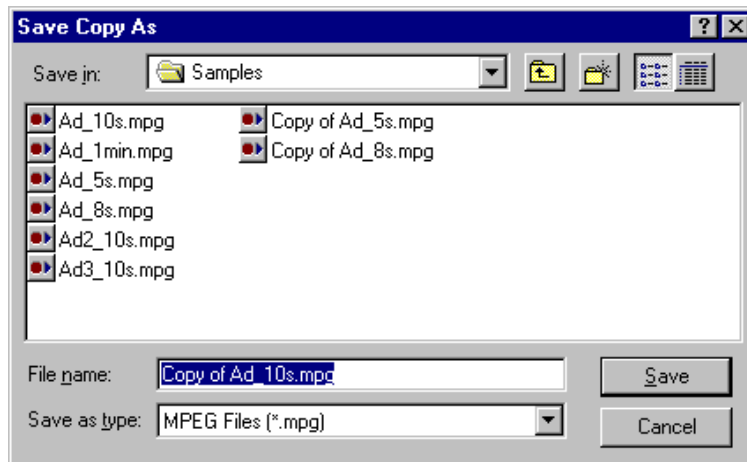













# Menus and Controls

The following pages contain descriptions of the different menu options, toolbar controls, status bar, and slider bar.

## Toolbar



The Toolbar provides a set of convenient shortcuts for the more frequently used menu options. The available commands are:

	Opens a file. If a file is currently open, it will be closed when a new file is selected.
	Closes the current file. There is no save option because all changes are written to file immediately.
	Prints the current packet.
	Opens a print preview of the current packet.
	Copies the bytes that are currently selected in the Hexadecimal Editor from the packet to the clipboard. The bytes are copied using the hexadecimal representation. This button is disabled (grayed out) when nothing is selected that can be copied.
	Copies the entire contents of the current packet to the clipboard.
	Pastes any data, held in the TS Editor's hexadecimal representation, from the clipboard into the packet starting at the currently selected byte.
	Undoes the last edit, restoring the previous value. Selecting Undo again undoes the previous change and so on.
	Reinstates the previously undone change.
	Opens the Options dialog box.

## Status Bar

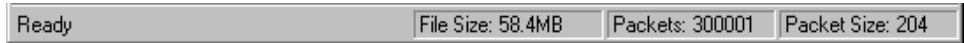

The Status Bar may be hidden from view, but if it is always visible at the bottom of the window. It displays the following information about the program and open file:

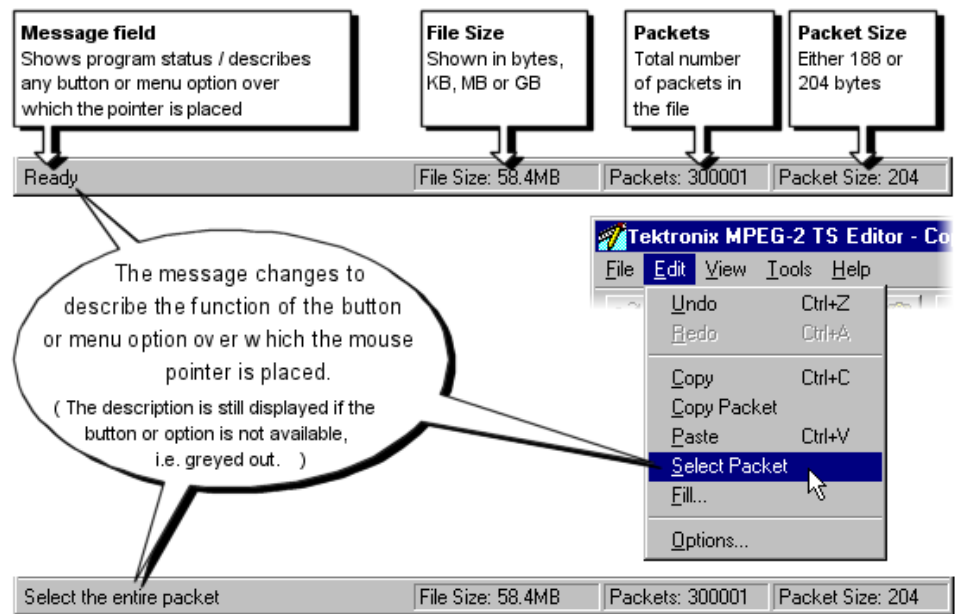

When no file is open, the File Size, Packets, and Packet Size fields are all set to zero or null:



## Slider Bar



The contents of any transport stream packet in the currently open file can be selected using the Slider bar. Packets are numbered according to their position in the file, with the first packet being 0 (zero). The controls in the slider bar are:

### PID Filter

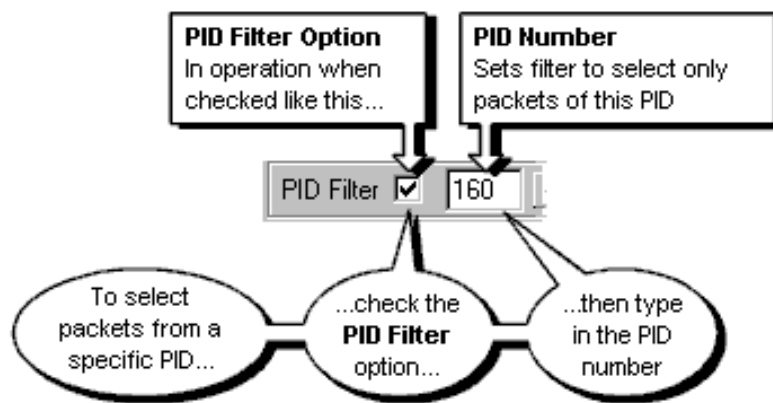

### Slider

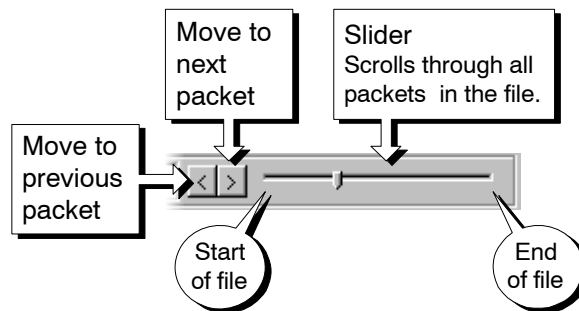

## Packet Number

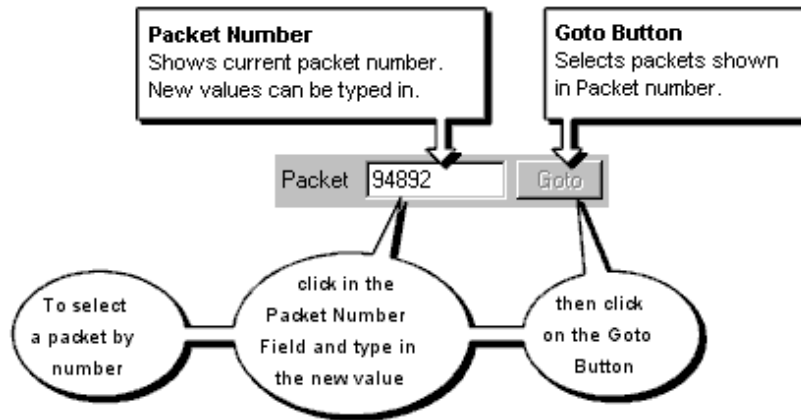

It is normal to edit a copy of a transport stream. Transport Stream Analyzer uses the same packet numbering as Editor. So the packet number can be used to find and view a packet in Analyzer, and then edit the copy of the same packet in Editor.

The Slider Bar can be dragged from the edge of the main window into a floating pallet. To do this, place the mouse pointer on the background (inside the Slider Bar), hold down the left mouse button, and drag the slider bar away from the window border. The result is a self contained window that looks like this:

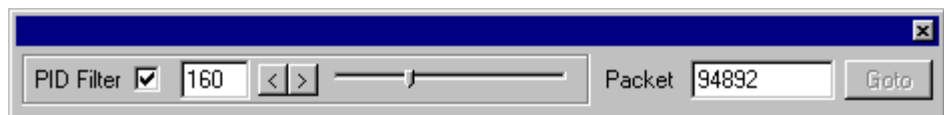

To replace the Slider Bar on the window border drag, it over the border until the outline changes shape.

## Menu Options

The following pages describe all of the menu options. Since many of the options are context sensitive, they will be available only when their function is appropriate for the selected window or display element. When a menu option is not available, the option is grayed out.

**File Menu Options** Table 9–1 list the File menu options.

**Table 9–1: File menu options**

Command	Function
Open	Opens a file for editing. If a file is currently open, it is closed when a new file is selected.
Close	Closes the current file. There is no need for a save option because all changes are written to file immediately.
1 <filename> 2 <filename> 3 <filename> 4 <filename>	A list of the four most recently edited files. If the program has recently been installed, the list may be empty or hold less than four files.
Print	Prints the current packet.
Print Preview	Opens a print preview of the current packet.
Print Setup	Selects printer and configuration.
Exit	Closes any file that is open and terminates execution of the program.

**Edit Menu Options** Table 9–2 list the Edit menu options.

**Table 9–2: Edit menu options**

Command	Function
Undo	Undoes the last edit, restoring the previous value. Selecting undo again undoes the previous change.
Redo	Reinstates the previously undone change.
Copy	Copies the bytes that are currently selected in the Hexadecimal Editor from the packet to the clipboard. The bytes are copied using the hex representation.
Copy Packet	Copies the entire contents of the current packet to the clipboard.
Paste	Pastes hexadecimal from the clipboard into the packet starting at the currently selected byte.

**Table 9-2: Edit menu options (Cont.)**

Command	Function
Select Packet	Selects the entire contents of the packet.
Fill	Prompts for and fills all selected bytes with a value.
Options ...	Opens the options dialog.

**View Menu Options**

Table 9-3 list the View menu options.

**Table 9-3: View menu options**

Command	Function
Toolbar	Shows or hides the Toolbar, which provides a set of convenient shortcuts for the more frequently used menu options.
Status Bar	Shows or hides the Status Bar.
The following menu options select which standard is used to interpret the values held in the Transport Scrambling Code field. Only one standard can be selected at any time.	
MPEG2	Selects the MPEG2 interpretation of the Transport Scrambling Code.
DVB	Selects the DVB interpretation of the Transport Scrambling Code.
ATSC	Selects the ATSC interpretation of the Transport Scrambling Code.

**Tools Menu Options** Table 9–4 list the Tools menu options.

**Table 9–4: Tools menu options**

Command	Function
Remap PIDs...	Starts the tool to Remap packets from one or more PIDS to different PIDS.
PCR Recalculation...	Opens a Wizard to Recalculate the Program Clock References (PCR) carried in one or more PIDS.

**Help Menu Options** Table 9–5 list the Help menu options.

**Table 9–5: Help menu options**

Command	Function
About...	Displays the program version number and license number.





# Hex Editor

The Hex Editor displays and provides editing facilities for the contents of the current packet in both hexadecimal representation and ASCII characters.

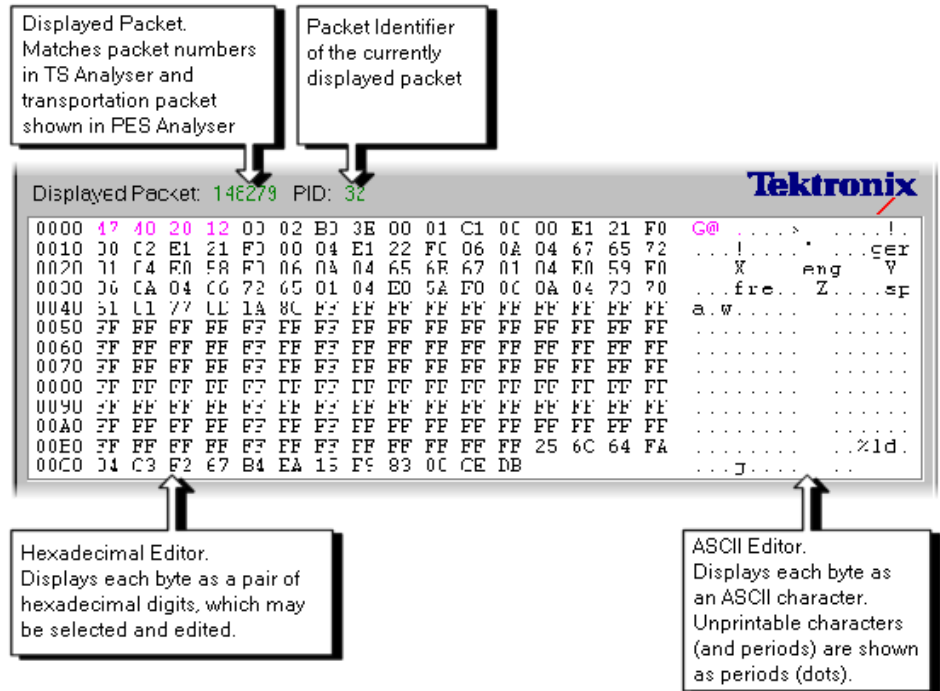

## Color Coding

Color coding is used to show the “footprint” of various header fields, in both the hexadecimal and ASCII views. The packet payload and any Reed Solomon data is shown in black. The bytes of the packet header field are shown in magenta text.

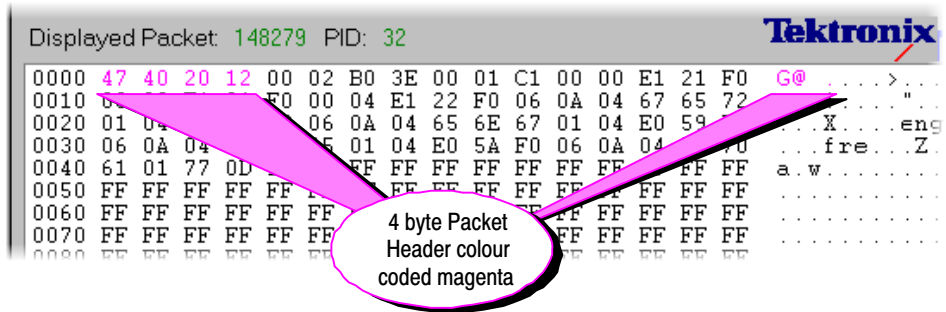

When an adaptation field is present it is shown by blue colored text:

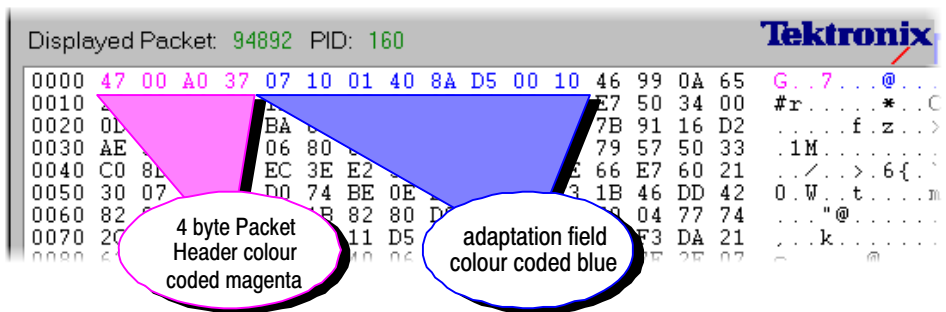

If transport private data is present it is shown in green:

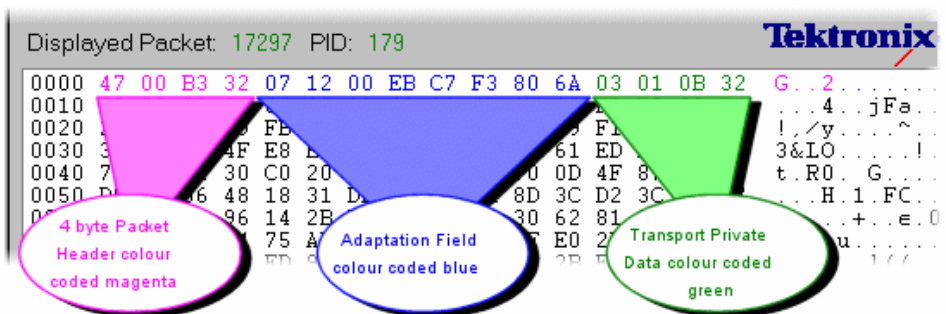

**NOTE.** It is possible to define a transport private data area that is not contained within the adaptation field area specified by the adaptation field length.





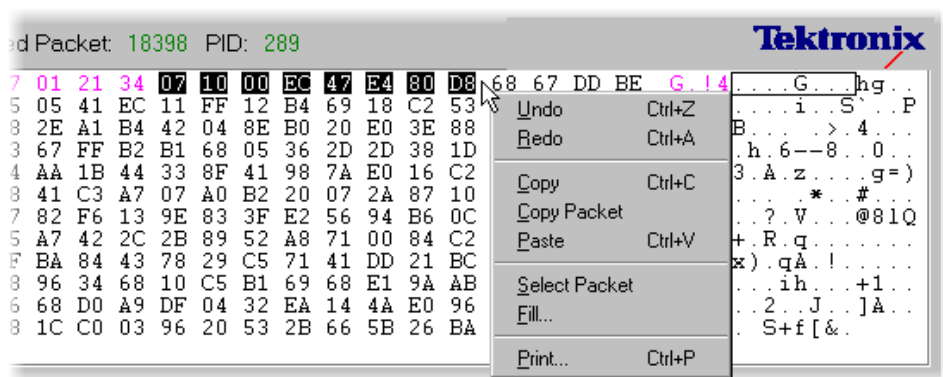

To select a block using the cursor keys: position the cursor on the first byte, and then hold down the Shift key and move the cursor with the cursor keys. The selection is drawn between the initial and current cursor positions. Release the Shift key when the cursor has reached the last byte. Clicking the mouse or pressing a cursor key clears the selection.

### Editing Commands

The Edit menu, pop-up menu, and toolbar buttons provide a variety of options for editing the packet contents. The Pop-Up menu is opened by clicking the right mouse button when the pointer is over the Hex Editor, for example:



Depending on what operations have recently been performed and on what is selected, the menus and toolbar will offer different commands. The complete set of menu options and associated buttons are as follows:

- Undo  TS Editor keeps a list of recent changes. Each Undo command backs out the most recent change from the list. That change is moved to the Redo list in case it needs to be reinstated. As each change is undone the cursor moves to the appropriate field (in the Hex or Header Editors) and restores the previous value.
- Redo  Reinstates the most recently undone operation. When a new edit is made, the Redo list is cleared.
- Copy  Copies the currently selected bytes to the clipboard. From there they may be pasted in to other packets or used by other applications.
- Copy Packet  Copies the entire contents of the current packet to the clipboard. From there it can be pasted into other packets or used by other applications.

- Paste  Pastes packet contents held on the clipboard into the current packet, starting at the current cursor position.
- Select Packet Selects the entire packet. This is a quick alternative to selecting all the packets with the mouse or keyboard.
- Fill Fills all the selected bytes with a hexadecimal value.

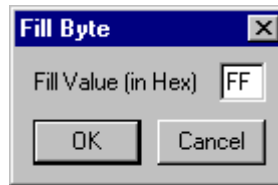

This option opens the Fill Byte dialog box. Enter the fill value then select the OK button. The Cancel button abandons the operation, leaving the bytes in their original state.

There are no Toolbar buttons for the Select Packet and Fill commands.



# Header Editor

The Header Editor has three tabs. These show and allow editing of the basic header, adaptation field, and the adaptation field extension contents. The Hex editor is immediately updated to show the new values when changes are made in the Header Editor.

Binary flags are shown with check boxes whose state can be changed by clicking in the box with the mouse pointer. Multi-bit fields may be edited by typing in the new values or selecting a value from a drop down list.

---

**NOTE.** *It is important to remember that changing a flag or field often alters the structure of the header. The other flags and fields will be reinterpreted according to the data underlying their new position in the structure.*

---

## Header Information Tab

The screenshot shows the 'Header Information' tab selected. It contains the following controls:

- PID Value: 32
- Flags:
  - Transport Error Indicator
  - Payload Unit Start Indicator
  - Transport Priority
- Continuity Count: 2
- Transport Scrambling Control: 00 - Not Scrambled
- Adaptation Field Control: 01 - Payload Only

Note: A setting of 00 or 01 will disable all the fields on the other tabbed pages

The Header Information Tab interprets the contents of the Packet Header (shown in magenta text in the Hex Editor) for ease of understanding and editing.

The PID Value field displays, and allows editing of, the 13-bit PID as a decimal value. (The PID is packed into a pair of bytes with the Flags shown below.)

PID Value 32

The Flags fields display the state of each binary flag in a check box:

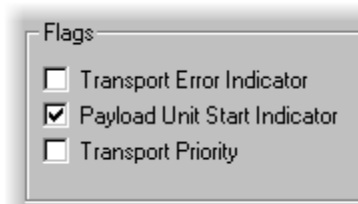

= 0 or false

= 1 or true

Click in the box to toggle the state of a flag.

The Continuity Count field displays the value of the four bit Continuity Count field in decimal.

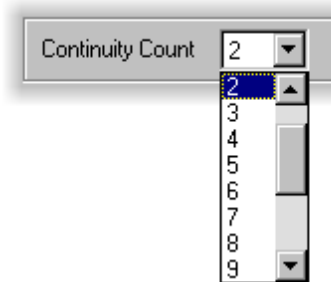

To avoid any typing errors, the drop-down list allows selection of a different value.

The Transport Scrambling Control displays the two bit Transport Scrambling Control field as a binary bit pattern, with a text description.

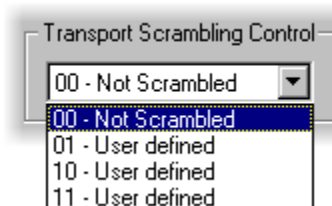

Use the drop-down list to select a different value.



The text gives the interpretation for the bit pattern according to the standard that is currently selected: MPEG2, DVB or ATSC. Use the View menu to select the required option.

The Adaption Field Control displays the two bit Adaptation Field Control as a binary bit pattern, with a text description.

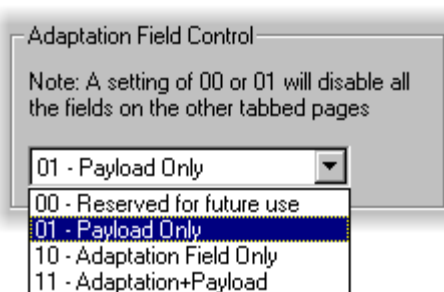

Use the drop-down list to select a different value.

The Adaptation Field and Adaptation Field Extension Tabs will be empty (grayed out) when the 01 - Payload Only or 00 -- Reserved values are selected.

## Adaptation Field Tab

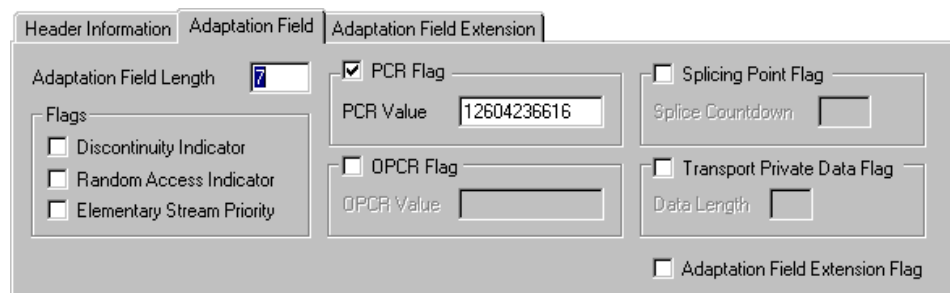

The Adaptation Field Tab interprets the contents of the Adaptation field (shown in blue text in the Hex Editor) if one is present in the packet. To be able to edit an Adaptation Field, the Adaptation Field Control value in the Header Information Tab must indicate that an adaptation field is present.

The Adaption Field Length field shows the length of the Adaptation Field in bytes and allows it to be edited in decimal.



A screenshot of a software interface showing a label "Adaptation Field Length" followed by a text input field containing the number "7".

The Flags fields display the state of the binary flags in check boxes:

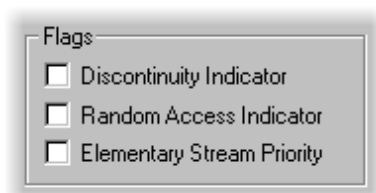

A screenshot of a software interface showing a section titled "Flags" with three checkboxes, all of which are unchecked. The checkboxes are labeled "Discontinuity Indicator", "Random Access Indicator", and "Elementary Stream Priority".

= 0 or false

= 1 or true

Click in the box to toggle the state of a flag.

The PCR Flag field displays the state of the binary PCR Flag in check boxes:

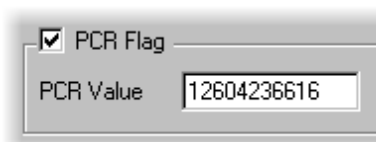

A screenshot of a software interface showing a checkbox labeled "PCR Flag" which is checked. Below it is a text input field labeled "PCR Value" containing the number "12604236616".

= 0 or false

= 1 or true

When the flag is true the PCR Value is shown and can be edited in decimal notation.

The OPCR field displays the state of the binary OPCR Flag in check boxes:

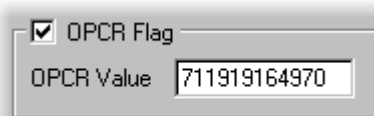

= 0 or false

= 1 or true.

When the flag is true, the OPCR Value is shown and can be edited in decimal notation.

The Splicing Point Flag fields displays the state of the Splicing Point Flag in check boxes:

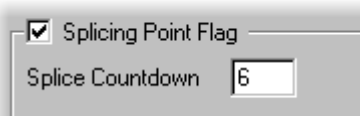

= 0 or false

= 1 or true

When the flag is true, the Splice Countdown value is shown and can be edited in decimal.

The Transport Private Data Flag field displays the state of the Transport Private Data Flag:



= 0 or false

= 1 or true.

When the flag is true, the Data Length is shown in bytes and can be edited in decimal.

The Adaptation Field Extension Flag indicates the state of the binary Adaptation Field Extension flag.



= 0, no Adaptation Field Extension.

The Adaptation Field Extension Tab can be viewed, but all of the fields will be grayed out.

= 1, Adaptation Field Extension present.

The Adaptation Field Extension Tab will show and enable editing of the information contained in the Adaptation Field Extension.

## Adaptation Field Extension Tab

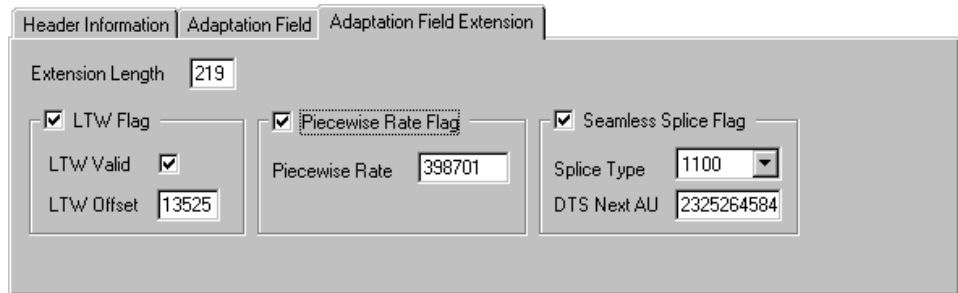

The Adaptation Field Extension Tab interprets the contents of the Adaptation Field Extension if one is present in the packet. To be able to edit an Adaptation Field Extension the Adaptation Field Extension flag must be set to 1 (the box must be checked) in the Adaptation Field Tab.

Shows the length of the Adaptation Field Extension in bytes and allows it to be edited in decimal.



Displays the state of the LTW Flag:

= 0 or false

= 1 or true

When LTW is true, the state of the LTW Valid flag and value of the LTW Offset are shown. The Valid flag may be toggled and new Offsets can be typed in decimal.

Displays the state of the Piecewise Rate Flag:

= 0 or false

= 1 or true

When the flag is true, the Rate is shown and can be edited in decimal notation.

Displays the state of the Seamless Splice Flag:

= 0 or false

= 1 or true

When the DTS Next AU value is shown and it can be edited in decimal notation.

The 4 bit Splice Type is shown as a bit pattern.

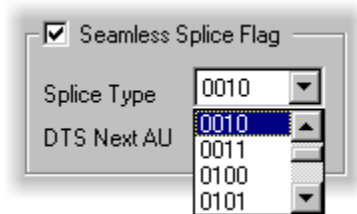

It has a drop-down list containing all 16 possible bit patterns.

Use the list to select a different value.

# PID Remapping

**NOTE.** The packets of one or more PIDS may be remapped (moved to different PIDs). Only the PID in the packet headers is changed. Any packet payload contents, such as SI and PSI tables are unaffected. So remapping can break the references from tables to PIDs, or be used as an investigation to correct broken references.

To remap packets from one or more PIDs, select the Remap PIDs... option from the Tools menu.

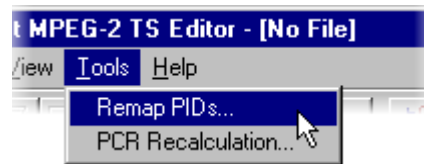

The program scans the file to build a list of PIDs, displaying the Hourglass mouse pointer while it is busy. It then opens the Remap PIDs dialog box:

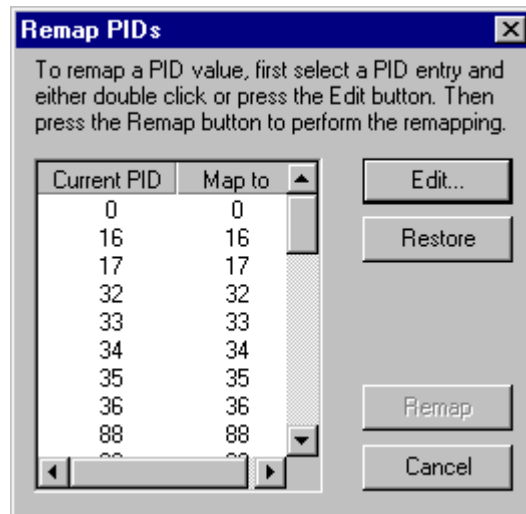

To specify a mapping from a current PID to a new PID, select the current PID entry from the list by clicking on it.

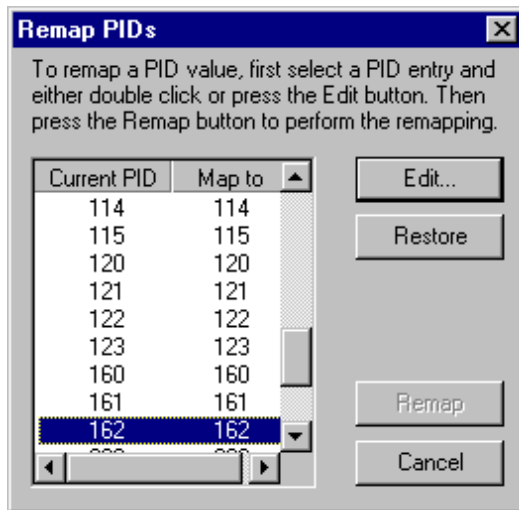

Now select the Edit... button, which opens the PID Entry dialog box. (Alternatively, double-click on the required entry in the list.)

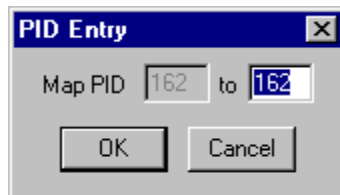

Type in the value for the new PID to map to and select OK.

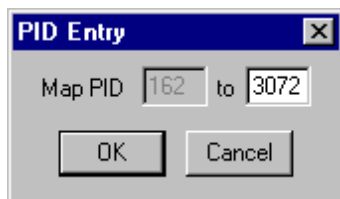

Repeat this process for each PID that is to be remapped.

The Restore button will change the value of the selected Map to PID back to that of the Current PID without having to open the PID Entry dialog.

When all the mappings are specified, select the Remap button. (The Remap button is not enabled unless one or more mappings has been specified.)



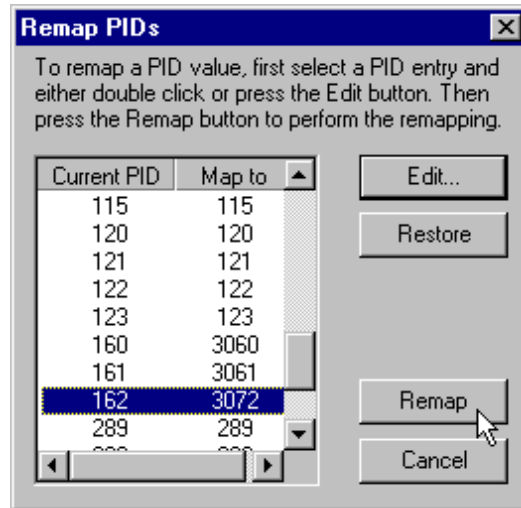

The hourglass mouse pointer is displayed while the program performs the remapping. On completion, the dialog box closes and control is returned to the main window.



# PCR Recalculation

The Program Clock References to one or all Programs can be changed. The rate can be changed and/or any one of six types of jitter added. Uses of PCR Recalculation include:

- Recalculating the rate at the correct value, without adding jitter, on a recording of a faulty stream can be used to remove suspected PCR problems. If the recalculated stream works correctly the problem is in the PCR.
- Creating test data with known deviations in rate for exercising other equipment.

---

**NOTE.** Do not perform PCR Recalculation on an original recording. This operation is not reversible, so it is strongly recommended that a copy of the original file is used.

---

To modify the PCR, select the PCR Recalculation... option from the Tools menu.

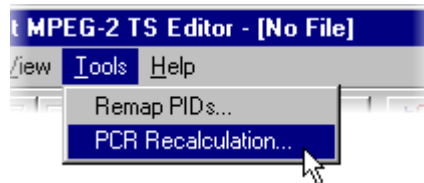

This runs a wizard to analyze the program structure, guide the user through the available options, and then recalculate the PCR values.. The wizard presents 3, 4 or 5 pages depending upon the chosen options:



By default, the wizard will display this Introduction first.

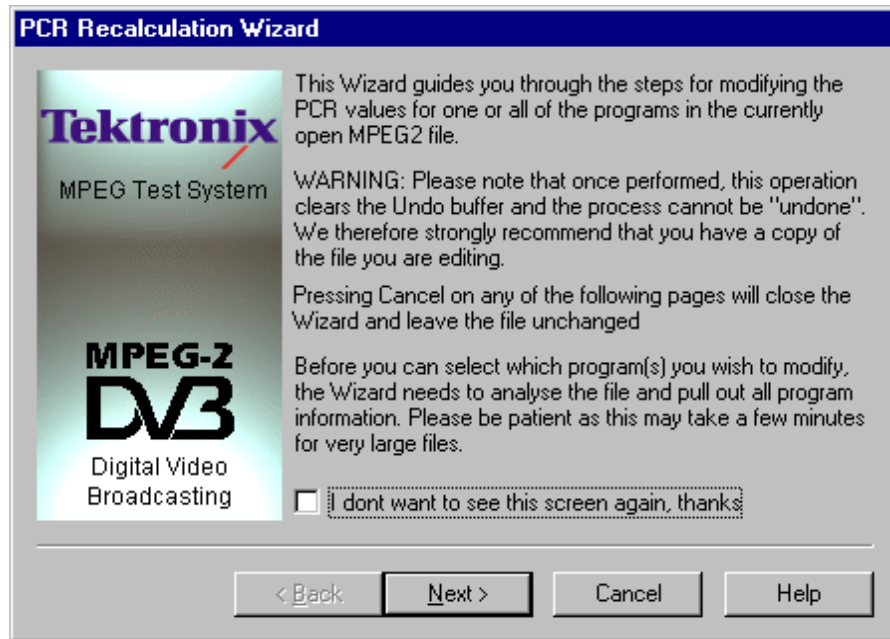

It may be disabled for future recalculations by selecting the check box option at the bottom of the introductory text. Selecting the Next button moves on to the Select Program page.

The wizard has to analyze the file to extract the relevant Program Information, which may take a while. When analysis is complete, the Select Program page shows a list of the programs whose PCR values may be changed (see following illustration).

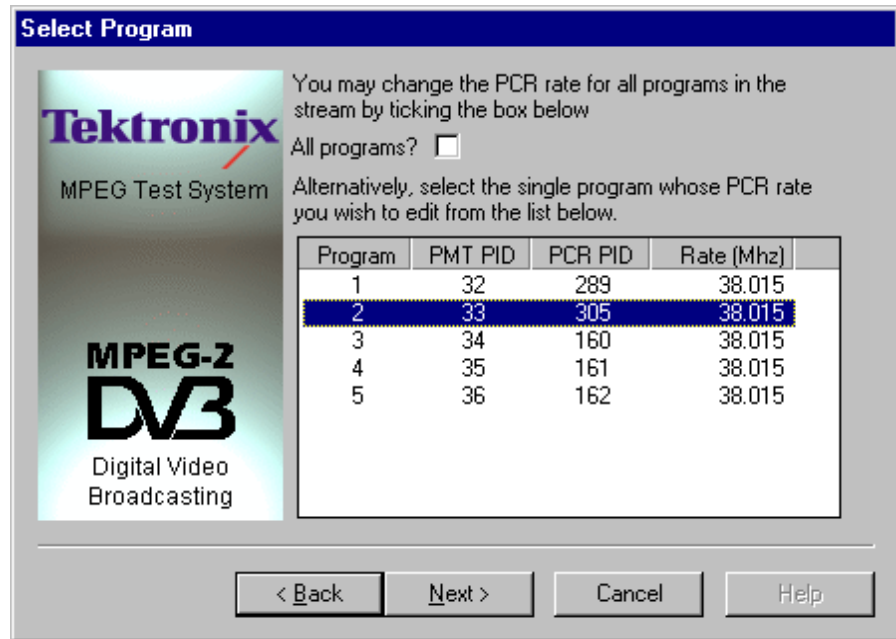

To recalculate the PCR rate for all the programs, check the All programs? option. Otherwise, select one of the programs from the list. Then select Next to move on to the Select New Rate page. The Back button moves back to the Introductory Page.

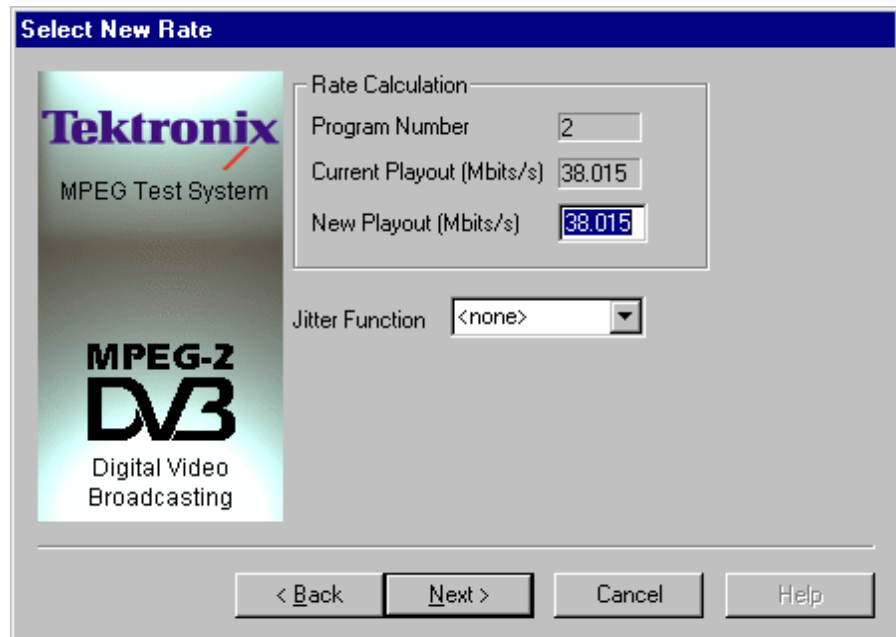

Keeping the rate as New Playout = Current Playout and selecting Jitter Function of <none>, will recalculate the PCR based on the current rate. This could be used, For example, to investigate a suspected problem with the PCR by playing the original and recalculated versions to see if there is a difference.

A new playout rate can be specified and/or a Jitter Function can be applied to the rate. There are seven Jitter Functions available including <none>. The available functions are:

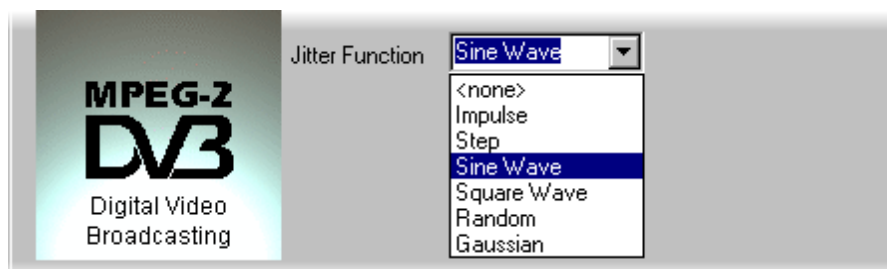

Each of the jitter functions is described in more detail at the end of this subsection.

If a Jitter Function is required, choose one of the six functions from the drop-down list, otherwise leave it set to <none>. Specify any change in the New Playout rate and select the Next button. Selecting Back returns to the Select program page.

When no Jitter function, (<none>), was selected, the Select Jitter Parameters page will not appear. Go on to the Summary page, which shows a picture of a checkered flag.

With a Jitter Function selected, the next page will be Select Jitter Parameters. This asks for additional information specific to the chosen Jitter Function. For example, the Sine Wave function requires the parameters shown in the following illustration.

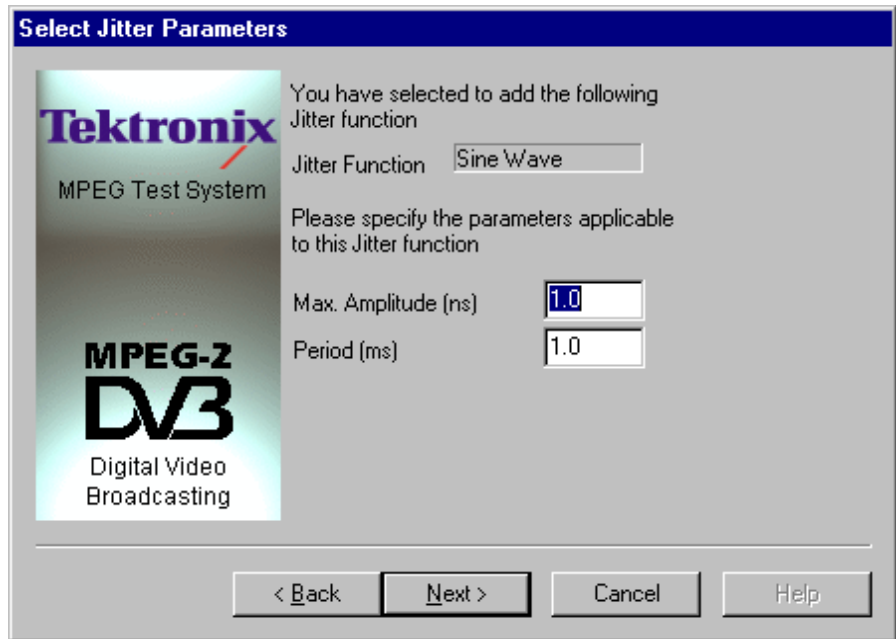

Specify the required parameters and select Next to move on to the Summary page. Use the Back button to return to the Select New rate page.

The Summary page displays a short list of the specified PCR rate changes.

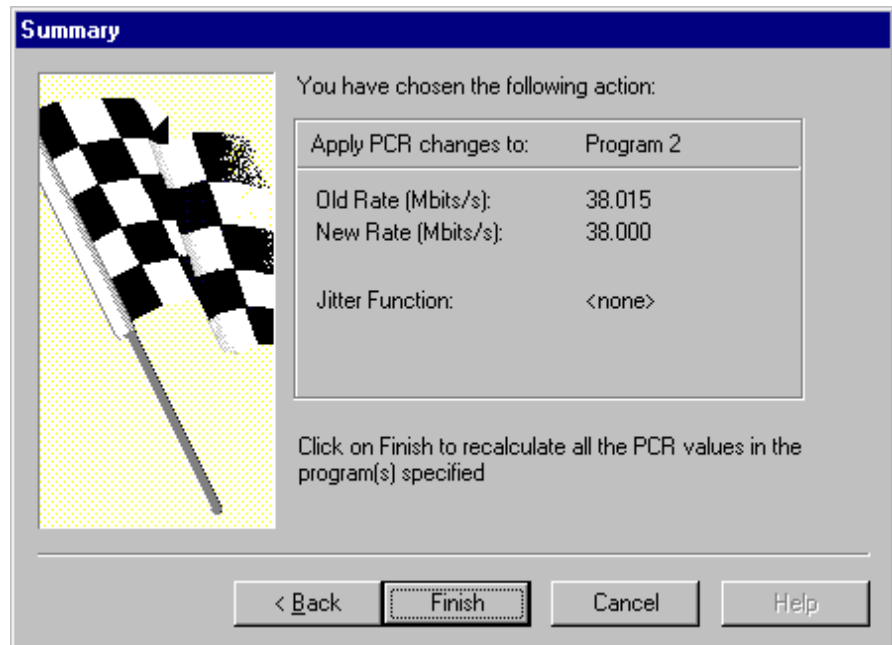

**NOTE.** Select Finish to recalculate the PCR values. Remember, once Finish has been selected, there is no going back.

---

Use the Back button to return to the previous pages to make any changes.

The program may take a while to perform the recalculations. The Summary page will stay on screen and the Hourglass mouse pointer be displayed while the wizard is processing. When the summary page disappears the calculation is complete and the file can be closed or edited.

## Jitter Functions

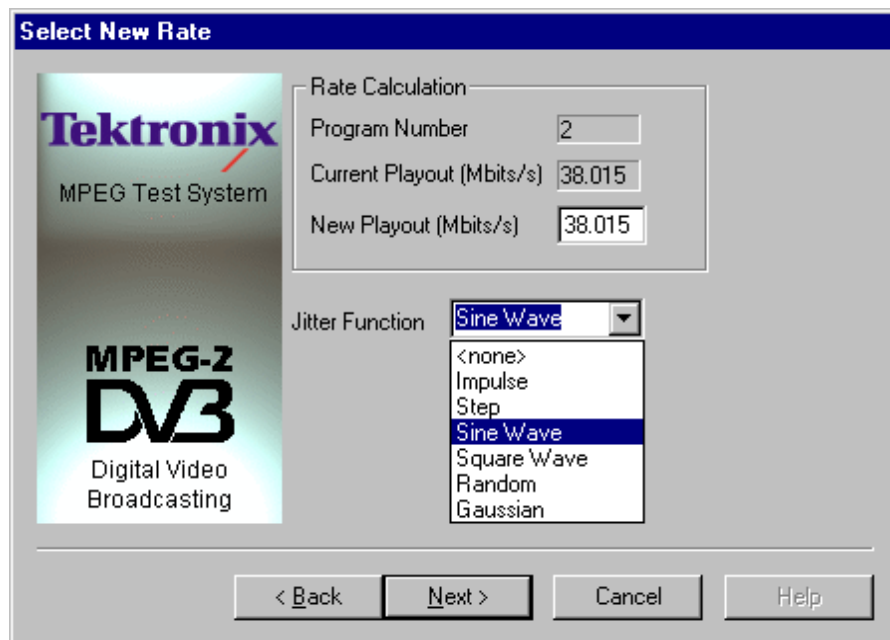

Select the required Jitter Function from the Select New rate page, then select Next to move on to the Select Jitter Parameters page to specify the parameters for the selected Jitter Function. The following subsections give details about each function.



**Impulse** The Impulse Jitter function adds a positive or negative value to a single PCR.

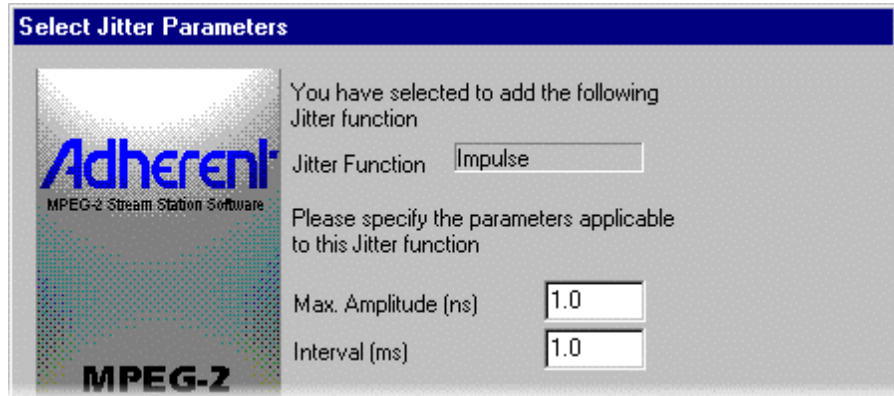

**Max Amplitude** Specifies the size of the impulse in nano-seconds. Type a minus sign in front of the value for a negative impulse.

**Interval** Specifies the time taken from the start of the file at which the Impulse is to be applied.

**Step** The Step Jitter Function adds a positive or negative offset to the ideal PCR values after a specified time. The offset will be the same for all PCRs.

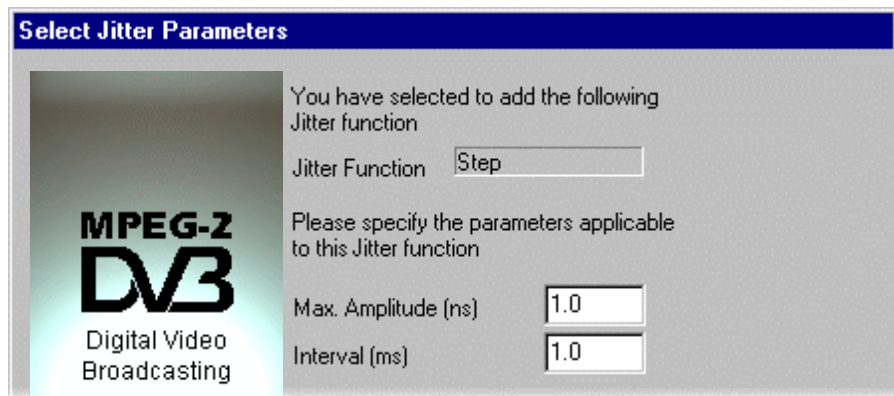

**Max Amplitude** Specifies the size of the offset in nano-seconds. Place a minus sign in front of the value for a negative offset.

**Interval** Specifies the time taken from the start of the file of the first PCR to which the offset is to be applied.

**Sine Wave** An offset that varies according to a sine function is applied to the ideal PCR value for each PCR.

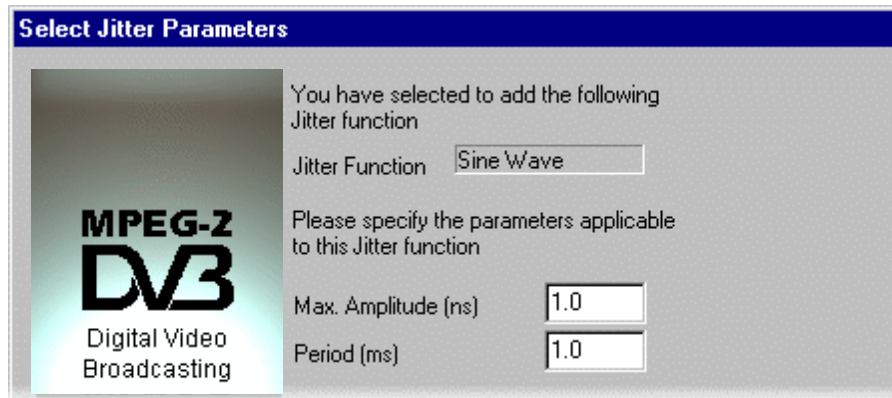

Max Amplitude Specifies the amplitude of the sine wave in nanoseconds.

Period Specifies the period of the sine wave in milliseconds.

**Square Wave** An offset, which varies according to a square wave function is applied to the ideal PCR value for each PCR. The square wave has an equal mark/space ratio.

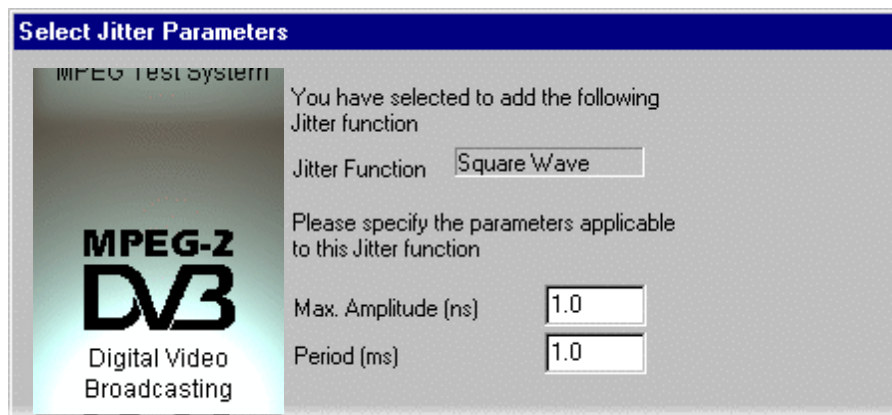

Max Amplitude Specifies the amplitude of the square wave in nanoseconds.

Period Specifies the period of the square wave in milliseconds.

**Random** The PCR jitter applies offsets of a uniform random distribution to the ideal values of the PCRs. Each offset will be within the range of  $\pm$  the specified amplitude.

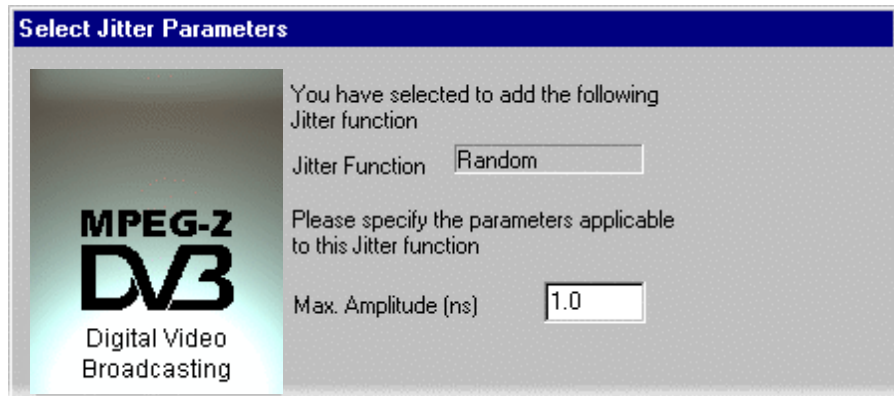

**Max Amplitude** Specifies the maximum amplitude of the jitter, relative to the ideal value, that can be added to any PCR. Only a positive value can be entered. The amplitude is always from -Max. Amplitude to +Max. Amplitude centered on the ideal PCR value.

**Gaussian** The offsets are applied to the ideal PCR values following a Gaussian distribution according to the specified standard deviation.

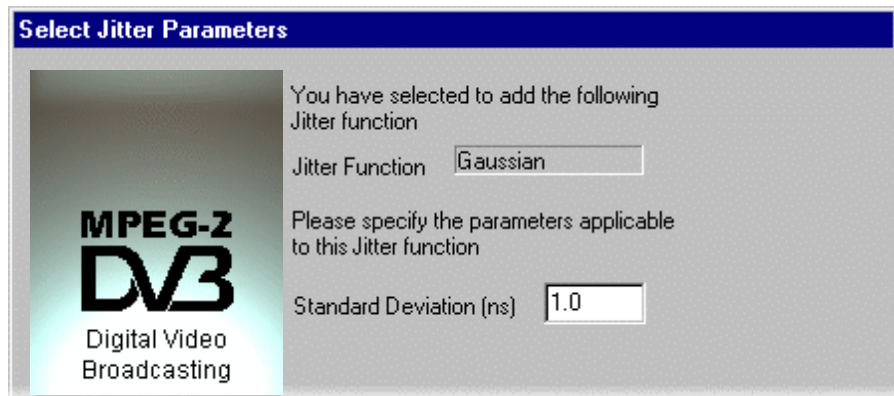

**Standard Deviation** Specifies the standard deviation to be used by the jitter function in deriving the offset for each PCR, relative to the ideal PCR value. Only a positive value can be entered for standard deviation.





# MPEG Player



# Table of Contents

<b>MPEG Player - Getting Started</b> .....	<b>10-1</b>
Display Elements .....	10-1
Hierarchical Display .....	10-8
<b>Menus and Controls</b> .....	<b>10-21</b>
Menus in the Play Screen .....	10-21
Menus in the Record Screen .....	10-50
Toolbar Buttons .....	10-55
<b>Reference</b> .....	<b>10-57</b>
Interface Card (SPI/ASI/310M Option) .....	10-57
Adding Jitter to PCRs .....	10-58
Using Preset Files .....	10-61
Using the Continuous Recording Feature .....	10-62
Performing Continuous Recording .....	10-64
Remote Commands .....	10-65

## List of Figures

<b>Figure 10-1: Elements of the Play screen</b> .....	<b>10-2</b>
<b>Figure 10-2: Play Status Indicator</b> .....	<b>10-3</b>
<b>Figure 10-3: Option Card Status bar</b> .....	<b>10-5</b>
<b>Figure 10-4: IP Status bar</b> .....	<b>10-6</b>
<b>Figure 10-5: Example of the hierarchical display</b> .....	<b>10-8</b>
<b>Figure 10-6: PCR Inaccuracy dialog box</b> .....	<b>10-19</b>
<b>Figure 10-7: Clock dialog box for Option Interface</b> .....	<b>10-24</b>
<b>Figure 10-8: Clock dialog box for IP interface</b> .....	<b>10-24</b>
<b>Figure 10-9: Default Clock Dialog box</b> .....	<b>10-27</b>
<b>Figure 10-10: PCR Initial Value dialog box</b> .....	<b>10-28</b>
<b>Figure 10-11: Start/Stop Position dialog box</b> .....	<b>10-29</b>
<b>Figure 10-12: Timer Play/Record dialog box</b> .....	<b>10-31</b>
<b>Figure 10-13: Others dialog box</b> .....	<b>10-32</b>
<b>Figure 10-14: TDT/TOT dialog box</b> .....	<b>10-33</b>
<b>Figure 10-15: ISDB/P-TS dialog box</b> .....	<b>10-34</b>
<b>Figure 10-16: Select Update Item dialog box</b> .....	<b>10-35</b>
<b>Figure 10-17: IP Playout Configuration dialog box</b> .....	<b>10-37</b>
<b>Figure 10-18: Advanced Protocol Settings dialog box</b> .....	<b>10-39</b>
<b>Figure 10-19: Stream Replication Settings dialog box</b> .....	<b>10-40</b>
<b>Figure 10-20: Parametric Settings dialog box</b> .....	<b>10-42</b>
<b>Figure 10-21: Error Insertion dialog box</b> .....	<b>10-43</b>
<b>Figure 10-22: Error Generation dialog box</b> .....	<b>10-44</b>
<b>Figure 10-23: Statistics dialog box without Stream Replication</b> ...	<b>10-45</b>
<b>Figure 10-24: Statistics dialog box with Stream Replication</b> .....	<b>10-46</b>
<b>Figure 10-25: Communication dialog box</b> .....	<b>10-47</b>
<b>Figure 10-26: PCR Inaccuracy dialog box</b> .....	<b>10-58</b>
<b>Figure 10-27: Jitter function with a sine jitter pattern applied</b> ....	<b>10-60</b>



## List of Tables

<b>Table 10-1: Icons used for MPEG-2, ARIB, DVB, and ATSC formats</b>	<b>10-9</b>
<b>Table 10-2: Icons specific to DVB format</b>	<b>10-12</b>
<b>Table 10-3: Icons specific to ARIB format</b>	<b>10-13</b>
<b>Table 10-4: Icons specific to ATSC format</b>	<b>10-15</b>
<b>Table 10-5: Icon text</b>	<b>10-16</b>
<b>Table 10-6: PCR Inaccuracy dialog box parameters</b>	<b>10-19</b>
<b>Table 10-7: File menu commands (Play screen)</b>	<b>10-21</b>
<b>Table 10-8: View menu commands (Play screen)</b>	<b>10-22</b>
<b>Table 10-9: Play menu commands (Play screen)</b>	<b>10-22</b>
<b>Table 10-10: SPI/ASI/310M menu commands (Play screen)</b>	<b>10-36</b>
<b>Table 10-11: IP menu commands</b>	<b>10-36</b>
<b>Table 10-12: Utility menu commands</b>	<b>10-47</b>
<b>Table 10-13: File menu commands (Record screen)</b>	<b>10-50</b>
<b>Table 10-14: Record menu commands</b>	<b>10-51</b>
<b>Table 10-15: SPI/ASI/310M menu command (Record screen)</b>	<b>10-55</b>
<b>Table 10-16: Toolbar button descriptions</b>	<b>10-55</b>



# MPEG Player - Getting Started

---

**NOTE.** This section describes the default MPEG Player installed in all MTS400 Series system.

The MTX100B MPEG Player is described in the MTX100B User Manual, Tektronix part number 071–1927–xx.

---

The MPEG Recorder & Player generates and captures MPEG–2 transport streams that are compliant with ATSC, DVB, and ARIB standards.

The MPEG Player provides the following features:

- Data rate: 213 Mbps maximum; 250 Kbps minimum.
- Hierarchical display of the stored or captured transport stream.
- 188, 204, 208 bytes packet size.
- Continuous recording of captured streams.
- PCR jitter insertion.
- Triggered stream capture.
- Full remote control using Ethernet interface.
- IP, ASI, SMPTE 310M and DVB SPI (DVB Parallel) interfaces available.
- Payout on one interface at a time, either IP or other interfaces.
- Stream replication (IP) with some attributes of the stream incremented by a certain value.

## Display Elements

There are two types of display screens to operate the MPEG Player; the Play screen and the Record screen.

- The Play screen is used to output the selected stream. When you open the application, this screen will display the last screen that was shown before closing.
- The Record screen is used to record the input stream. When you select **File > Record**, the screen switches to the Record screen.

This subsection explains the name and functions of the display elements in the Play or Record screen.

Figure 10–1 shows the location of display elements of the Play screen. The Record screen display elements are the same.

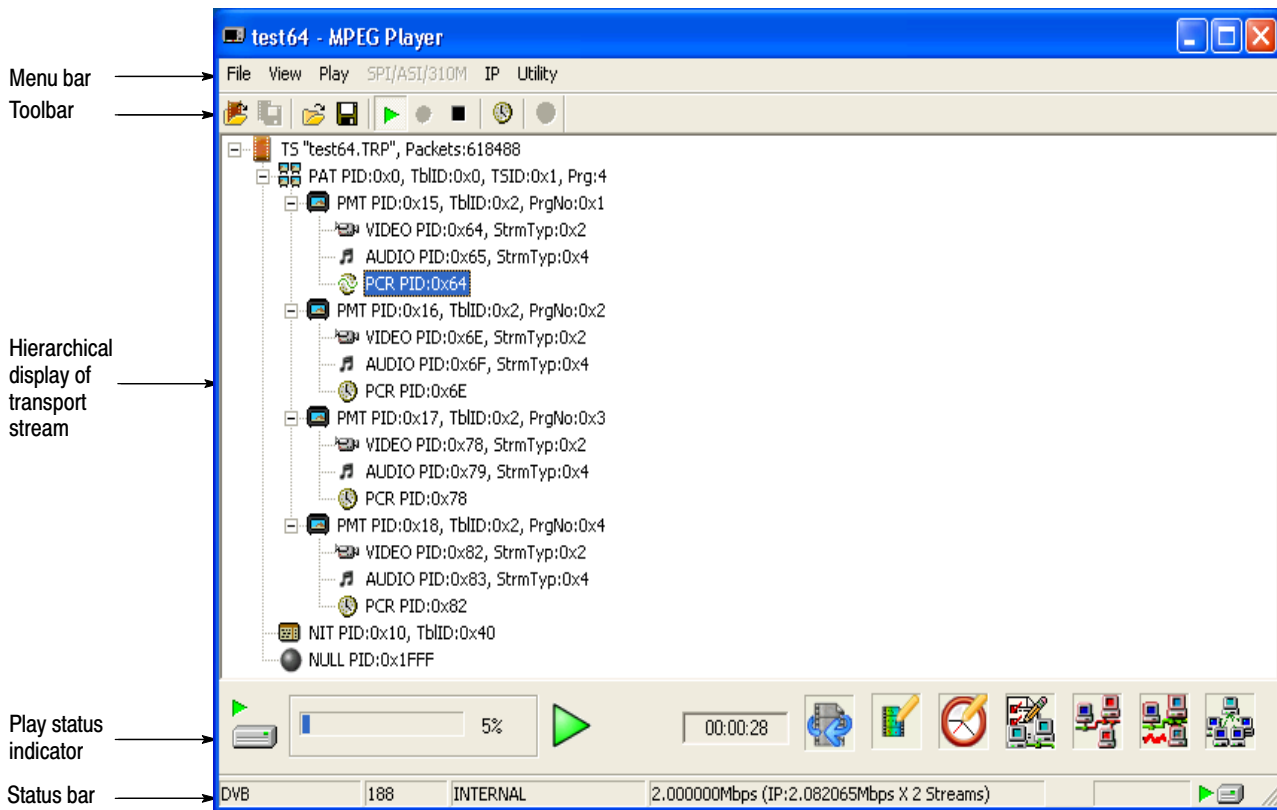

Figure 10–1: Elements of the Play screen

**Menu Bar** The Menu bar displays the names of the menus that can be used in the Play or Record screen.

Refer to *Menus and Controls* on page 10–21 for detailed information about the menus.

---

**NOTE.** The IP interface mode does not support the Record functionality and hence the Record option is disabled for IP.

---

**Toolbar** The toolbar provides shortcut buttons for many of the most often used menu commands. Click a toolbar button to select the corresponding command. You can toggle the toolbar display on and off using **Toolbar** command in the **View** menu.

Refer to *Toolbar Buttons* on page 10–55 for detailed information about the function of each toolbar button.

**Hierarchy Display** Each icon in the hierarchy display represents an element of the stream. The hierarchy text contains a description of the associated icon.

Refer to *Hierarchical Display* on page 10–8 for detailed information about the hierarchy icons.

**Play/Record Status Indicator** The Play Status indicator (see Figure 10–2) is displayed while the selected stream is being output. It shows the output status of the selected stream: the progress of the stream output, the output source, the operational status, and the elapsed time.

The Record Status indicator is displayed while the input stream is being recorded. It shows the record status of the input stream: the progress of the stream record, the record target, and the elapsed time.

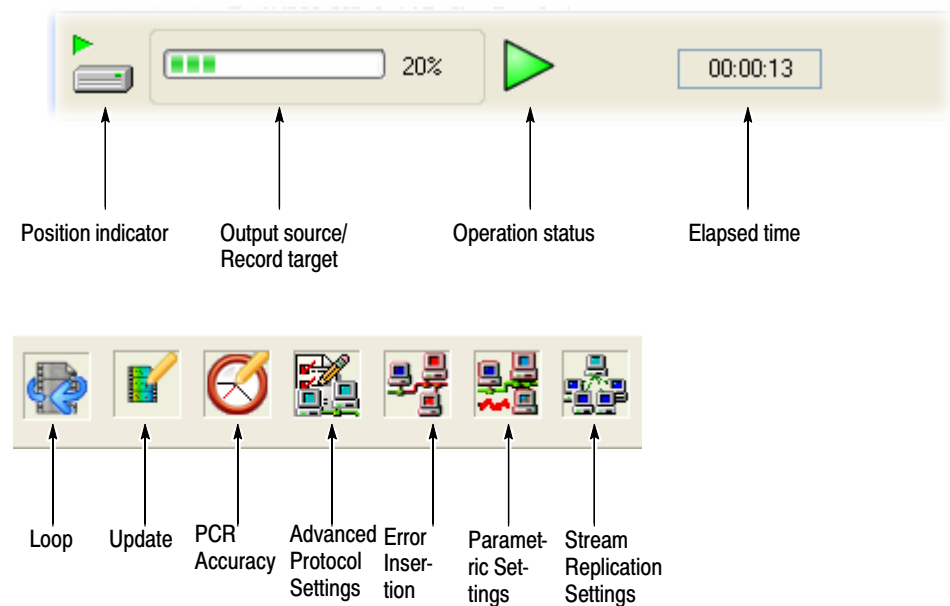

**Figure 10–2: Play Status Indicator**

The Play/Record Status indicator shows the following information:

**Position Indicator**

In the Play screen, this indicator shows the progress of stream output using the duration gauge. In the Record screen, this indicator shows the progress of stream record using the duration gauge.

The duration gauge is updated every second. If you output a stream with a repetition rate of approximately three seconds, the gauge may not be displayed correctly.

**Output Source/Record Target.**

In the Play screen, this indicator shows the output source used to output the selected stream. In the Record screen, this indicator shows the record target that is used to record the input stream.

One of each set of icons is displayed, depending on the selections and status. The icons and their meanings are as follows:



The hard disk is being used for the output source or record target.



The RAM is being used for the output source or record target.

**Operation Status**

Shows the current operation status of the instrument.

In the Play screen, the icons and meanings are as follows:



The selected stream is being output.



The selected stream is being read from the hard disk to the RAM.

In the Record screen, the icons and meanings are as follows:



(Red)

The captured stream is being recorded.



(Red)

The stream record is stopped.



(Yellow)

The Player is waiting for a trigger event.



(Red)

A trigger event has occurred.



The captured stream is being processed on the hard disk.



The captured stream is being saved from the RAM to the hard disk.

**Elapsed Time**

In the Play screen, this box displays the elapsed time of the current stream data output.

In the Record screen, this box displays the elapsed time since the input stream started recording.



In the Play screen, this icon indicates that the stream is continuously output using the loop method.



In the Play screen, this icon indicates that the stream parameters are updated.



In the Play screen, this icon indicates that the PCR accuracy is enabled.



In the Play screen, this icon indicates that the Advanced Protocol Settings is enabled and applied to the stream.



In the Play screen, this icon indicates that the errors are inserted in the stream.



In the Play screen, this icon indicates that the parametric settings are enabled and applied to the stream.



In the Play screen, this icon indicates that the Stream replication settings are enabled and applied to the stream.

**Status Bar**

The Option Status bar (see Figure 10–3) and the IP Status bar (see Figure 10–4) contains several indicators that display general information about the transport stream output or record status.

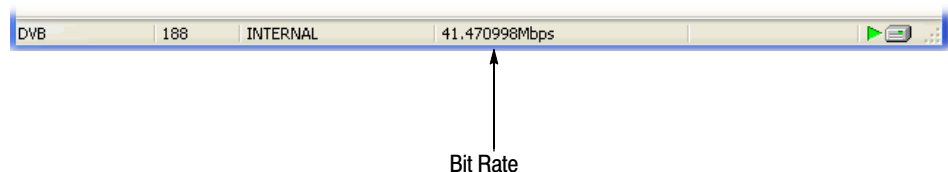

**Figure 10–3: Option Card Status bar**

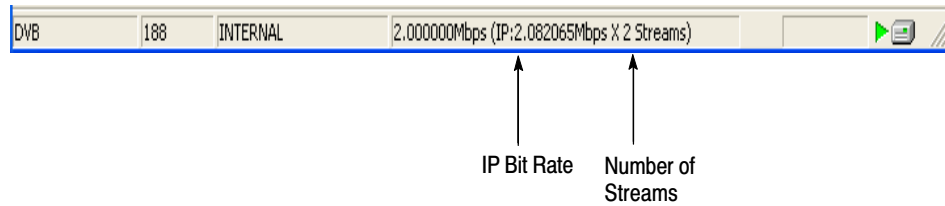

**Figure 10-4: IP Status bar**

From left to right, the Status bar shows the following information:

<b>Standard</b>	In the Play screen, this indicator shows the standard used to display the selected stream (MPEG2, ARIB, DVB, ATSC, S-TMCC, M-TMCC, or Non TS). In the Record screen, this indicator shows the standard used to display the input stream.
<b>Packet Size</b>	In the Play screen, this indicator displays the packet size in bytes (188, 204, 208 or Non TS) of the stream output. In the Record screen, this indicator displays the packet size in bytes of the input stream.
<b>Clock Source</b>	This indicator displays the source of the reference clock (internal or external) used for the stream output.
<b>Bit Rate</b>	In the Play screen when the SPI/ASI/310M option is selected, this indicator shown in Figure 10-3 displays the bit rate (Mbps) of the stream output. In the Record screen, this indicator displays the bit rate (Mbps) of the input stream.
<b>IP Bit Rate</b>	In the Play screen when the IP interface option is selected, this indicator shown in Figure 10-4 displays the bit rate (Mbps) of the IP stream output. The Record screen is disabled for the IP interface option.
<b>Number of Streams</b>	In the Play screen when the IP interface option with Stream Replication Settings is selected, this indicator shown in Figure 10-4 displays the number of replicated streams.
<b>RAM free space</b>	In the Play screen, this indicator shows the RAM free space that can be used to output the selected stream. In the Record screen, this indicator shows the RAM free space that can be used to record the input stream.



### Output Source/Record Target

In the Play screen, this indicator shows the output source used to output the selected stream. In the Record screen, this indicator shows the record target used to record the input stream.

This indicator is the same as the output source/record target indicator of the Play/Record Status indicator.

### Remote Connection Status Icons

The remote connection status icons appear when a TCP/IP connection for remote control is established. The right icon shows the status of the TCP/IP connection (this icon is always displayed when the TCP/IP connection is established), and the left icon shows the lock status of the front-panel buttons and mouse input.

There are two display states:



This shows that the TCP/IP connection for remote control is established.



This shows that the TCP/IP connection for remote control is established and the front-panel buttons and mouse input are locked by the :SYSTem:KLOCK:STATe ON command.

To reset the lock status, select the ESC key (or send the :SYSTem:KLOCK:STATe OFF command).

When the TCP/IP connection is closed, the remote status icons disappear.

## Hierarchical Display

The MPEG Player displays the selected transport stream using a hierarchical structure. This section describes the hierarchical display and defines each icon you may encounter in the display.

The MPEG Player uses icons displayed in a hierarchical structure to show the interrelationship of transport stream components (Figure 10–5). Additional information about each stream component such as PID and Table ID numbers is displayed next to each icon.

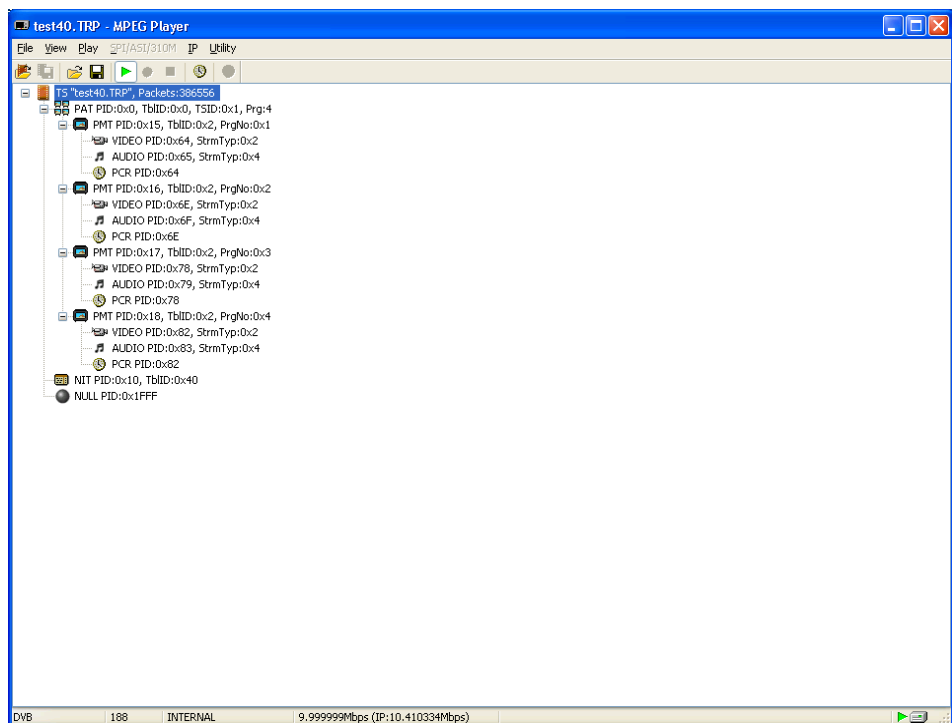

**Figure 10–5: Example of the hierarchical display**

The '+' symbol displayed to the left of some icons indicates that the item includes lower-level transport stream components that are not displayed. The symbol changes to '-' when the lower level components are displayed. To expand the hierarchy, click on the '+' symbol. Similarly, to collapse the hierarchy, click on the '-' of the selected upper-level icon.

When a transport stream contains more items than what will be displayed on the screen at a time, a scroll bar appears at the right of the screen.

Click an element in the hierarchy to select (and highlight) it.

## Hierarchical Display Icons

Table 10–1 describes the icons you may encounter in the hierarchical display of the MPEG Player for transport streams using the MPEG-2, ARIB, DVB and ATSC formats.







Table 10–2 describes icons that are specific to transport streams using DVB format.

Table 10–3 describes icons that are specific to transport streams using ARIB format.



Table 10–4 describes icons that are specific to transport streams using the ATSC format.

Refer to *Icon Text and Dialog Box* on page 10–16 for descriptions of the icon text and dialog box associated with the hierarchy icon.







**Table 10–1: Icons used for MPEG-2, ARIB, DVB, and ATSC formats**

Icon	Element type
	ISDB-T Broadcast transport stream that is defined ARIB STD-B31.
	S-TMCC Transport stream to which TMCC information is inserted into 8 bytes in its Reed-Solomon area (16 bytes).
	M-TMCC Transport stream to which TMCC information is inserted into its sync byte area, and having super frame structure.
	Non TS Data stream other than transport stream format.
	Transport Stream (TS) This icon represents all transport stream packets that make up the stream.
	Program Association Table (PAT) One or more transport packets with a PID value and table_id value of 0x00.
	Transport Stream Description Table (TSDT) One or more transport packets with a PID value of 0x02 and a table_id value of 0x03.
	Network Information Table (NIT) One or more transport packets with a PID value specified by the network_PID in the PAT.
	Conditional Access Table (CAT) One or more transport packets with a PID value of 0x01 and a table_id value of 0x0001.



**Table 10-1: Icons used for MPEG-2, ARIB, DVB, and ATSC formats (Cont.)**

Icon	Element type
	<p>Program Map Table (PMT)</p> <p>One or more transport packets with a PID value specified by the program_map_PID in the PAT and a table_id value of 0x02.</p>
	<p>Program Clock Reference (PCR)</p> <p>One or more transport packets with a PID value specified by the PCR_PID in the PMT and a PCR_flag value of 1.</p>
	<p>Video elementary stream</p> <p>One or more transport packets with a PID value specified by the elementary_PID in the PMT and a stream_type value of 0x01, 0x02, or 0x10.</p>
	<p>A lock symbol appears in the icon when the transport_scrambling_control value is set to 01.</p>
	<p>Audio elementary stream</p> <p>One or more transport packets with a PID value specified by the elementary_PID in the PMT and a stream_type value of 0x03, 0x04, or 0x11.</p>
	<p>A lock symbol appears in the icon when the transport_scrambling_control value is set to 01.</p>
	<p>Audio AAC, Audio AC3 (ATSC format)</p> <p>One or more transport packets with a PID value specified by the elementary_PID in the PMT and a stream_type value of 0x0F or 0x81 (ATSC format).</p>
	<p>A lock symbol appears in the icon when the transport_scrambling_control value is set to 01.</p>
	<p>Data stream</p> <p>One or more transport packets with a PID value specified by the elementary_PID in the PMT and a stream_type value of other than 0x01 to 0x05, 0x08, and 0x0F (in ATSC format, 0x81).</p>
	<p>A lock symbol appears in the icon when the transport_scrambling_control value is set to 01.</p>
	<p>Private Section</p> <p>One or more transport packets with a PID value specified by the elementary_PID in the PMT and a stream_type value of 0x05.</p>
	<p>A lock symbol appears in the icon when the transport_scrambling_control value is set to 01.</p>
	<p>Digital Storage Media Command and Control (DSM-CC)</p> <p>One or more transport packets with a PID value specified by the elementary_PID in the PMT and a stream_type value of 0x08.</p>
	<p>A lock symbol appears in the icon when the transport_scrambling_control value is set to 01.</p>



**Table 10-1: Icons used for MPEG-2, ARIB, DVB, and ATSC formats (Cont.)**

Icon	Element type
	Entitlement Control Message (ECM) One or more transport packets with a PID value specified by the CA_PID of the CA_descriptor in the PMT, a payload_start_unit_indicator value of 1, and the payload does not start 000001 (section) or the payload starts 000001 (PES).
	Entitlement Management Message (EMM) One or more transport packets with a PID value specified by the CA_PID of the CA_descriptor in the CAT, a payload_start_unit_indicator value of 1, and the payload does not start 000001 (section) or the payload starts 000001 (PES).
	GHOST One or more transport packets with a PID value not specified in the PSI or Private Section PID file when the transport stream is downloaded.
	NULL One or more transport packets with a PID value of 0x1FFF.
	GARBAGE One or more transport packets in the section-data structure at the beginning of the section are not complete.
	Adaptation Field Error (ADFERR) One or more transport packets with an adaptation_field_control value of 0x00.

**Table 10-2: Icons specific to DVB format**

Icon	Element type
	Service Description Table (SDT) One or more transport packets with a PID value of 0x0011 and a table_id value of 0x42.
	Bouquet Association Table (BAT) One or more transport packets with a PID value of 0x0011 and a table_id value of 0x4A.
	Event Information Table (EIT) One or more transport packets with a PID value of 0x0012 and a table_id value of 0x4E-0x6F.
	Running Status Table (RST) One or more transport packets with a PID value of 0x0013 and a table_id value of 0x4E-0x71.
	Stuffing Table (ST) One or more transport packets with a PID value of 0x0010-0x0013 and a table_id value of 0x72.
	Discontinuity Information Table (DIT) One or more transport packets with a PID value of 0x1E and a table_id value of 0x7E.
	Selection Information Table (SIT) One or more transport packets with a PID value of 0x1F and a table_id value of 0x7F.
	Time and Data Table (TDT) One or more transport packets with a PID value of 0x0014 and a table_id value of 0x72.
	Time Offset Table (TOT) One or more transport packets with a PID value of 0x0014 and a table_id value of 0x73.

**Table 10–3: Icons specific to ARIB format**



Icon	Element type
	Service Description Table (SDT) One or more transport packets with a PID value of 0x0011 and a table_id value of 0x42.
	Bouquet Association Table (BAT) One or more transport packets with a PID value of 0x0011 and a table_id value of 0x4A.
	Event Information Table (EIT) One or more transport packets with a PID value of 0x0012 and a table_id value of 0x4E-0x6F.
	Running Status Table (RST) One or more transport packets with a PID value of 0x0013 and a table_id value of 0x4E-0x71.
	Stuffing Table (ST) One or more transport packets with a PID value of 0x0010-0x0013 and a table_id value of 0x72.
	Discontinuity Information Table (DIT) One or more transport packets with a PID value of 0x1E and a table_id value of 0x7E.
	Selection Information Table (SIT) One or more transport packets with a PID value of 0x1F and a table_id value of 0x7F.
	Local event Information Table (LIT) One or more transport packets with a PID value of 0x0020 and a table_id value of 0xD0. One or more transport packets with a PID value specified by the elementary_PID in the PMT and a table_id value of 0xD0 when a stream type value is 0x05.
	Event Relation Table (ERT) One or more transport packets with a PID value of 0x0021 and a table_id value of 0xD1. One or more transport packets with a PID value specified by the elementary_PID in the PMT and a table_id value of 0xD1 when a stream type value is 0x05.
	Index Transmission Table (ITT) One or more transport packets with a PID value specified by the elementary_PID in the PMT and a table_id value of 0xD2.
	Partial Content Announcement Table (PCAT) One or more transport packets with a PID value of 0x22 and a table_id value of 0xC2.
	Software Download Trigger Table (SDTT) One or more transport packets with a PID value of 0x23 and a table_id value of 0xC3.

**Table 10-3: Icons specific to ARIB format (Cont.)**

Icon	Element type
	Download Control Table (DCT) One or more transport packets with a PID value of 0x17 and a table_id value of 0xC0.
	DownLoad Table (DLT) One or more transport packets with a PID value specified by the DL_PID in the DCT and a stream_type value of 0xC1. A lock symbol appears in the icon when the transport_scrambling_control value is set to 01.
	Broadcaster Information Table (BIT) One or more transport packets with a PID value of 0x24 and a table_id value of 0xC4.
	Network Board Information Table (NBIT) One or more transport packets with a PID value of 0x25 and a table_id value of 0xC5 or 0xC6.
	Linked Description Table (LDT) One or more transport packets with a PID value of 0x25 and a table_id value of 0xC7.
	Time and Data Table (TDT) One or more transport packets with a PID value of 0x0014 and a table_id value of 0x72.
	Time Offset Table (TOT) One or more transport packets with a PID value of 0x0014 and a table_id value of 0x73.



**Table 10–4: Icons specific to ATSC format**

Icon	Element type
	Master Guide Table (MGT) One or more transport packets with a PID value of 0x1FFB and a table_id value of 0xC7.
	Terrestrial Virtual Channel Table (TVCT) One or more transport packets with a PID value of 0x1FFB and a table_id value of 0xC8.
	Cable Virtual Channel Table (CVCT) One or more transport packets with a PID value of 0x1FFB and a table_id value of 0xC9.
	Rating Region Table (RRT) One or more transport packets with a PID value of 0x1FFB and a table_id value of 0xCA.
	Event Information Table (EIT) One or more transport packets with a PID value specified by the table_type_PID in the MGT and a table_id value of 0xCB.
	Channel Extended Text Table (CETT) One or more transport packets with a PID value of 0x1FFB and a table_id value of 0xC8.
	Event Extended Text Table (EETT) One or more transport packets with a PID value of 0x1FFB and a table_id value of 0xC9.
	Program Identifier Table (PIT) One or more transport packets with a PID value specified by the elementary_PID in the PMT and a table_id value of 0xD0 when a stream_type value is 0x85.
	System Time Table (STT) One or more transport packets with a PID value of 0x1FFB and a table_id value of 0xCD.

**Icon Text and Dialog Box**

To the right of each icon, the MPEG Player displays text that describes each transport stream component. In addition, for the PCR icon, you can display a dialog box to change the parameters for the component. Table 10–5 shows the text that will be displayed with each icon.

**Table 10-5: Icon text**

Component	Text
ISDB-T Icon	<p>“xxx.rmx”: Shows the file name.</p> <p>Packets: Shows the total number of packets in the broadcast transport stream.</p>
S-TMCC Icon	<p>“xxx.trp”: Shows the file name.</p> <p>TC8PSK/xx, BPSK/xx, or QPSK/xx: Shows the modulation system and the number of contract slots (xx).</p>
M-TMCC Icon	<p>“xxx.trp”: Shows the file name.</p> <p>SF: Shows the number of super frames.</p>
Non TS Icon	<p>“xxx.xx”: Shows the file name.</p> <p>FileSize: Shows the file size in byte.</p>
Transport Stream (TS) Icon	<p>“xxx.trp”: Shows the file name of the transport stream.</p> <p>Packets: Shows the total number of packets in the transport stream.</p> <p>When this icon is used with the S-TMCC or M-TMCC icon, the following text information is displayed:</p> <p>TSID: Shows the ID number for the transport stream.</p> <p>TC8PSK/xx, BPSK/xx, or QPSK/xx: Shows the modulation system and the number of contract slots (xx).</p>
Program Allocation Table (PAT) Icon	<p>PID: Shows the PID value of the PAT.</p> <p>TblID: Shows the table_id value of the PAT.</p> <p>TSID: Shows the transport_stream_id value of the PAT.</p> <p>Prg: Shows the number of programs contained in the transport stream.</p>
Transport Stream Description Table (TSDT) Icon	<p>PID: Shows the PID value of the TSDT.</p> <p>TblID: Shows the table_id value of the TSDT.</p>
Network Information Table (NIT) Icon	<p>PID: Shows the PID value of the NIT.</p> <p>TblID: Shows the table_id value of the NIT.</p>

**Table 10–5: Icon text (Cont.)**

<b>Component</b>	<b>Text</b>
Conditional Access Table (CAT) Icon	PID: Shows the PID value of the CAT. TbIID: Shows the table_id value of the CAT.
Program Map Table (PMT) Icon	PID: Shows the PID value of the PMT. TbIID: Shows the table_id value of the PMT. PrgNo: Shows the program number associated with the PMT.
Program Clock Reference (PCR) Icon	PID: Shows the PID value of the PCR. See also <i>PCR Inaccuracy Dialog Box</i> , page 10–19.
Video Elementary Stream (VIDEO) Icon	PID: Shows the PID value of the video elementary stream. StrmTyp: Shows the type of the video elementary stream (0x01 or 0x02).
Audio Elementary Stream (AUDIO) Icon	PID: Shows the PID value of the audio elementary stream. StrmTyp: Shows the type of the audio elementary stream (0X03 or 0X04).
AUDIO_AAC and AUDIO_AC3 Icons	PID: Shows the PID value of the audio elementary stream. StrmTyp: Shows the type of the audio elementary stream (0X0F or 0x81).
Data Stream (DATA) Icon	PID: Shows the PID value of the data stream. StrmTyp: Shows the type of the data stream.
Private Section (DATA_SECT) Icon	PID: Shows the PID value of the private section. TbIID: Shows the table_id value of the private section. StrmTyp: Shows the type of the private section.
DSM_CC Icon	PID: Shows the PID value of the data DSM-CC. StrmTyp: Shows the type of the DSM-CC.
Entitlement Control Message (ECM) Icon	PID: Shows the PID value of the ECM. TbIID: Shows the table_id value of the ECM.
Entitlement Management Message (EMM) Icon	PID: Shows the PID value of the EMM. TbIID: Shows the table_id value of the EMM.
GHOST Icon	PID: Shows the PID value of the GHOST.
Adaptation Field Error (ADFERR) Icon	PID: Shows the PID value of the ADFERR.

**Table 10-5: Icon text (Cont.)**

<b>Component</b>	<b>Text</b>
NULL Icon	PID: Shows the PID value of the NULL.
GARBAGE Icon	PID: Shows the PID value of the GARBAGE.
SDT, BAT, EIT, RST, ST, DIT, SIT, LIT, ERT, ITT, PCAT, SDTT, DCT, DLT, BIT, NBIT, and LDT Icons	<p>PID: Shows the PID value of the SDT, BAT, EIT, RST, ST, DIT, SIT, LIT, ERT, ITT, PCAT, SDTT, DCT, DLT, BIT, NBIT, or LDT.</p> <p>TbIID: Shows the table_id value of the SDT, BAT, EIT, RST, ST, DIT, SIT, LIT, ERT, ITT, PCAT, SDTT, DCT, DLT, BIT, NBIT, or LDT.</p>
TDT and TOT Icon	<p>PID: Shows the PID value of the TDT or TOT.</p> <p>TbIID: Shows the table_id value of the TDT or TOT.</p>
MGT and PIT Icons	<p>PID: Shows the PID value of the MGT or PIT.</p> <p>TbIID: Shows the table_id value of the MGT or PIT.</p>
TVCT, CVCT, RRT, EIT, CETT, and EETT Icons	<p>PID: Shows the PID value of the TVCT, CVCT, RRT, EIT, CETT, or EETT.</p> <p>TbIID: Shows the table_id value of the TVCT, CVCT, RRT, EIT, CETT, or EETT.</p> <p>TbType: Shows the table_type value of the TVCT, CVCT, RRT, EIT, CETT, or EETT.</p>
System Time Table (STT) Icon	<p>PID: Shows the PID value of the STT.</p> <p>TbIID: Shows the table_id value of the STT.</p>

**PCR Inaccuracy Dialog Box.** If you press the SELECT button when the PCR icon is selected, the PCR Inaccuracy dialog box appears as shown in Figure 10–6. This dialog box allows you to add jitter to the `program_clock_reference_base` value and the `program_clock_reference_extension` value.

Refer to *Adding Jitter to PCRs* on page 10–58 for more information.

Table 10–6 describes the PCR Inaccuracy dialog box parameters.

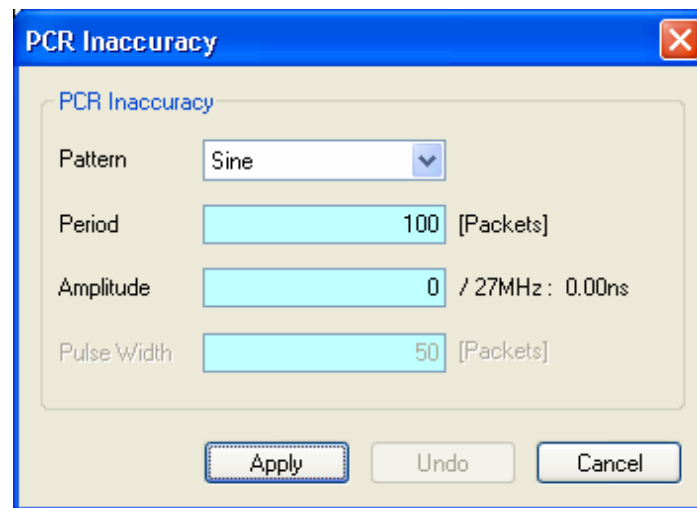

**Figure 10–6: PCR Inaccuracy dialog box**

**Table 10–6: PCR Inaccuracy dialog box parameters**

Parameter	Description
Pattern	Selects the waveform type of the waveform used to add jitter. You can select Sine, Square, Triangle, Pulse, Sawtooth, Random, or Offset.
Period	Sets the period of the waveform used to add jitter. You can set the value from 5 to 3000 packets in 1 packet steps.
Amplitude	Sets the amplitude of the waveform used to add jitter. You can set the value from 0/27 MHz to 135000000/27 MHz (0 s to 5 s).
Pulse Width	Sets the pulse width of the waveform used to add jitter. You can set the value from 1 to (period - 1) packet(s) in 1 packet steps. This Pulse Width parameter is available only when the Pattern parameter is set to Pulse.



# Menus and Controls

This section describes the function of each selection available in the menus. This section is divided into the following subsections:

- *Menus in the Play Screen* describes all of the menu commands and their features available in the Play screen.
- *Menus in the Record Screen* describes all of the menu commands and their features available in the Record screen.
- *Toolbar Buttons* describes the toolbar buttons and their functions.

## Menus in the Play Screen

This subsection describes the menus in the Play screen.

**File Menu** The File menu in the Play screen contains commands for selecting a stream file and for loading and saving a preset file. Table 10–7 describes the commands in the File menu.

**Table 10–7: File menu commands (Play screen)**

Command	Description
Open	Opens a stream file stored in the E: drive (volume E). When a file is selected, the MPEG Player checks the packet size of the file. When it is a transport stream file, its data is output in packets. Therefore, if an incomplete packet is included at the start or end point of the file, the portion is not output.  The function uses a standard Windows Open... dialog box.
Load Preset	Loads the specified preset file (*.set). When a preset file is loaded, the current instrument settings are changed by the file's content. Refer to <i>Preset File</i> , page 10–61, for more information about the preset file.
Save Preset	Saves the current instrument settings as a preset file. Refer to <i>Preset File</i> , page 10–61, for more information about the preset file.
RECORD	When the SPI/ASI/310M interface is selected the Play screen switches to the Record screen. The Record screen is disabled for IP interface.
Exit	Quits the MPEG Player application. The MPEG Player application settings are saved.

**View Menu** The View menu contains commands that control the display of the Toolbar and Status bar. Table 10–8 describes the commands available in the View menu.

**Table 10–8: View menu commands (Play screen)**

Command	Description
Toolbar	Shows or hides the toolbar in the Play screen.
Status Bar	Shows or hides the status bar in the Play screen.

**Play Menu** The Play menu contains commands for defining output parameters, such as packet size, output clock rate, and output source. Table 10–9 describes the commands available in the Play menu.

**Table 10–9: Play menu commands (Play screen)**

Command	Description
Interface	Sets the interface to transmit and receive ethernet packets. You can select either IP or SPI/ASI/310M interfaces.
Packet Size	<p>Sets the packet size (in bytes) for the stream. You can set the packet size to 188 (188 + 0), 204 (188 + 16), 208 (188 + 20) bytes, or Non TS.</p> <p>These packet sizes can only be set for an MPEG2 transport stream. For an S-TMCC or M-TMCC transport stream, the packet size is fixed to 204. For a Non TS stream, the packet size is fixed to Non TS. In addition, if you select 8VSB, the packet size is fixed to 188.</p> <p>When you select Non TS, the MPEG Player deals with stream data in a byte unit (not a packet unit) and outputs all of the data in a file. If a transport stream contains any error, you can output it by selecting Non TS.</p>
Clock	Sets the clock rate of the stream output. When you select this command, the Clock dialog box appears. Refer to <i>Clock Dialog Box</i> on page 10–24 for more information.
Update	<p>Sets whether to update parameters in the stream when looped. You can select On or Off. You cannot set to On for a Non TS stream.</p> <p>You can select which parameters in the stream are updated using the Others dialog box. Refer to <i>Others Dialog Box</i> on page 10–32 for more information.</p>



**Table 10–9: Play menu commands (Play screen) (Cont.)**

Command	Description
Sync	<p>Sets the format of the PSYNC signal output from the SPI IN/OUT connector. You can select TS Packet, SF, or Non TS. For TS Packet, a single pulse signal is output at the start point of each packet. For SF, a single pulse is output at the start point of the SF appearing every 204 X 48 X 8 bytes. For Non TS, the Set Non-TS Sync dialog box appears, where you can enable the PSYNC and DVALID signals.</p> <p>Refer to <i>Set Non-TS Sync Dialog Box</i> on page 10–28 for more information.</p>
PCR Initial Value	<p>Sets the initial value of the program_clock_reference_base and program_clock_reference_extension parameters when the transport stream is output.</p> <p>When you select this command, the PCR Initial Value dialog box appears. Refer to <i>PCR Initial Value Dialog Box</i> on page 10–28 for more information.</p>
Source	<p>Selects the source for stream output. You can select RAM or Disk.</p> <p>Refer to <i>SPI/ASI/310M Interface Menu - Play</i> on page 10–36 and <i>IP Interface Menu</i> on page 10–36 for detailed information about differences between the two sources.</p>
Loop	<p>Sets whether or not the stream is output using looping method. You can select On or Off. If you set it to On, the selected stream is continuously output. If you set it to Off, the selected stream is output once.</p>
Start/Stop	<p>Sets the start and stop position of the stream, and initial start position of the stream for loop output.</p> <p>When you select this command, the Start/Stop Position dialog box appears. Refer to <i>Start/Stop Position Dialog Box</i> on page 10–29 for more information.</p>
Auto play	<p>Sets whether or not the transport stream is automatically output using the last power-down settings when you turn the MPEG Player on. You can select On or Off. If you set it to On, take care of the output level setting used when the MPEG Player was last turned off and the input level of the instrument (device) currently connected to the MPEG Player.</p>
Timer Play	<p>Sets the date and time used to output a stream automatically.</p> <p>When you select this command, the Timer Play/Record dialog box appears. Refer to <i>Timer Play/Record Dialog Box</i> on page 10–31 for more information.</p>
Other	<p>Sets the standard used to display the selected stream and display radix for the text information.</p> <p>When you select this command, the Others dialog box appears. Refer to <i>Others Dialog Box</i> on page 10–32 for more information.</p>

**Clock Dialog Box.** When you select the **Clock...** command from the Play menu, the Clock dialog box is displayed.

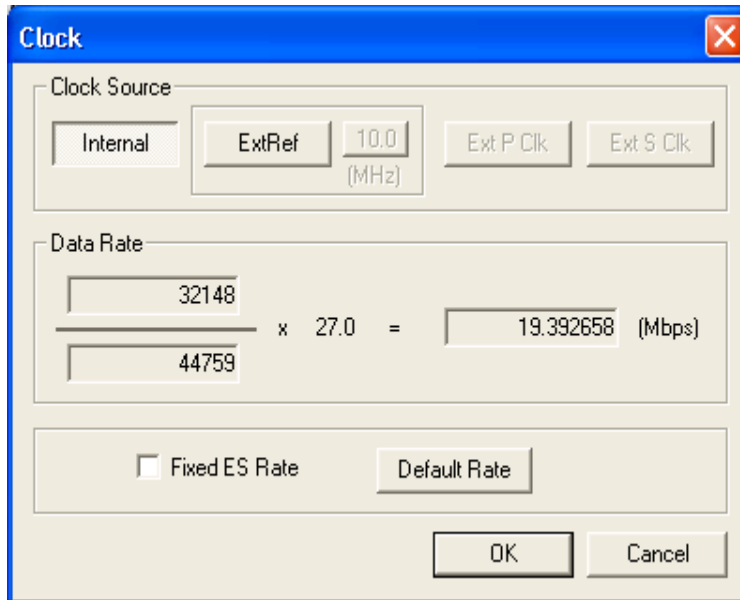

**Figure 10-7: Clock dialog box for Option Interface**

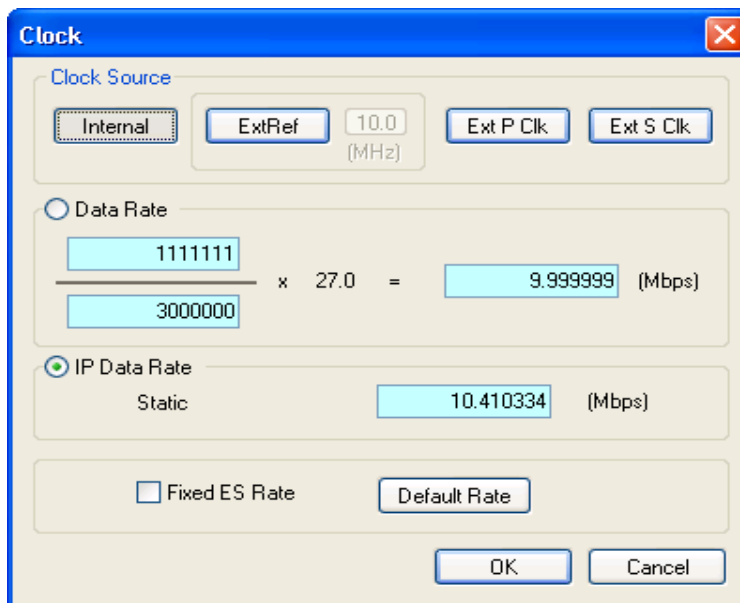

**Figure 10-8: Clock dialog box for IP interface**

**Clock Source:**

Sets the clock that will be used as the reference for the stream output. You can select the desired clock source from the following settings:

**Internal** uses the internal clock of the MPEG Player as the clock reference.

**Ext Ref** allows you to input a signal on the Reference Clock Input connector for use as the clock reference. When you select the button to the right of the ExtRef box, the External Reference dialog box is displayed.

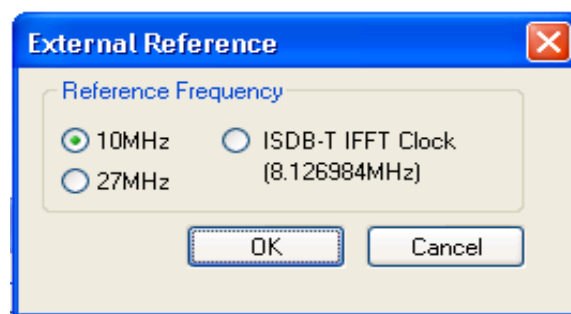

- **10 MHz:** Selects a 10 MHz signal on the Reference Clock Input connector.
- **27 MHz:** Selects a 27 MHz signal on the Reference Clock Input connector.
- **ISDB-T IFFT Clock:** Selects a signal corresponding to the IFFT sample clock rate (8.126984 MHz) on the Reference Clock Input connector.

Select the required option:

**Ext P Clk** (external parallel clock) allows you to input a clock signal on the Reference Clock Input connector for use as the parallel clock.

**Ext S Clk** (external serial clock) allows you to input a clock signal on the Reference Clock Input connector for use as the serial clock.

**Data Rate:**

Sets the clock rate for the transport stream output. You can enter the clock rate using the following methods (the first method provides greater clock-rate precision):

Enter values into the numerator and denominator text boxes (see Figure 10–7). The MPEG Player will then calculate the clock rate based on the ratio of the numerator and denominator values.

Enter a value into the clock rate text box. The MPEG Player will then calculate the numerator and denominator text boxes based on the clock rate.

---

**NOTE.** *The IP data rate will be automatically calculated based on the TS data rate available. IP Data Rate is calculated as follows:*

---

$$IP\ Data\ Rate = (TS\ Data\ Rate \times IP\ Packet\ Size) / Payload\ Size$$

---

When you use the Ext P Clk or Ext S Clk mode, set the clock rate to the same value as the input clock signal. Also, when you use the Ext S Clk mode, you cannot set the value more than 32 Mbps.

**IP Data Rate:** Sets the clock rate for the IP packet (see Figure 10–8). In the IP mode, a change in the IP data rate will impact the TS data rate and a change in the TS data rate will impact the IP data rate. The packet length changes according to the selected protocol.

---

**NOTE.** *The TS data rate will be automatically calculated based on the IP data rate available and consequently influence the PCR/PTS/DTS update cycles. TS Data Rate is calculated as follows:*

---

$$TS\ Data\ Rate = (IP\ Data\ Rate \times Payload\ Size) / IP\ Packet\ Size$$

---

**Fixed ES Rate:** Sets whether elementary stream rate is fixed. When it is checked, the elementary stream rate becomes constant regardless of the clock rate setting. If you fix the elementary stream rate, you cannot set the output clock rate (Data Rate) more than the data rate set when the stream file was downloaded.

When the Fixed ES Rate check box is enabled, PCR/PTS/DTS Update Method in the *Select Update Item* dialog box is set to Hardware automatically (see *Others Dialog Box* on page 10–32).

**Default Rate:** Displays the default clock rate and packet size and then changes the values. When you select this button, the following Default Clock dialog box appears.

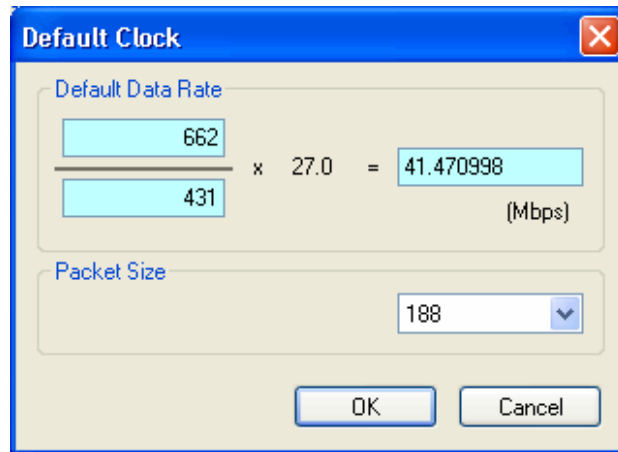

**Figure 10-9: Default Clock Dialog box**

**Default Data Rate:** Changes the default clock rate when the selected stream file was downloaded.

Since the default clock rate is calculated based on the PCRs in the downloaded stream file, the value can be different than the original clock rate. When the elementary stream rate is fixed (refer to the Fixed ES Rate description), the instrument refers to the default clock rate. Therefore, if the default clock rate is different than the original clock rate, you need to set the value to the appropriate value. If you change the value, the clock rate value in the Data Rate dialog box is also changed.

**Packet Size:** Changes the default packet size when the selected stream file is downloaded. If you change the value, the Packet Size setting in the Play menu will also change.

Press the **OK** button to enable all setting changes.

**Set Non-TS Sync Dialog Box.** When you select **Play > Sync > Non-TS**, the Set Non-TS Sync dialog box is displayed.



- **Psync Enable:** Sets the status of the PSYNC signal output from the SPI IN/OUT connector.
  - **Interval:** Sets the output period of the PSYNC signal in the range of 16 to 255 bytes. This value needs to be set equal to or greater than the Width value in the **Dvalid** field.
- **Dvalid Enable:** Sets the status of the DVALID signal output from the SPI IN/OUT connector.
  - **Width:** Sets the data width of the DVALID signal in the range of 16 to 255 bytes.

Press the **OK** button to enable all setting changes.

**PCR Initial Value Dialog Box.** When you select the **PCR Initial Value...** command from the Play menu, the PCR Initial Value dialog box is displayed.

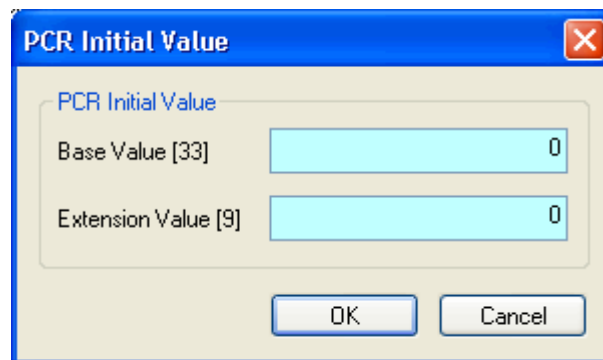

**Figure 10-10: PCR Initial Value dialog box**

- **Base Value:** Sets the initial value for the `program_clock_reference_base` value. You can set the value from 0 to 8589934591. The bracketed number represents the number of bits for the `program_clock_reference_base` field.
- **Extension Value:** Sets the initial value for the `program_clock_reference_extension` value. You can set the value from 0 to 299. The bracketed number represents the number of bits for the `program_clock_reference_extension` field.

**Start/Stop Position Dialog Box.** When you select the **Start/Stop...** command from the Play menu, the Start/Stop Position dialog box is displayed.

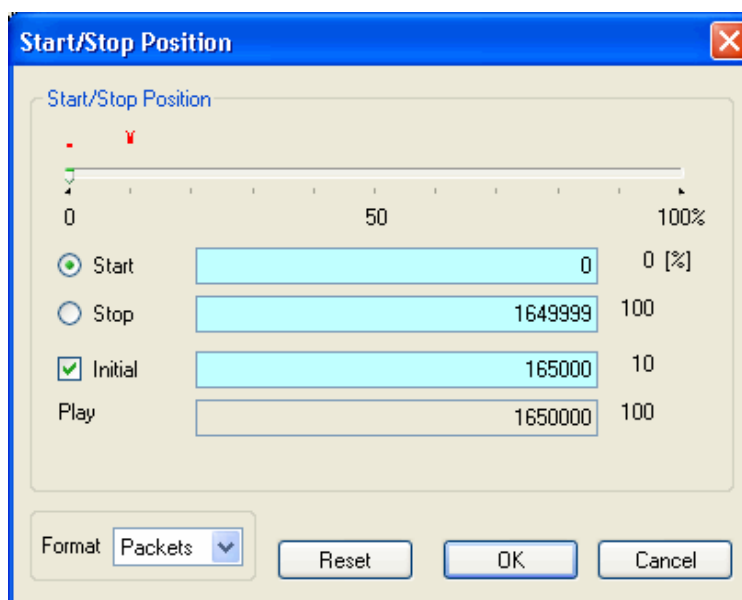

**Figure 10-11: Start/Stop Position dialog box**

- **Start:** Sets the start position of the stream by time (h:m:s) or the number of packets (the number of super frames for a M-TMCC file, or the number of bytes for a Non TS file). Use the **Format** list box to select the method of setting the position.
- **Stop:** Sets the stop position of the stream by time (h:m:s) or the number of packets (the number of super frames for a M-TMCC file, or the number of bytes for a Non TS file). Use the **Format** list box to select the method of setting the position.
- **Initial:** Sets the initial start position of the stream for loop output. You can set the value by time (h:m:s) or the number of packets (the number of super

frames for a M-TMCC file, or the number of bytes for a Non TS file). Use the **Format** list box to select the method of setting the position.

- **Play:** Shows the actual time or number of packets (the number of super frames for a M-TMCC file, or the number of bytes for a Non TS file) that is calculated by the values of the Start and Stop text boxes.
- **Format:** Specifies the method of setting the start, stop, and initial positions of the stream. For a transport stream file, you can select Time or Packets. For a M-TMCC file, you can select Time or SF (super frame). For a Non TS file, you can select Time or Bytes.

For an ISDB-T file, the start packet is defined as the first-appearing packet including an OFDM frame start flag after the specified start position. The stop packet is defined as the packet at the front of the last-appearing packet including an OFDM frame start flag before the specified stop position. At this time, if the number of OFDM frames between the start packet and stop packet is not an even number, the packet in the last OFDM frame becomes the stop packet.

You can set the start, stop, and initial positions by using either the slider or the text boxes.

#### Using the Slider:

Ensure that **Packets** is selected from the **Format** drop-down list.

1. For the start and stop positions:
  - a. Select the **Start** option button.
  - b. Using the mouse, drag the slider to the required start position.
  - c. Select the **Stop** option button.

This moves the slider to the right end.
  - d. Drag the slider to the required stop position.
  - e. Select the **OK** button to enable the values.
2. For the initial start position for loop output:
  - a. Enable the Initial check box. A red arrow appears on the slider.
  - b. Drag the red arrow to the required initial start position.
  - c. Select the **OK** button to enable the value.



**Using the text boxes:**

Ensure that **Time** is selected from the **Format** drop-down list.

1. Select the **Start** option button.
2. Enter the time in hour/minute/second format.
3. Repeat for the Stop time and the Initial Start Position time.
4. Select the **OK** button to enable the values.

To reset all of the settings to the values that were in effect when the dialog box was first displayed, select the **Reset** button, and then press the **OK** button.

**Timer Play/Record Dialog Box.** When you select the **Timer Play...** command from the Play menu, the Timer Play/Record dialog box is displayed.



**Figure 10-12: Timer Play/Record dialog box**

- **Start at:** Sets the date and time when the stream output or record starts.

When you press the **OK** button after setting the date and time, the current date and time and the set date and time are displayed. When the current date and time coincide with the set date and time, the dialog box closes and stream output or stream record starts automatically.

If you want to cancel the operation, select the **OK** button. When the dialog box that prompts you to confirm the operation is displayed, press the **OK** button to execute the operation.

**Others Dialog Box.** When you select the **Other...** command from the Play menu, the Others dialog box is displayed.

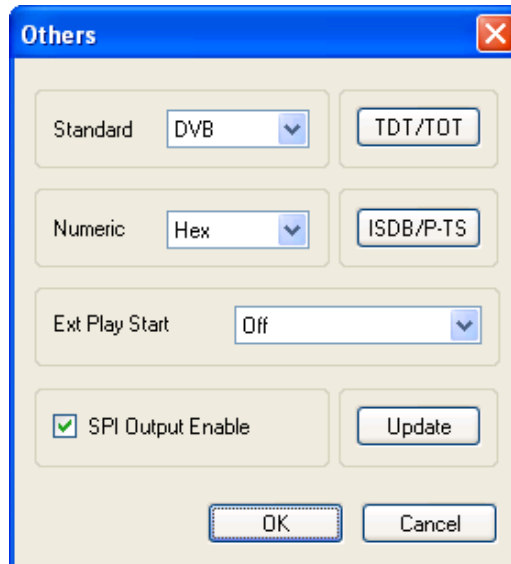

**Figure 10-13: Others dialog box**

- **Standard:** Sets the standard used on the hierarchy-display screen. You can select ARIB, ATSC, DVB, or MPEG2. For a transport stream (ARIB, ATSC, DVB, or MPEG2), the standard is set to the previous setting as a default. For an S-TMCC, M-TMCC, or ISDB-T transport stream, you need to select ARIB for proper display.
- **Numeric:** Sets the base value used to describe the component information in the hierarchy display. You can select Decimal, Hex, or Octal.
- **Ext Play Start:** Sets whether or not to start stream output using a trigger signal applied to the Trig In/Out connector. You can select Off, Rise, or Fall. When you select Rise, the stream output is started at the rising edge of the applied trigger signal. When you select Fall, the stream output is started at the falling edge of the applied trigger signal.
- **SPI Output Enable:** Sets whether the signal output from the SPI connector is enabled or not.
- **TDT/TOT or STT:** When you select this button, the following TDT/TOT dialog box appears. The button name changes which standard is selected in the Standard list box; TDT/TOT for ARIB or DVB, and STT for ATSC. Use this dialog box to change the initial date and time of the TDT (Time and Data Table), TOT (Time Offset Table), or STT (System Time Table) in the selected stream.

The button is disabled when MPEG2 is selected in the Standard list box.

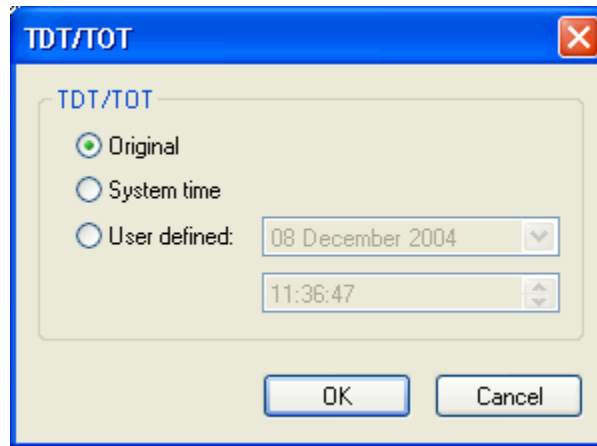

**Figure 10-14: TDT/TOT dialog box**

**Original:** Uses the original (default) value that is already defined in the selected stream.

**System Time:** Uses the clock/calendar of the operating system to set the initial value. When you select this option, the date and time of all the TDTs, TOTs, or STTs in the selected stream are locked to the clock/calendar of the operating system.

**User Define:** Uses the user-defined value to set the initial value. When you select this option, the list boxes for setting the initial date and time of the TDT, TOT, or STT are available.

- **ISDB/P-TS:** When you select this button, the following ISDB/P-TS dialog box appears.

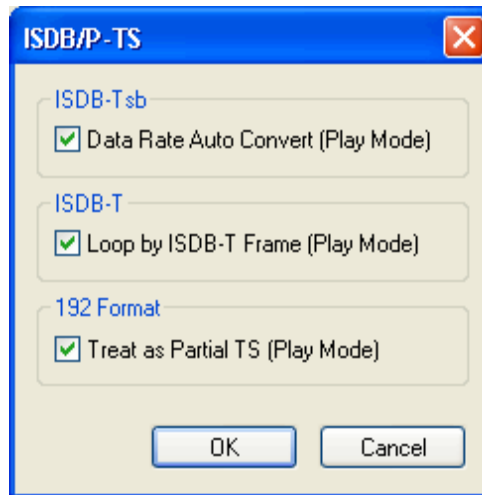

**Figure 10-15: ISDB/P-TS dialog box**

**Data Rate Auto Convert (Play Mode):** Sets whether to set the clock rate automatically when the ISDB-Tsb file is loaded. When this option is enabled, the clock rate is automatically set to  $(2048/1701) \times 27$  MHz and the elementary stream rate becomes constant, regardless of the Fixed ES Rate setting.

**Loop by ISDB-T Frame (Play Mode):** Sets whether to output the ISDB-T transport stream in OFDM frames when looped. When this option is not enabled, the ISDB-T transport stream is looped in packets.

**Treat as Partial TS (Play Mode):** Sets whether to output a stream file consisting of a 192-byte packet as a partial transport stream. When this option is not enabled, the stream is output in Non TS format.

- **Update:** When you select this button, the following Select Update Item dialog box appears. Use this dialog box to select which parameters in a stream are updated when looped.

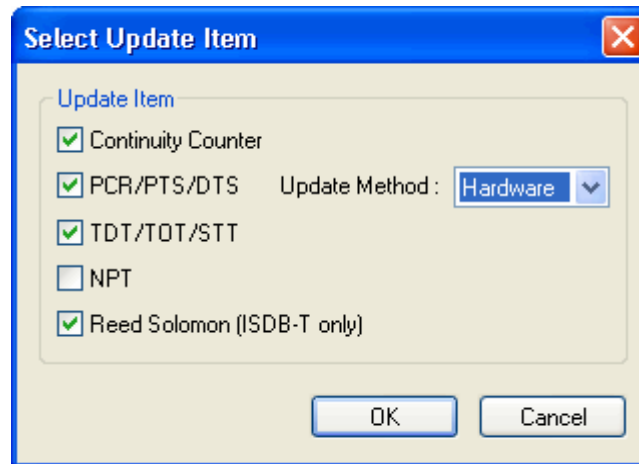

**Figure 10-16: Select Update Item dialog box**

**Continuity Counter:** Sets whether to update continuity\_counter.

**PCR/PTS/DTS:** Sets whether to update PCR (Program Clock Reference), PTS (Presentation Time Stamp), and DTS (Decoding Time-Stamp).

**Update Method:** Specifies the method to update PCR/PTS/DTS. The SPI/ASI/310M interface supports both Software and Hardware update methods but IP interface supports only the Software method.

- **Hardware:** PCR/PTS/DTS are updated using the counter values of the 27 MHz clock on the output board. Since data output and PCRs are completely locked, the continuity of PCRs is maintained at the loop point even if playing long stream loops. However, timing errors occur in PTS/DTS.
- **Software:** PCR/PTS/DTS are updated by adding the actual looping time (defined by the start and stop positions) to the stream every time it is looped. There are no timing errors in PTS/DTS, however, it is difficult to maintain the continuity of PCRs at the loop point because the updating is not synchronized with the 27 MHz clock on the output board. Since this method is used to update NPT, if you enable the NPT option, Software is selected automatically.

**TDT/TOT/STT:** Sets whether to update TDT (Time & Data Table), TOT (Time Offset Table), and STT (System Time Table).

**NPT:** Sets whether to update NPT (Normal Play Time; STC\_Reference field in NPT Reference Descriptor defined by ISO/IEC 18318-6).

The NPT check box is only available when PCR/PTS/DTS is enabled and Update Method is set to Software. When the check box is enabled, PCR/PTS/DTS becomes enabled and Update Method is set to Software. In addition, the Fixed ES Rate option in the Clock dialog box becomes disabled.

**Reed Solomon (ISDB-T only):** Sets whether to update Reed-Solomon codes in an ISDB-T transport stream.

Select the **OK** button to enable all setting changes.

**SPI/ASI/310M Interface  
Menu - Play**

Table 10–10 describes the commands available in the SPI/ASI/310M menu.

**Table 10–10: SPI/ASI/310M menu commands (Play screen)**

Command	Description
BNC Port	Sets the format of the output signal at the ASI/SMPTE Out connector: <b>ASI, 310M 8VSB</b> .
Through Out	Sets whether the signal supplied to the ASI/SMPTE In connector is looped back to the ASI/SMPTE Out connector when there is no recording or playout selected.
ASI Format	Selects either Byte or Packet when an ASI output is selected at the BNC Port. For Byte, valid data is output using a burst transmission mode. For Packet, valid data is output in each transport stream packet.

**IP Interface Menu - Play**

Table 10–11 describes the commands available in the IP menu.

**Table 10–11: IP menu commands**

Command	Description
Configuration	Configures the IP interface. The packet size, device name, protocol, ports, and the transmission mode can be set.
Parametric Settings	Sets the player process priority, transmitter thread priority, burst mode parameters, and jitter parameters.
Error Insertion	Inserts errors like packet loss, checksum, and sequence errors in the transmitted stream.

**Table 10–11: IP menu commands (Cont.)**

Command	Description
Error Generation	Generates errors like packet loss, checksum, and sequence in the transmitted stream manually.
Statistics	Displays details about parameter names, current stream values, and the history of the previous transmission.

**Configuration.** When you select Configuration from the IP menu, the IP Playout Configuration dialog box is displayed as shown in figure 10–17. This dialog box allows you to configure the following settings:

**Figure 10–17: IP Playout Configuration dialog box**

- **Configuration name:** Allows you to enter or select a configuration name from the drop down list. This list can store up to ten configuration names. The default value is blank.
- **Device Name:** Allows you to select the device for the IP playout. The Device Name lists all the active Network Interface Cards (NIC) in the system. The first interface that has a valid IP address assigned to it is automatically selected as the default value.
- **Source IP Address:** Sets the source IP address for the IP playout. The first valid IP address of the selected device will be set as the default. A custom-

ized value can be selected only if a different source address is first set in the Advanced Protocol Settings dialog box.

- **Source Port:** Sets the source port for the IP payout. The port value ranges from 0 to 65535. The default value for UDP protocol is 0 and for RTP protocol is 16384.
- **Transmission Mode:** Sets the transmission mode of the protocol. Unicast, Multicast, and Broadcast are the three transmission modes available in the drop down list. Multicast is set as the default value.
- **Protocol:** Sets the protocol (UDP, RTP) for the IP payout. RTP is set as the default value.
- **Destination IP Address:** Sets the destination IP address for the IP payout. 239.1.1.1 is set as the default value. Depending on the transmission mode selected the system will validate the entry based on the following rules:

**Unicast Range:** Any IP address that does not fall into the Multicast or the Broadcast range.

**Multicast Range:** 224.0.0.0 to 239.255.255.255

**Broadcast Range:** Network or node portion of an IP address will be set to “1”s or “0”s.

- **Destination Port:** Sets the destination port for the IP payout. The port value ranges from 0 to 65535. 16384 is set as the default value.
- **Enable VLAN:** Enables the VLAN layer that is present between the Ethernet layer and IP layer. You will have to enter the VLAN ID to allow the identification of 4096 VLANs that is basically used by the 802.1Q standard.
- **Advanced Protocol Settings:** Click Advanced Protocol Settings to view or customize the protocol settings of active protocols in the current configuration. All the settings has only header customization for which no validation will be done.



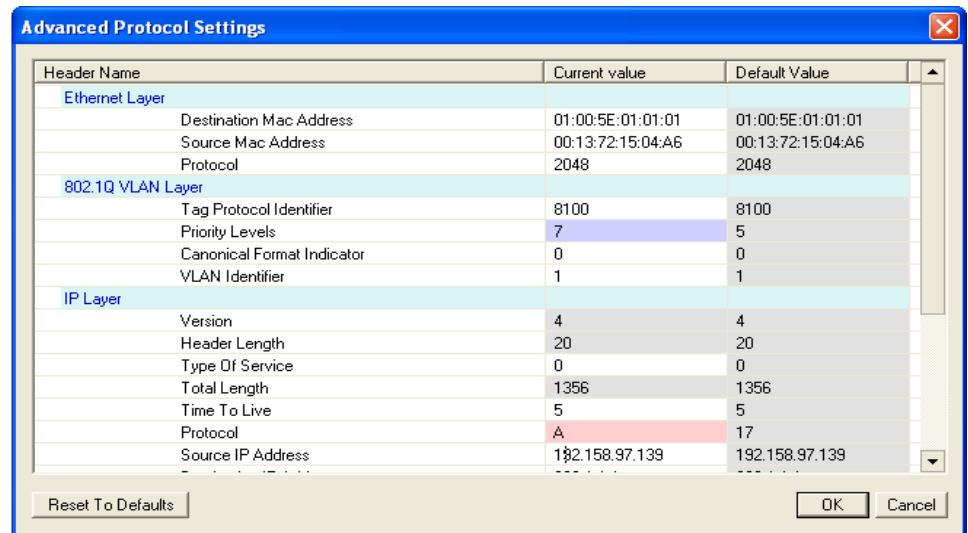

**Figure 10-18: Advanced Protocol Settings dialog box**

The Header Name and Default Value are read only options. The protocol headers displayed will be limited to headers common to all packets. You can customize the Current value of the headers which can be specified at packet creation. The customized valid values are displayed in lavender and the customized invalid values are displayed in pink.

Click the Reset to Defaults button to reset the current values to default values. Whenever any of the attributes are set, an icon is displayed in the status bar during the play.

If VLAN is enabled with VID set to a value, the Advanced Settings dialog box displays all the VLAN attributes under 802.1Q VLAN Layer header.

- Stream Replication Settings:** Click Stream Replication Settings to set the number of replicated streams and customize the attributes accordingly. This settings is used to replicate the streams wherein a stream is replicated n times with certain attributes of the stream incremented by a value with in the n replicated streams. The customized valid values are displayed in lavender and customized invalid values are displayed in pink.

You can enter the number of replications in the Number of replicated streams text box. The table lists the attributes which can be incremented by entering a number in the Increment Value column. All attributes except for MACs and IP addresses will accept an integer.

If VLAN is enabled with VID set to a value, the Stream Replication Settings dialog box displays all the VLAN attributes under 802.1Q VLAN Layer header.

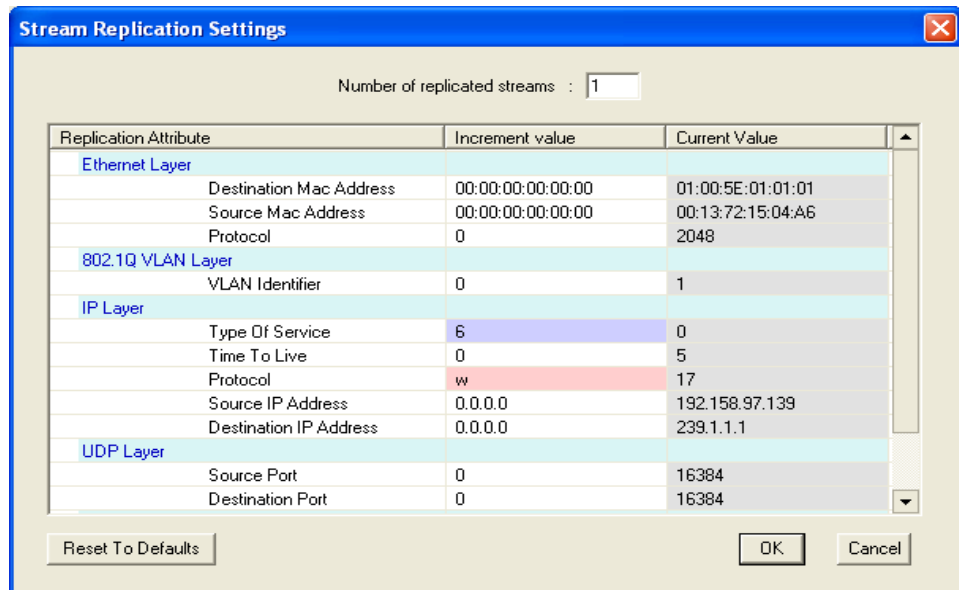

**Figure 10-19: Stream Replication Settings dialog box**

You can click Reset to Defaults to reset the increment values to default values. Whenever the stream replication is active, an icon is displayed in the status bar during the play.

- **Allow TS Fragmentation:** Controls the fragmentation of the transport stream packets. If this option is selected, the transport stream packets will be split across the IP packets else all the transport stream packets will be present in the IP packet. The cleared option is the default option. The IP Packet size and Number of TS packets option will be enabled only if TS fragmentation is allowed. When TS fragmentation is not allowed only the Number of TS packets option is enabled.
- **Allow IP Fragmentation:** Controls the fragmentation of IP packets. This option is applicable to packet sizes which are greater than the MTU size of the interface (typically 1500B). If this option is selected, the IP packets are fragmented else they will be retained with the same size. The cleared option is the default option. The maximum packet size is 16128 when IP fragmentation is selected.
- **IP Packet Size:** Allows you to set the size of IP packet. This option is enabled only if TS fragmentation is allowed. When IP fragmentation is enabled the maximum size of the packet is 16128 bytes and when disabled it is 1500 bytes..

The IP packet size includes the headers and hence the payload size is calculated at runtime using the following equation:

$$IP\ Packet\ Size = Payload\ Size + Header\ Size$$

where header size is 54 (58 if VLAN is enabled) for RTP and 42 (46 if VLAN is enabled) for UDP

- **Number of TS Packets:** Allows you to type the number (integers) of TS packets that needs to be embedded into an IP packet.

The maximum IP packet size is 1500 bytes or equivalent to TS packets.

A read only text field showing the IP packet size is displayed next to this option. The IP packet size will be calculated automatically and displayed in bytes. Based on the number of TS packets, the IP packet size is calculated using the following equation:

$$IP\ Packet\ Size = Payload\ Size + Header\ Size$$

where payload size is calculated as follows:

$$Payload\ Size = Number\ of\ TS\ Packets \times TS\ Packet\ Size$$

- **Store Settings:** Stores or updates the entire configuration settings including the Advanced Protocol Settings. All these settings will be listed out in the Configuration Name drop down list.
- **Delete Settings:** Deletes the selected configuration setting that is displayed in the Configuration Name drop down list and selects the next configuration in the list. If there are no more configurations stored in the list, the values in the configuration dialog box will be reset to the default values.
- **Clear Settings:** Clears the selected configuration setting including the Advanced Protocol Settings and resets them to the default values.

**Parametric Settings.** When you select Parametric Settings from the IP menu, the Parametric Settings dialog box is displayed as shown in figure 10–20 .

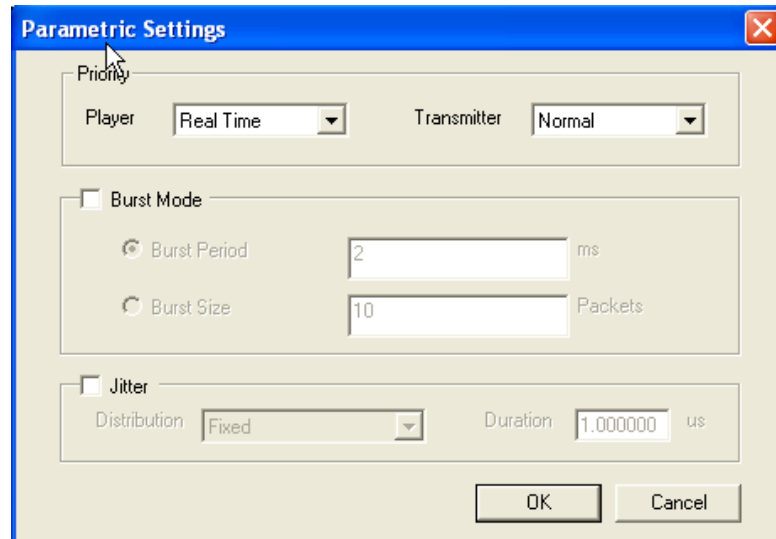

**Figure 10–20: Parametric Settings dialog box**

The Parametric Settings dialog box allows you set the following:

- **Priority:** Allows you to set the priority of the player and the transmitter thread.

**Player:** You can set the process priority for the player in IP mode. The priorities available are Real Time, Normal, Above Normal, Highest. Above Normal is selected by default.

**Transmitter:** You can set the priority for the transmitter thread. The priorities available are Idle, Below Normal, Normal, Above Normal, Highest, and Real Time. Real Time is selected by default.

- **Burst Mode:** Allows you to transmit the player thread in the form of bursts. Burst mode is not selected by default.

**Burst Period:** You can set the time during which the packets will be transmitted in the burst mode. Burst period is selected by default.

**Burst Size:** You can set the burst size which determines the number of packets being transmitted in every burst.

- **Jitter:** Inserts jitter during IP playout. There are four types of jitter distribution namely Fixed, Laplacian, Gaussian, and Sinusoidal. Fixed is the default

jitter distribution. When Fixed is selected a Duration text box is displayed wherein you can enter the jitter in microseconds.

When Laplacian, Gaussian, or Sinusoidal is selected a slider is displayed wherein you can set the jitter as percentage of the interpacket time by moving the slider. The interpacket gap will follow the selected jitter distribution.

The overall bit rate of the playout is not affected by jitter insertion.

**Error Insertion.** When you select Error Insertion from the IP menu, the Error Insertion dialog box is displayed as shown in Figure 10–21. This dialog box allows you to insert errors during playout. For Non-TS playout the error insertions is limited to packet drop and checksum errors.

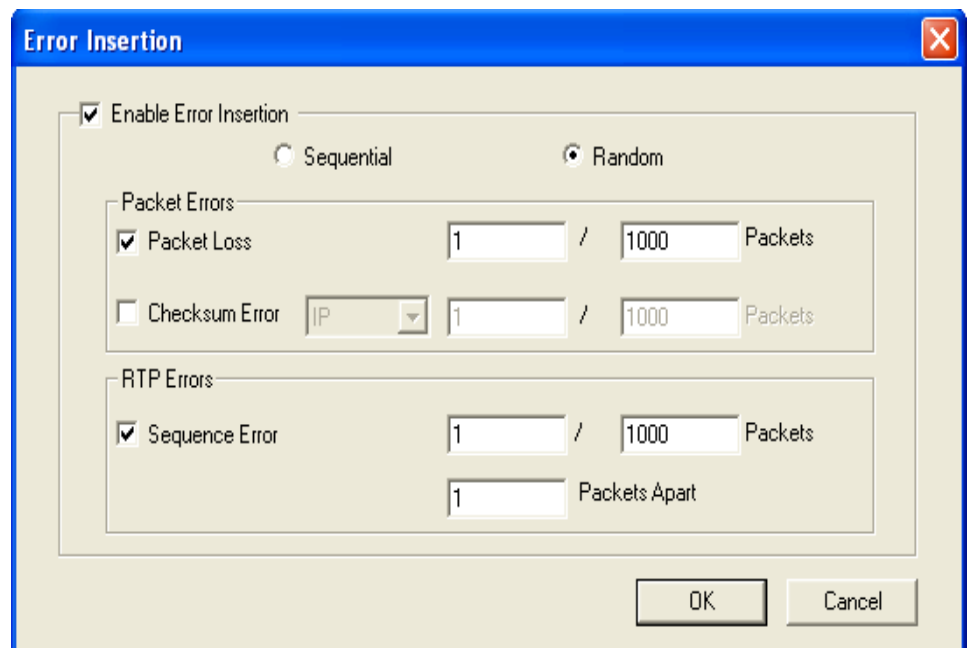

**Figure 10–21: Error Insertion dialog box**

- Enable Error Insertion:** Enables error insertion. You can have error insertion in sequential or random order. All error insertions are specified as X error per Y packets except for jitter.

**Sequential:** The errors are inserted in sequential packets, that is for every Y packets the first X packets have errors inserted in them.

**Random:** The errors are inserted in random packets, that is for every Y packets X random packets have errors inserted in them. Random mode is set as the default.

- **Packet Loss:** Inserts packet loss. The packets are dropped at a frequency you specify. You can specify the rate as X packets within Y packets.
- **Checksum Error:** Inserts checksum error. The checksum error can be inserted in either UDP or IP layers. The CRC errors are generated in packets at a frequency you specify. You can specify the rate as X packets within Y packets.
- **Sequence Error:** Inserts packet sequence error. This option is enabled only if RTP protocol is selected in the the IP configuration Playout dialog box. The packets will be reordered at the frequency specified in the Packets text box. You can enter the number of packets after which you want the reordering to happen in the Packets Apart text box. You can specify the rate as X packets per Y packets after every Z number of packets.

**Error Generation.** When you select Error Generation from the IP menu, the Error Generation dialog box is displayed as shown in Figure 10–22. This dialog box allows you to insert errors manually.

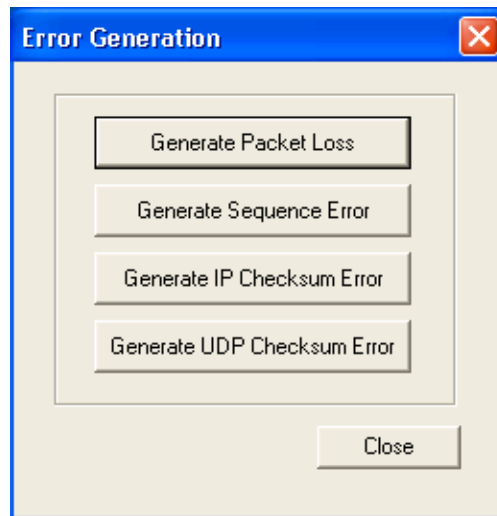
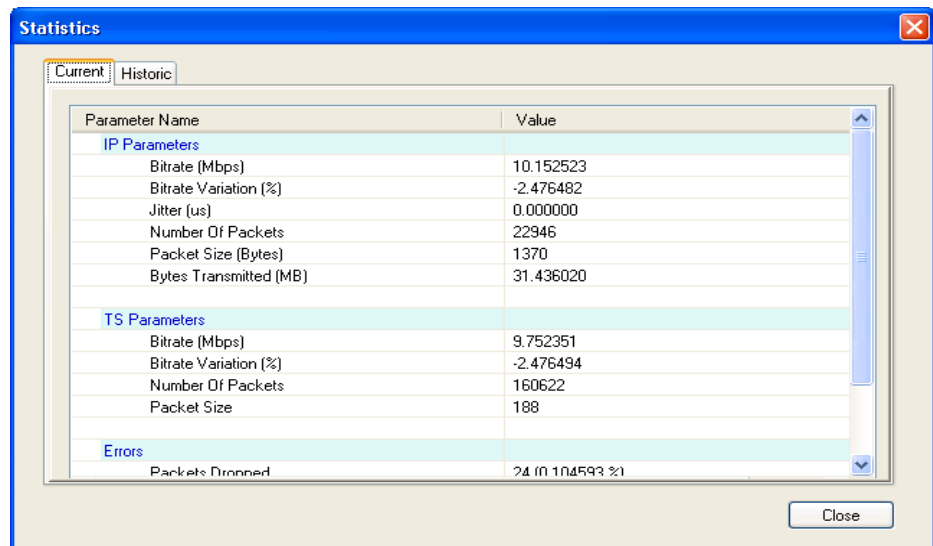

**Figure 10–22: Error Generation dialog box**

- **Generate Packet Loss:** Drops an IP packet during the IP playout. The number of packets dropped will be equal to the number of times you click the button.

- **Generate Sequence Error:** Generates sequence error manually. When you click this button the packet will be re-sequenced with another packet within a 100-packet boundary.
- **Generate IP Checksum Error:** Generates checksum errors manually in the IP layer.
- **Generate UDP Checksum Error:** Generates checksum errors manually in the UDP layer.

**Statistics.** When you select Statistics from the IP menu, the Statistics dialog box is displayed. The player displays the current and historic statistics of IP parameters, TS parameters, and Errors. These will be retained till the start of next play or until a new file is opened.



The screenshot shows a dialog box titled "Statistics" with a blue header and a close button in the top right corner. Inside the dialog, there are two tabs: "Current" (selected) and "Historic". Below the tabs is a table with two columns: "Parameter Name" and "Value". The table is divided into three sections: "IP Parameters", "TS Parameters", and "Errors".

Parameter Name	Value
<b>IP Parameters</b>	
Bitrate (Mbps)	10.152523
Bitrate Variation (%)	-2.476482
Jitter (us)	0.000000
Number Of Packets	22946
Packet Size (Bytes)	1370
Bytes Transmitted (MB)	31.436020
<b>TS Parameters</b>	
Bitrate (Mbps)	9.752351
Bitrate Variation (%)	-2.476494
Number Of Packets	160622
Packet Size	188
<b>Errors</b>	
Packets Dropped	24 (0.104593 %)

A "Close" button is located at the bottom right of the dialog box.

**Figure 10-23: Statistics dialog box without Stream Replication**

The screenshot shows a 'Statistics' dialog box with a blue title bar and a close button. It has two tabs: 'Current' (selected) and 'Historic'. The main area contains a table with three columns: 'Parameter Name', 'Value (per Stream)', and 'Total Value (in 2 Streams)'. The table is divided into three sections: 'IP Parameters', 'TS Parameters', and 'Errors'. The 'Errors' section only shows 'Packets Dropped' with a value of 0.

Parameter Name	Value (per Stream)	Total Value (in 2 Streams)
<b>IP Parameters</b>		
Bitrate (Mbps)	2.104416	4.208832
Bitrate Variation (%)	1.073493	1.073493
Jitter (us)	0.000000	0.000000
Number Of Packets	6522	13044
Packet Size (Bytes)	1370	1370
Bytes Transmitted (MB)	8.935140	17.870280
<b>TS Parameters</b>		
Bitrate (Mbps)	2.021468	4.042936
Bitrate Variation (%)	1.073403	1.073403
Number Of Packets	45654	91308
Packet Size	188	188
<b>Errors</b>		
Packets Dropped	0	0

**Figure 10–24: Statistics dialog box with Stream Replication**

- Current:** Displays the instantaneous statistics of parameters at that time. Once the play is started, this dialog box is refreshed at the rate of every second.

**IP Parameters:** The current bit rate, percentage variation of this current bit rate from the nominal (set) bit rate, number of IP packets transmitted, and the IP packet size used for the playout are all displayed. The jitter value which reflects the insertions done at runtime is also displayed.

**TS Parameters:** The TS bit rate of the MPEG file being played is displayed. The number of TS packets and the TS packet size is also displayed. If the player is in the Non-TS mode then all the statistics will display Non-TS playout.

**Errors:** Number of packets dropped, packet loss rate, sequential errors, and checksum errors for both IP and UDP are all displayed.

**Value (per stream):** When stream replication is enabled, the Current tab displays the Value column as shown in figure 10–24. This column gives the value of each parameter per stream.

**Total Value (in n streams):** When stream replication is enabled, the Current tab displays the Total Value column as shown in figure 10–24. This column gives the total value of each parameter for the set number of streams. Here n streams is equal to the sum of the replicated streams and the actual stream.



- Historic:** Displays the minimum, maximum, and average values of parameters (IP, TS) for the current play. When stream replication is enabled, the history tab signifies that the statistics displayed is per flow.

**IP Parameters:** The current bit rate, percentage variation of this current bit rate from the nominal (set) bit rate, and the jitter value are displayed.

**TS Parameters:** The bit rate and the percentage variation from this bit rate are displayed.

**Utility Menu** Table 10–12 describes the commands in the Utility menu.

**Table 10–12: Utility menu commands**

Command	Description
Communication ...	<p>Sets the port number that is needed to remotely control the MPEG Player over an Ethernet network and the terminator that is used to communicate with a controller.</p> <p>When you select this command, the Communication dialog box appears. Refer to <i>Communications Dialog Box</i> on page 10–47 for more information.</p>
About...	<p>Displays general system information including the software and hardware versions.</p> <p>When you select this command, the About dialog box appears. Refer to <i>About Dialog Box</i> on page 10–49 for more information.</p>

**Communication Dialog Box.** When you select the Communication command from the Utility menu, the **Communication...** dialog box is displayed.

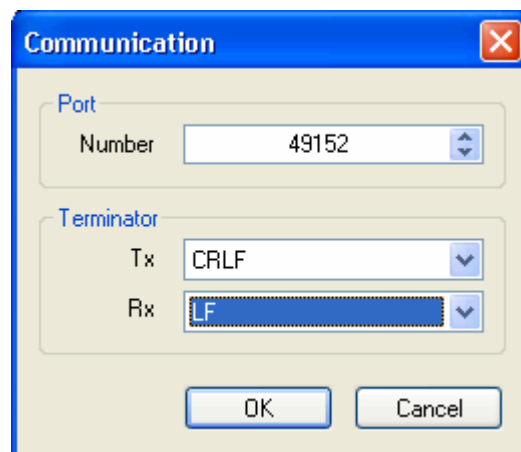

**Figure 10–25: Communication dialog box**

- **Port Number:** Sets the port number needed to remotely control the MPEG Player over an Ethernet network. You can set the value from 1024 to 65535.
- **Terminator**
  - **Tx:** Selects the terminator that is used when the MPEG Player sends information to a controller. You can select LF (linefeed), CR (carriage return), CRLF (carriage return and linefeed), or LFCR (linefeed and carriage return).
  - **Rx:** Selects the terminator that is used when the MPEG Player receives commands from a controller. You can select LF (linefeed) or CR (carriage return).

Select the **OK** button to enable all setting changes.

**About Dialog Box.** When you select the **About...** command from the Utility menu, the About dialog box is displayed.



This dialog box shows the version of the MPEG Player application and hardware version of the main and installed interface modules - your versions may differ.

## Menus in the Record Screen

This subsection describes the menus available in the Record screen.

---

**NOTE.** The IP interface mode does not support the Record functionality and hence the Record option is disabled for IP.

---

**File Menu** The File menu in the Record screen contains commands for setting the save mode and for saving and loading a preset file.

**Table 10-13: File menu commands (Record screen)**

Component	Text
Save	Specifies the file name used when you save a stream data. When you select this command, the Save as dialog box appears. By default, the current data (yymmdd) is used as a file name.
Save Mode	Sets the save mode when you save stream data. You can select Over Write or New File. In the Over Write mode, the existing file is over written by the new file with the name specified in the Save command whenever you save a stream data. In the New File mode, a new file is created whenever you save a stream file. The file name is the following: the name specified by the Save commands + # (1,2,3,4...).
Load Preset	Loads the specified preset file (*.set). When a preset file is loaded, the current instrument settings are changed by the file's content. Refer to Preset File, page 10-61, for more information about the preset file.
Save Preset	Saves the current instrument settings as a preset file. Refer to Preset File, page 10-61, for more information about the preset file.
PLAY	Switches to the Play screen.
Exit	Quits the MPEG Player application. The MPEG Player application settings are saved.

**View Menu** The View menu contains commands that control the display of the Toolbar and Status bar. The View menu in the Record screen is the same as that in the Play screen. Refer to Table 10-8 for the commands available in the View menu.

**Record Menu** The Record menu contains commands for setting the input interface, record size, trigger position, and target source. Table 10–14 describes the commands in the Record menu.

**Table 10–14: Record menu commands**

Command	Description
Source	Sets the interface used to input a stream data. You can select SPI (DVB SPI connector) or SPI/ASI/310M (ASI/SMPTE In BNC connector).
Target...	Sets the record size, trigger position, and target source to record the input stream.  When you select this command, the Target dialog box appears. Refer to <i>Target Dialog Box</i> on page 10-52 for more information.
Timer Record...	Sets the time used to record the input stream automatically.  When you select this command, the Timer Play/Record dialog box appears. Refer to <i>Timer Play/Record Dialog Box</i> on page 10-31 for more information.
Other...	Sets the standard used to display the input stream and the external trigger status.  When you select this command, the Others dialog box appears. Refer to <i>Others Dialog Box</i> on page 10-32 for more information.

**Target Dialog Box.** When you select the **Target** command from the Record menu, the Target dialog box is displayed.

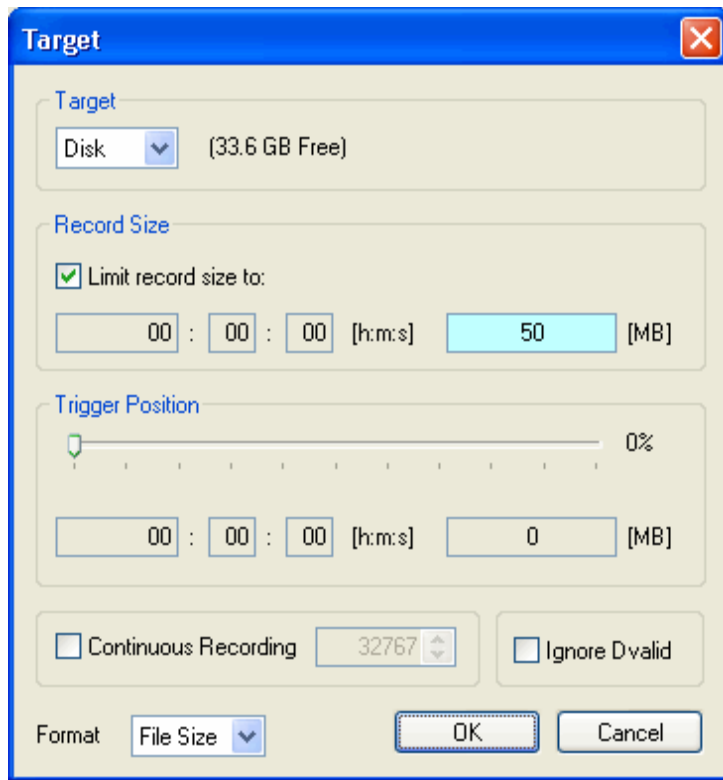

- **Target:** Sets the record target - RAM or hard disk.
- **Record Size:** Sets the recording time (h:m:s) or file size (MB) to record the input stream. Use the **Format** list box to select the way to set the record size.

The amount of free space available for the RAM or hard disk is displayed below the data size text box. You cannot set the record size beyond this value.

Disable the **Limit record size** check box to record the input stream to the full free space in the hard disk or RAM. When the **Limit record size** check box is enabled, the size (in MB) or the available recording time and data size are automatically set. In addition, when the check box is enabled, the Continuous Recording check box becomes disabled.

---

**NOTE.** When you set the pretrigger portion, the same free space as the record size is required.

---

There is a list box in the **Record Size** field to select which record target (RAM or hard disk) is used to record the input stream.

- **Trigger Position:** Sets the trigger position used to record the input stream. You can set the trigger position by a time (h:m:s) or file size (MB).
- **Continuous Recording:** Sets whether to enable Continuous Recording. With Continuous Recording, you can record multiple stream files continuously on the hard disk.

When the check box is enabled, the spin box (at the right side of the check box) becomes available. Use the spin box to set the number of files to create before stopping Continuous Recording. After the specified number of files are created, stream capture stops automatically. You can set the value from 2 to 32767.

When this option is selected, the Without Limit check box becomes disabled.

Refer to *Using the Continuous Recording Feature*, beginning on page 10–62, for detailed information about Continuous Recording.

- **Ignore Dvalid:** Sets whether the MPEG Player ignores the DVALID signal from the selected interface when a stream data is acquired. When it is checked, the MPEG Player ignores the DVALID signal, and the stream data is acquired according to the internal clock signal. This option is not available for the ASI interface option.
- **Format:** Specifies the way to set the record size and trigger position. You can select Time or File Size.

Select the **OK** button to enable all the settings and to close the dialog box.

**Others Dialog Box** When you select the **Other...** command from the Record menu, the **Others** dialog box is displayed.

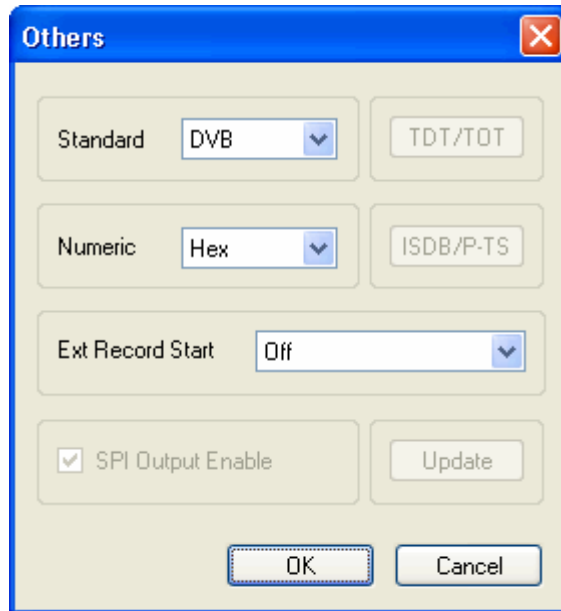

- **Standard:** Sets the standard used to display the input stream. You can select ARIB, ATSC, DVB, or MPEG2.
- **Numeric:** Sets the base value used to describe the component information in the hierarchy display. You can select Decimal, Hex, or Octal.
- **Ext Record Start:** Sets whether or not to start input stream record using a trigger signal applied to the TRIG IN connector. You can select Off, Rise, or Fall. When you select Rise, the input stream record is started at the rising edge of the applied trigger signal. When you select Fall, the input stream record is started at the falling edge of the applied trigger signal.

When you use the external trigger signal to record the input stream, if the pretrigger portion is defined, the MPEG Player acquires pretrigger data when a valid trigger signal occurs and then waits for a trigger. When a valid trigger signal occurs again, the MPEG Player acquires posttrigger data and then creates a stream file.

- **SPI Output Enable:** This item cannot be accessed from the Record screen.

Select the **OK** button to enable all setting changes.



## SPI/ASI/310M Interface Menu - Record

**Table 10–15: SPI/ASI/310M menu command (Record screen)**

Command	Description
Input Port	Selects either DVB/SPI In ( <b>SPI</b> ) or ASI/SMPTE In ( <b>BNC</b> ) connector for recording input.
BNC Port	Selects either <b>ASI</b> or <b>310M</b> (SMPTE 310) as BNC input.

## Utility Menu

The Utility menu contains commands for displaying the system information such as software and hardware versions. The Utility menu in the Record screen is the same as that of the Play screen. Refer to Table 10–12 for detailed information.

## Toolbar Buttons

The toolbar provides shortcut buttons for many of the most often used menu commands. Click a toolbar button to select the corresponding command.







↑  
Toolbar button

Table 10–16 shows the toolbar buttons and their functions.

**Table 10–16: Toolbar button descriptions**

Icon	Name	Function
	LOAD TS file	Opens the Select File dialog box. Equivalent to the <b>Open</b> command in the File menu. This button is available when the Play screen is displayed.
	SAVE TS file	Opens the Save as dialog box. Equivalent to the <b>Save</b> command in the File menu. This button is available when the Record screen is displayed.
	Load Preset	Opens the Open dialog box. Equivalent to the <b>Load Preset</b> command in the File menu.
	Save Preset	Opens the Save as dialog box. Equivalent to the <b>Save Preset</b> command in the File menu.
	Play	Outputs the selected stream. Equivalent to the <b>PLAY</b> button on the front panel.

**Table 10-16: Toolbar button descriptions (Cont.)**

Icon	Name	Function
	Record	Records the acquired stream. Equivalent to the <b>RECORD</b> button on the front panel.
	Stop	Stops the stream output or stream record. Equivalent to the <b>STOP</b> button on the front panel.
	Clock	Opens the Clock dialog box. Equivalent to the <b>Clock</b> command in the Play menu. This button is available when the Play screen is displayed.
	Target	Opens the Target dialog box. Equivalent to the <b>Target</b> command in the Record menu. This button is available when the Record screen is displayed.

# Reference

This section contains information about the following MPEG Player features:

- Outputting streams
- Adding jitter to PCRs
- Using Preset files
- Using the Continuous Recording Feature
- Remote control

## Interface Card (SPI/ASI/310M Option)

Refer to the MTS400 Technical Reference Manual for detailed specifications of the interface card connectors.

### About the Data Output Source

When you output the selected stream data, you can select either the hard disk or the RAM as an output source. This subsection describes the operation of the MPEG Player when each output source is selected.

**RAM.** When you select the RAM as an output source, the MPEG Player performs the following:

- When data output rate is less than or equal to 120 Mbps, the MPEG Player outputs the first stream data while transferring the data from the hard disk to the RAM and then continuously outputs the data from the RAM using looping methods.
- When data output rate is more than 120 Mbps, the MPEG Player continuously outputs a stream data from the RAM using looping methods after the data is completely transferred from the hard disk to the RAM.

If you select the RAM as an output source, you cannot output data in excess of the RAM free space for the data output. This RAM free space is displayed on the status bar.

**Hard Disk.** If you select the hard disk (Disk) as an output source, the MPEG Player always outputs the selected stream data from the hard disk regardless of the data output rate. When the reading speed of the hard disk cannot overtake the data output rate, the error message “Error: Output Buffer Empty” appears.

Use the Source command in the Play menu to select the output source (see Table 10–22). You can see the currently selected output source in the status bar.

## Adding Jitter to PCRs

The MPEG Player provides the capability to add jitter to PCRs (Program Clock References). Adding jitter to PCRs allows you to simulate transmission delay variations and to test the robustness of decoders under various conditions.

The jitter function adds jitter to the `program_clock_reference_base` value and the `program_clock_reference_extension` value in the adaptation field of transport stream packets. You can use this function to modulate the data values of the PCRs away from their correct values.

### Adding Jitter

Perform the following procedure to add jitter to PCRs:

1. Highlight a PCR element in the hierarchy display and select PCR Accuracy Variation... from the right-click menu.

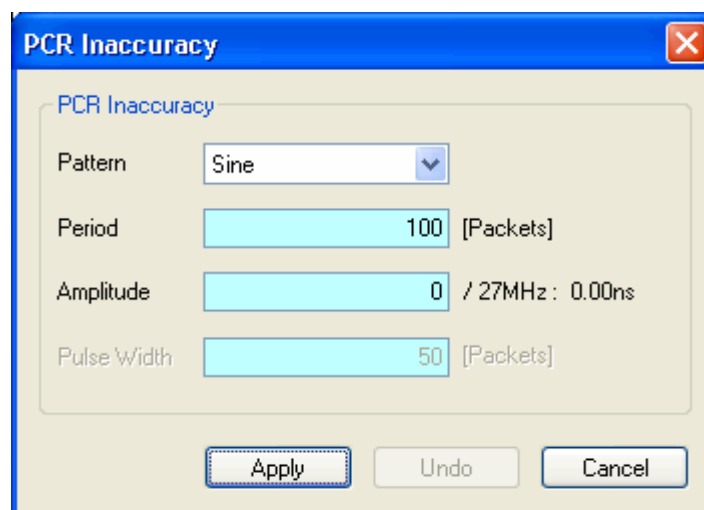

Figure 10–26: PCR Inaccuracy dialog box

2. The PCR Accuracy Variation dialog box lets you set how the parameters for how jitter will be added to the PCR.
  - **Pattern:** Selects the waveform type of the waveform used to add jitter. You can select Sine, Square, Triangle, Pulse, Sawtooth, Random, or Offset.
  - **Period:** Sets the period of the waveform used to add jitter. You can set the value from 5 to 3000 packets in 1 packet steps.
  - **Amplitude:** Sets the amplitude of the waveform used to add jitter. You can set the value from 0/27 MHz to 135000000/27 MHz (0 s to 5 s).
  - **Pulse Width:** Sets the pulse width of the waveform used to add jitter. You can set the value from 1 to (period-1) packet(s) in 1 packet steps. This Pulse Width parameter is available only when the Pattern parameter is set to Pulse.
3. After you have set the parameters, press the **Apply** button to enable the jitter function.

Note that the PCR icon in the hierarchy display changes.

To disable the jitter function, open the PCR Inaccuracy dialog box and select the **Undo** button. Note that the PCR icon in the hierarchy display changes.

Figure 10–27 shows the relationship among the parameters and how the PCR values (program\_clock\_reference\_base value and program\_clock\_reference\_extension) change when Sine is selected as a jitter-pattern waveform. The PCR values vary by the value of sine waveform defined by the amplitude and period. The PCR period does not change.

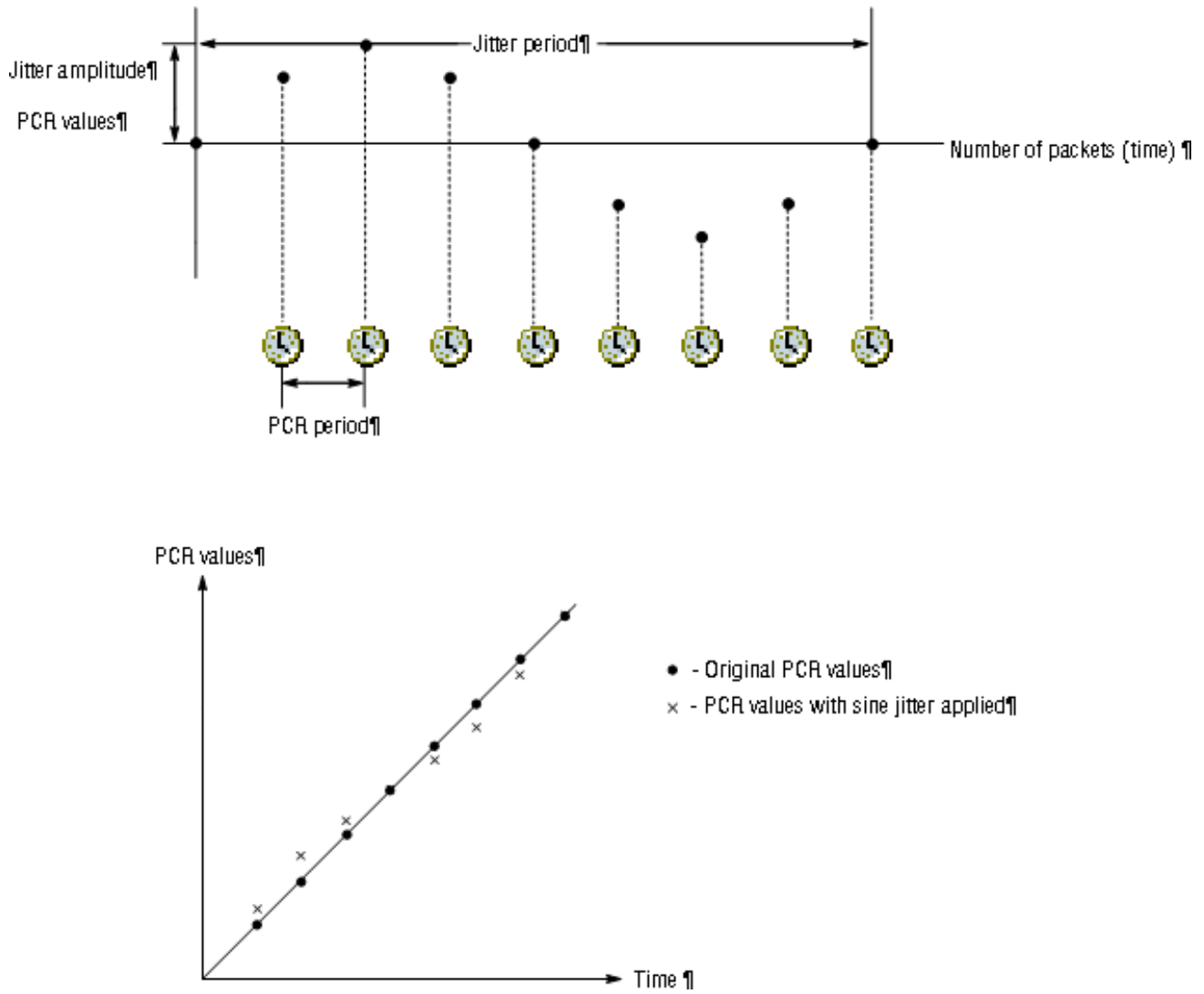

Figure 10-27: Jitter function with a sine jitter pattern applied

## Using Preset Files

You can save the instrument settings that you defined as a preset file, so that you can later restore those settings.

### Contents of the Preset File

Preset files can be created for the Play screen and for the Record screen.

- In the Play screen, you can save settings for stream output. All of the parameter settings available in the Play menu are saved as a preset.
- In the Record screen, you can save settings for stream record. All of the parameter settings available in the Record menu are saved as a preset.

### Saving a Preset File

Use this procedure to save the current instrument settings as a preset file.

Perform the following steps to save a preset file:

1. Make the required instrument settings.
2. Select **File > Save Preset**. The **Save As** dialog box is displayed.

In the File name text box, the following default file names are created as follows:

- Play Screen: A two-digit serial number is added to the selected file name (for example, if the selected file name is “Test\_TS”, the default file name becomes “Test\_TS00”).
- Record Screen: A two-digit serial number is added to the name “Preset”; for example “Preset01”.

You can change the file name as required.

3. Select **OK** to save the instrument settings as a preset file.

### Loading a Preset File

Perform the following steps to load an instrument setup from a preset file.

1. Select **File > Load Preset**. The **Open** dialog box is displayed.
2. Highlight the required file.
3. Press **OK** to load the preset file into the MPEG Player.

## Using the Continuous Recording Feature

The Continuous Recording feature allows you to record multiple stream files continuously on the hard disk.

Continuous Recording has the following features:

- Record multiple stream files continuously on the hard disk
- Variable file size operation
- The time stamp information of the first trigger event in a file is recorded as the updated date property of the file
- Can be used in disk recording mode

### Basic Action of Continuous Recording

This section describes how files are recorded by the location of the trigger events in Continuous Recording.

The following explanation requires that both pretrigger and posttrigger sizes to be set to 500 MB.

- In general, each trigger event occurs intermittently. In this case, each file contains one trigger event in the file, and the pretrigger and posttrigger areas have the specified size.

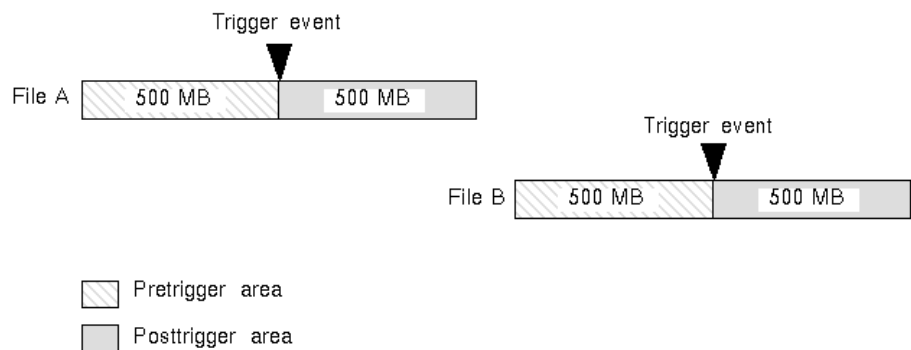



- If a trigger event occurs while the pretrigger area is filled with data, the pretrigger area becomes smaller than the specified size. However, the posttrigger area keeps the specified size. In this case, the size of the File A is smaller than the specified size.

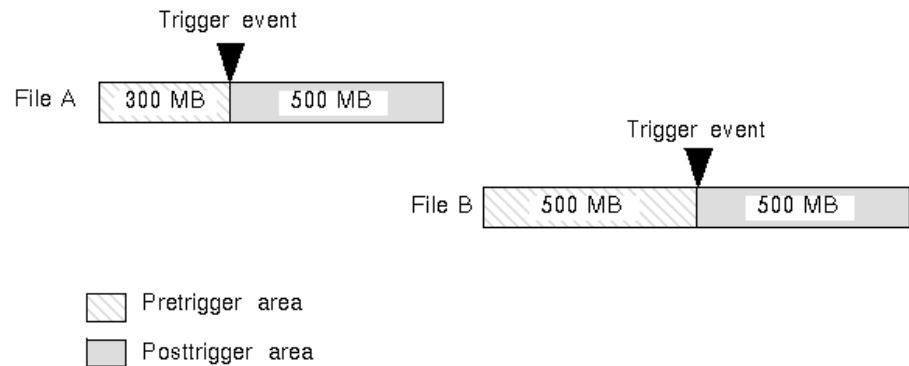

- If the second trigger event occurs while the posttrigger area is filled with data, the second trigger event is ignored.

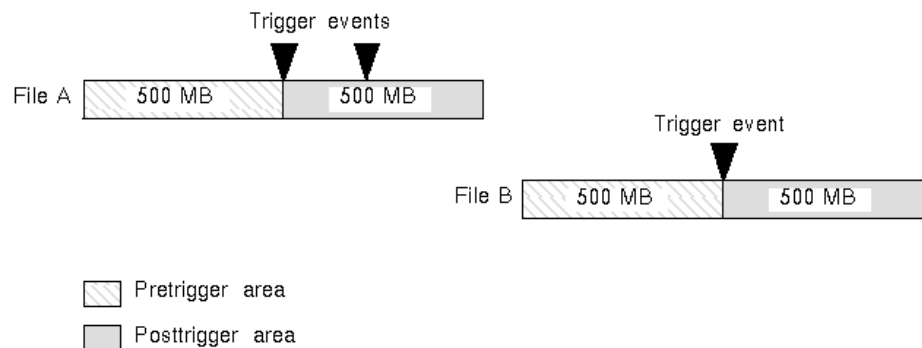

---

**NOTE.** If the trigger position is set to 0 (%), each file is created whenever a trigger event occurs.

---

## Performing Continuous Recording

Use the following procedure to perform Continuous Recording:

1. Select **File > Save...** to open the **Save** dialog box.
2. In the dialog box, select the folder where stream files are to be saved.
3. Select **Record > Target...** to open the **Target** dialog box.
4. In the dialog box, select the **Continuous Recording** check box.

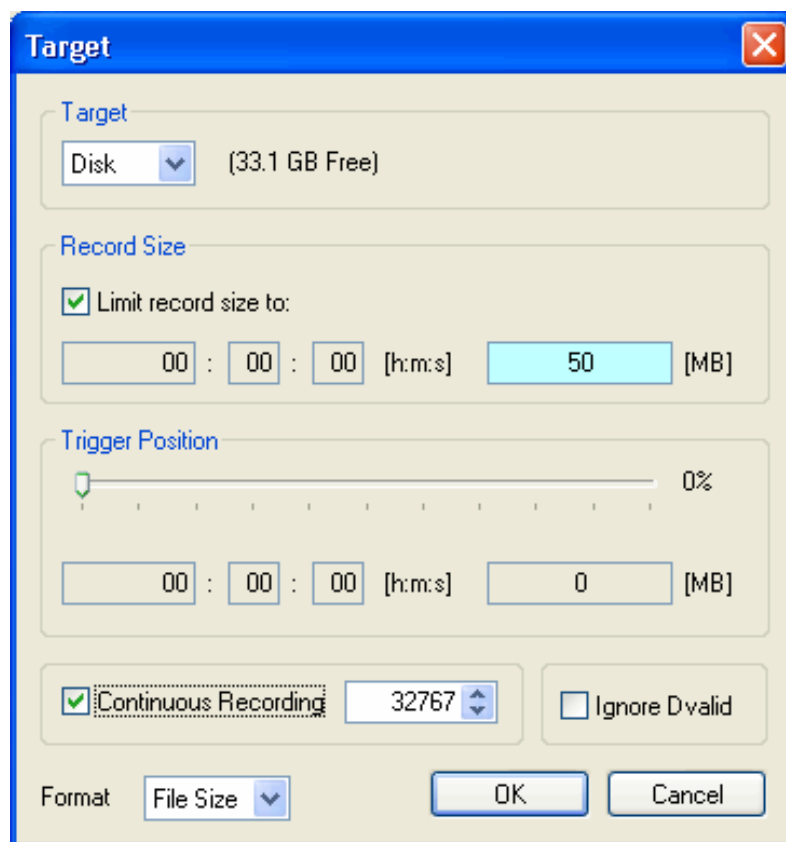

5. To the right of the check box, set the number of files to be continuously recorded. After the specified number of files are created, stream capture stops automatically.
6. In the **Record Size** field, set the file size to be recorded.
7. In the **Trigger Position** field, set the trigger position.

8. If you want to start recording by a trigger signal on the External Trigger connector:
  - a. Select **Record > Other** to open the **Others** dialog box.
  - b. Select **Rise** or **Fall** in the **Ext Record Start** field.
9. Select the Record button to start continuous recording.

While Continuous Recording is running, the total number of captured files are displayed in the file counter on the record status indicator.

When the specified number of files are created or you press the front-panel STOP button, stream capture stops.

After the stream capture stops, recording of the captured streams starts. The file counter value decreases every time recording of each file is complete. The recording starts from the last captured file. If you press the STOP button while the captured streams are recording, the recording process terminates to the file currently being recorded.

---

**NOTE.** *The error message Drive Full appears when there is no space to record a captured file with the specified file size on the hard disk.*

---

## Remote Commands

The MPEG Player can be controlled remotely through the 100/10 BASE-T port on the MTS400 Series rear panel.

The set of remote commands is described in the MTS400 Series Programmer Manual (071-1725-xx). This is supplied as a PDF file on the MTS400 documentation (063-3857-xx) CD-ROM.

Refer to the *Getting Started Manual* (071-1505-xx) for information about how to set up the MTS400 Series for remote operation of the MPEG Player.





# **Make Seamless Wizard**





# Table of Contents

<b>Make Seamless Wizard</b> .....	<b>11-1</b>
Starting the Wizard .....	11-1
Selecting an Input File .....	11-2
Select a Program to Make Seamless .....	11-7
Selecting a Multiplex Output File .....	11-10





# Make Seamless Wizard

This wizard guides you through the process of creating an MPEG-2 file for use by Stream Player in continuously looped operation.

The wizard is largely self-explanatory. The notes in this section of the manual provide a slightly more detailed explanation of the wizard and the necessary user responses.

## Starting the Wizard

To start the wizard, select the Make Seamless option from the Start menu. Alternatively, double-click on the Make Seamless shortcut on the desktop.

The opening window is displayed:

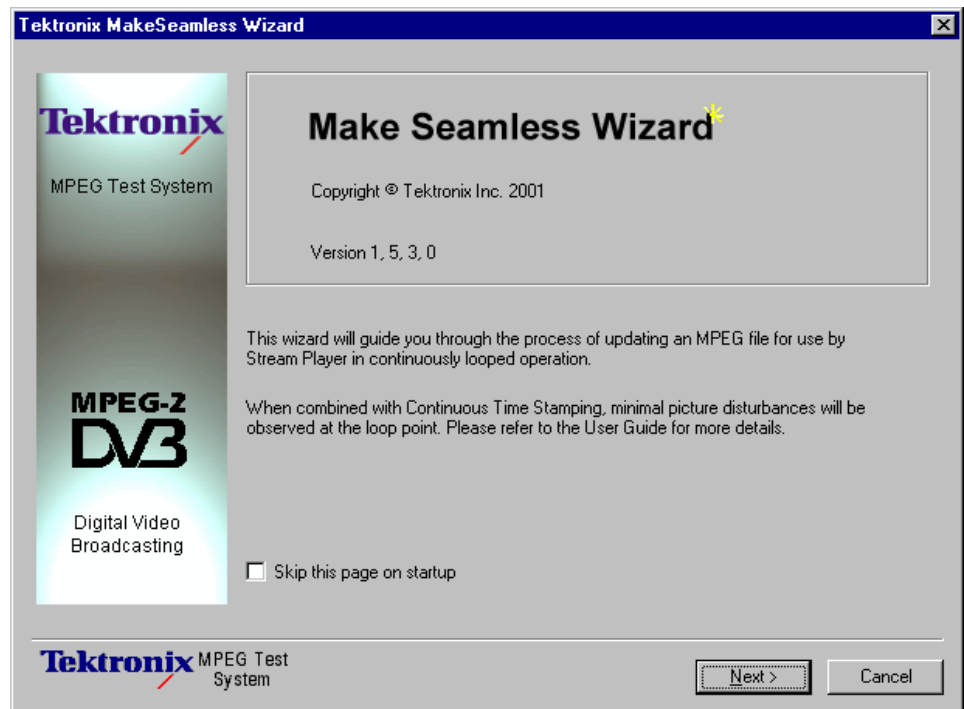

This first page gives a short explanation of the wizard's activities and offers the opportunity to skip the page in the future.



Select Next to move to the next screen and specify the input file.

**Progress and Information Log**

The Progress and Information log displays messages during the operation of the wizard. Three types of message can be displayed:

INFO	General processing information.
WARNING	Messages which may mean that the output stream will contain errors.
ERROR	Messages indicating catastrophic information which will cause the wizard to disable the Next button and prevent further progress.

An icon is displayed in the top right corner of the window and as a prefix to any messages displayed in the Progress & Information log. The icons are used to indicate the current processing phase of the Make Seamless Wizard:

Program                       Analysis                       Multiplex 

**Selecting an Input File**

The first action is to identify the input or source transport stream.

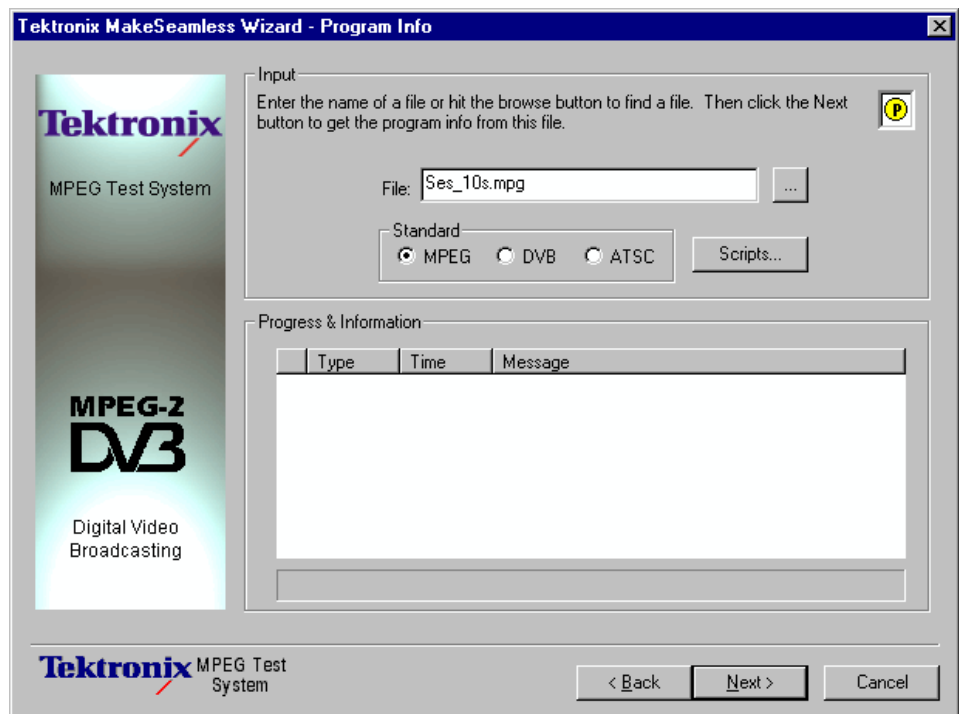

Enter the filename in the File: field. The browse button (...) can be used to open a standard Windows Open dialog box and locate files.

---

**NOTE.** Only the filename will be shown, but by resting the cursor over the filename, the full path is shown for a short time in a tooltip.

---

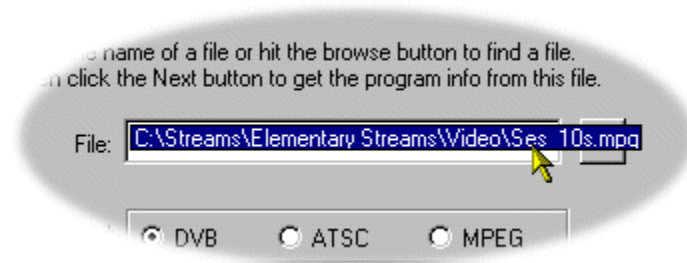

### SI Scripts

Customized SI scripts are available to the Make Seamless Wizard to enable custom SI table and descriptor data to be processed successfully. Basic processing of the Standards does not require additional scripts.

If a suitably configured script is selected and enabled before a stream is analyzed, custom data will be analyzed when the stream is opened. If the script is not selected or enabled, the stream will not fail to be analyzed, but any custom data will either be ignored or reported as an error in the stream configuration.

(The underlying principles of scripting are described in the Custom SI Scripting section of this user manual.)

**Handling Script Files.** To handle SI Scripts, select the general Standard required by enabling the appropriate radio button and select the **Scripts...** button.

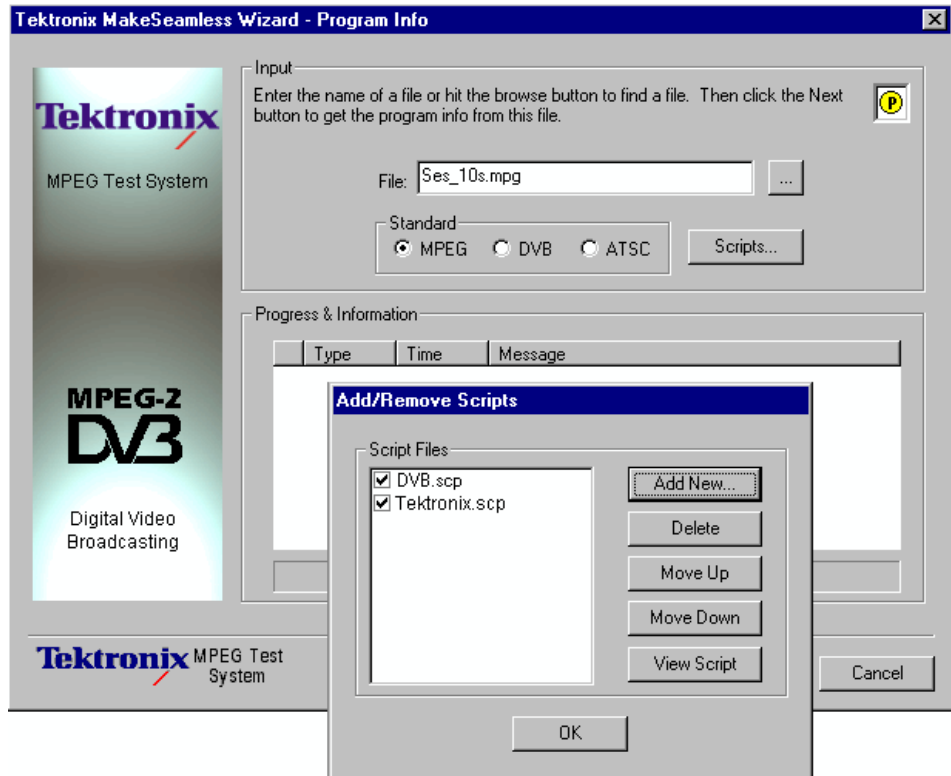

The Script dialog box displays the scripts currently associated with each standard and allows them to be added, removed, viewed, and manipulated.



There is, in effect, one Script File list associated with each mode; script files can be listed in one or more Script file lists. Script files are designated as MPEG, DVB or ATSC when they are added to the Script File list. Each mode will display only those script files associated with that mode. Further script files can be added as required using the **Add New...** button.

Note that a script file will not be used for analysis until:

- It is added to the Script File list in the appropriate mode.
- It is enabled (displays a check mark in the Script File list).

#### **Adding a Script File.**

1. In the Script dialog box, select the Mode to which the script is to be added; for example, DVB.
2. Select the **Add New...** button. A standard Windows file selection dialog box is opened. The default file extension is .scp. Select the required file.

Note that the selected script file is now listed in the script file list and is enabled; it will be used for any analysis.

**Enabling a Script File.** Select the check mark adjacent to the required script file to enable the file for analysis.

**Moving a Script File.** Script files are applied to analysis in the order that they are listed; in some circumstances this may be important. To move a file in a list, highlight the file name and select the Move Up or Move Down button as required. Each press of the button will move the file up or down one place in the list until it reaches the top or the bottom.

**Viewing a Script File.** Script files can be viewed and edited in a text editor (provided that the scp extension has been associated correctly in Windows Explorer). To edit a script, highlight the script name and select View. This will open the script in Notepad or its equivalent. The required edits can then be made and the script saved.

When the filename is satisfactory and any scripting actions have been performed, select Next to analyze the file. Progress is indicated by the progress bar and the appearance of messages in the Progress & Information log.

## Select a Program to Make Seamless

During the input file's analysis the selected transport stream is analyzed to determine its program content. If analysis is unsuccessful in determining program content, the stream will not be opened and an appropriate message will be displayed in the Progress & Information log.

Each program found is displayed in the drop-down list (**Program:**) accompanied by an indication of the number of program elements (video, audio, etc.).

At this stage a priority program must be selected in order for it to be analyzed and tested for suitability for the “make seamless” treatment.

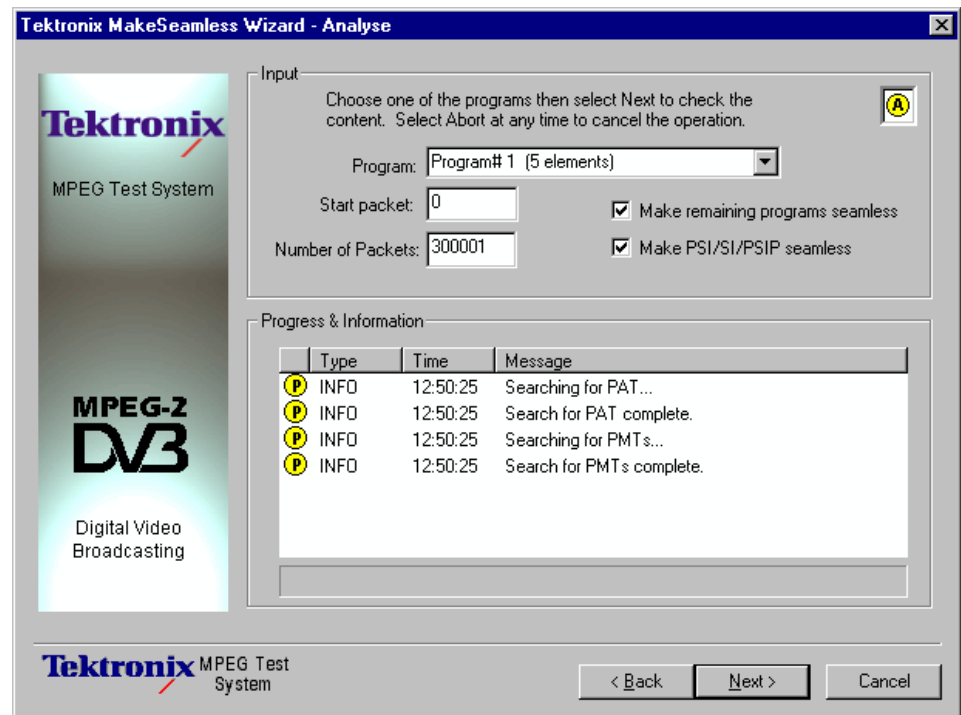

**Program:** Highlight the required program from the drop-down list.

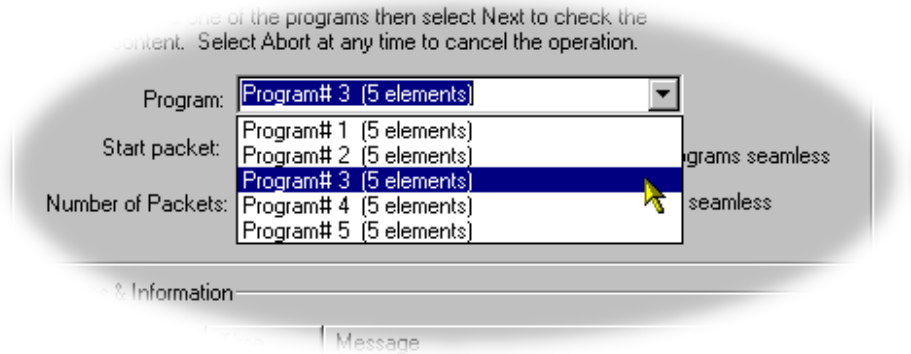

**Start packet:** This value determines from where the primary program is to be analyzed. Indicates the offset from the original transport stream start point to start looking for a loop start point.

**Number of Packets:** Initially, this value is set to the total number of packets in the transport stream. It indicates the maximum number of packets (up to the end of the stream) from the Start packet point that may be included in the loop.

**Make remaining programs seamless**

If enabled, the remaining programs are made seamless but are constrained by limits defined by the priority program. This may lead to these remaining programs having a gap at the beginning and end of the file.

**Make PSI/SI/PSIP seamless**

The service information contained in the transport stream is processed to make it seamless.

If this checkbox is not enabled, the SI is not processed but simply copied to the output transport stream.



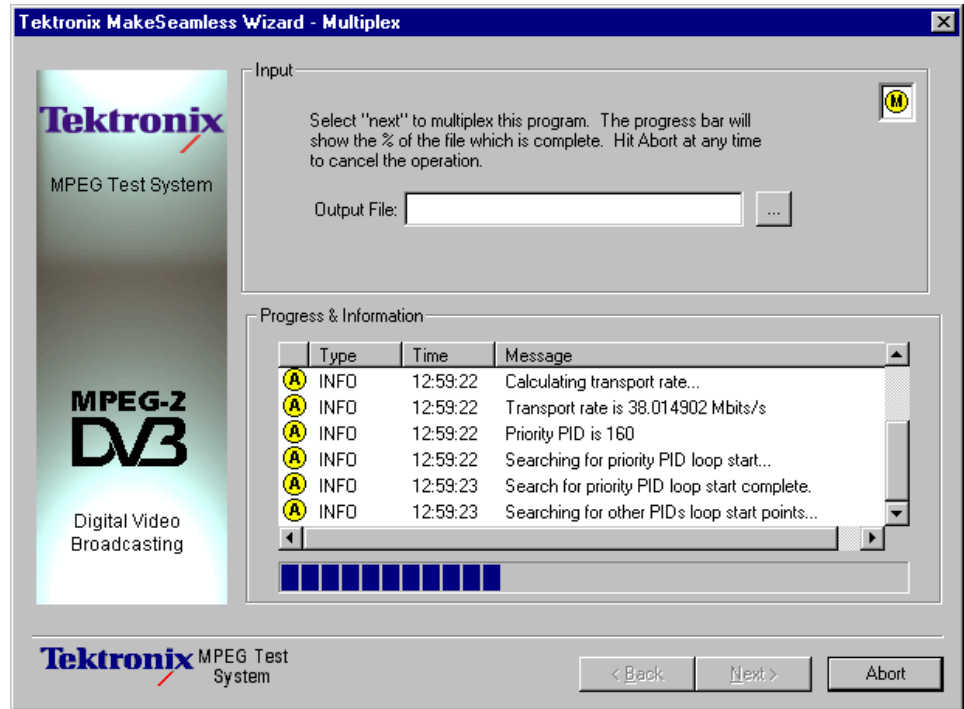

Select **Next**. Once again the progress bar will indicate progress. While the stream is being analyzed, selecting the **Abort** button will stop the process and allow the program to be reselected (Note that the Abort button, which replaces the Cancel button, is only displayed during processing).

When the file has been analyzed, a number of messages will have been posted in the Progress & Information log.

## Selecting a Multiplex Output File

When a file has been analyzed and found suitable for making seamless, an output file must be named.

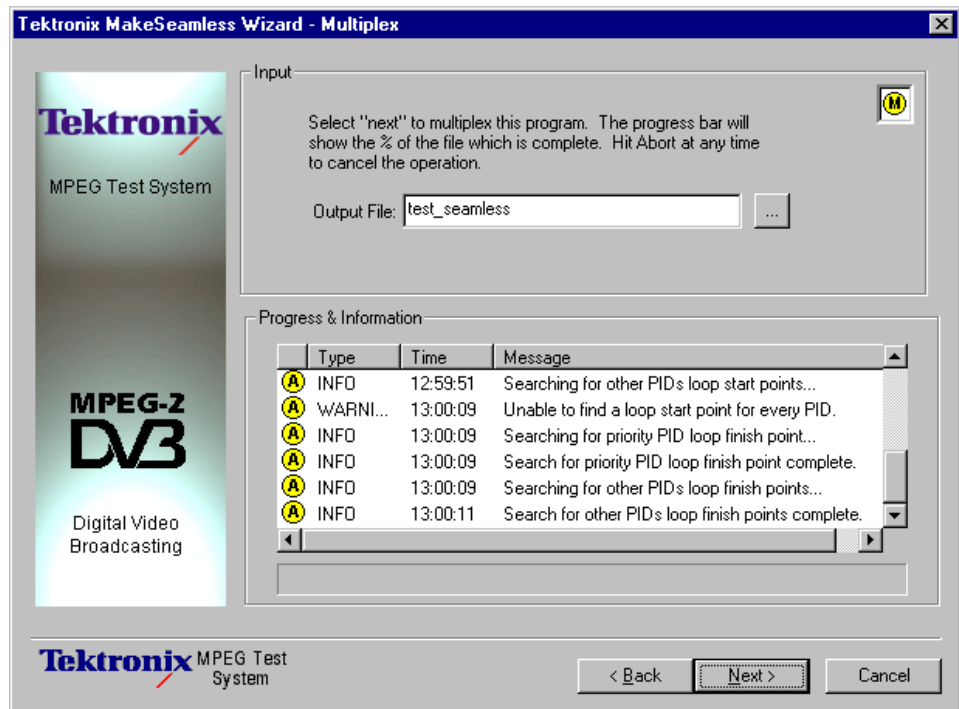

A new filename can be typed or an existing file selected using the Browse button (...), in which case confirmation of the replacement will be required. Select Next to create the multiplexed output file.

The screen shown below is displayed upon completion of the process.

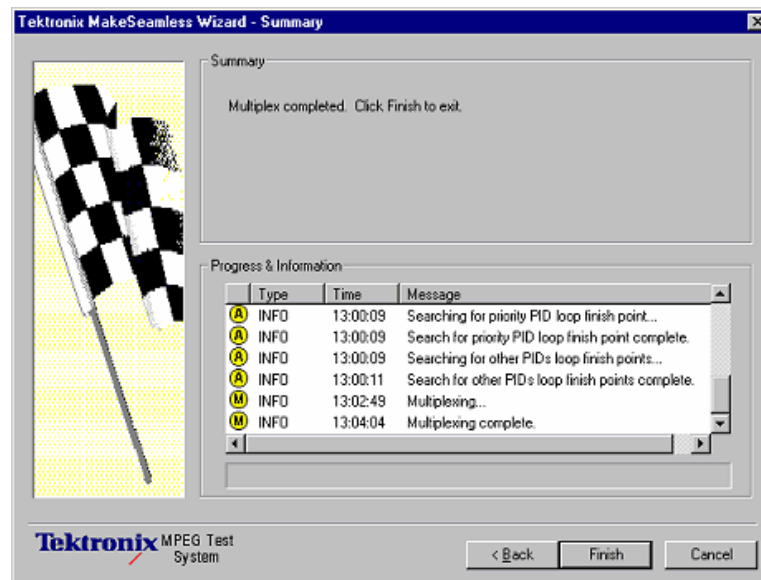
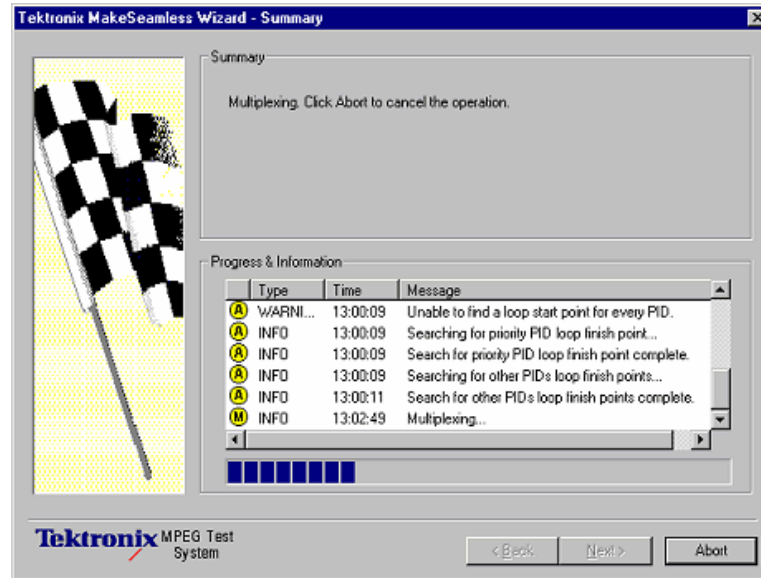

The output file will contain a program which when played out and looped with the Continuous Time Stamping option enabled will demonstrate minimal picture disturbances at the loop point.





# **Transport Stream Cutter**





# Table of Contents

<b>Transport Stream Cutter</b> .....	<b>12-1</b>
Starting the Wizard .....	12-1
Cutting a File .....	12-2





# Transport Stream Cutter

The Transport Stream Cutter is a wizard that creates a new file from a slice of an existing file. It is run from the Windows desktop. There are four pages including the optional introduction page:



## Starting the Wizard

The wizard may be started by selecting the **Tektronix TS Cutter** option from the **Tektronix Utilities** submenu of the **Start > Programs** menu.

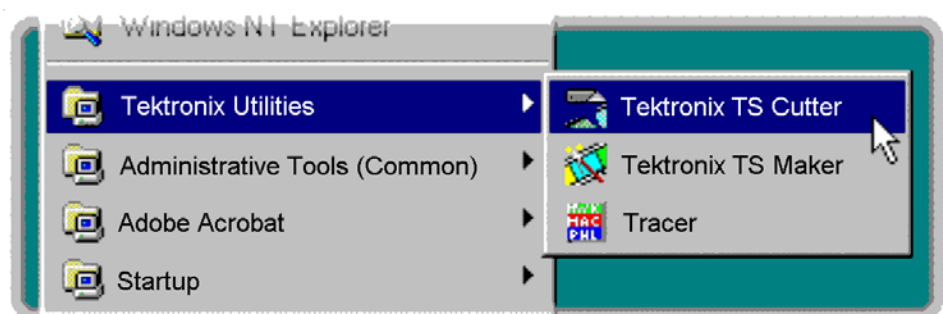

Alternatively, double-click on the **Tektronix TS Cutter** shortcut on the desktop.

## Cutting a File

By default the wizard will display this Introduction first.



The introductory page can be disabled by checking the **Skip this page on startup** option. Select the **Next** button to move on to Step 1.

Step 1 – Specify the name and location of the source file to copy a slice from:

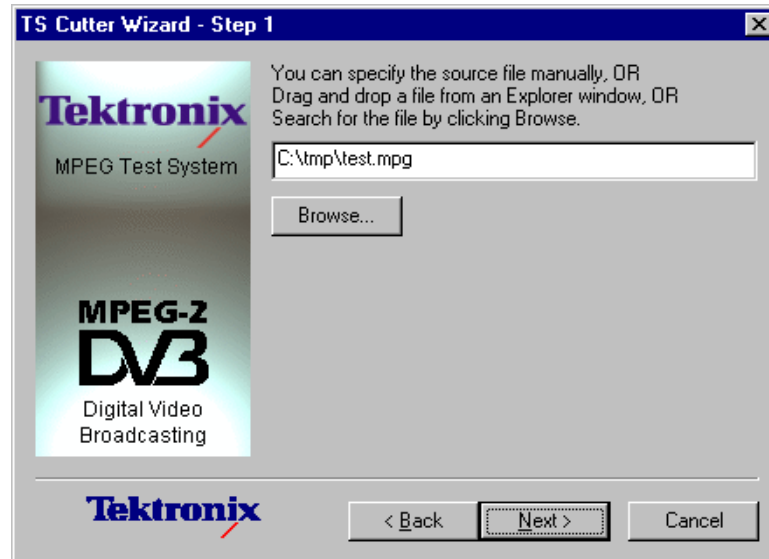

Select the **Browse...** button to open a standard file browser window to look for and choose the required file. Then select the **Next** button to move on to Step 2.

In step 2 the slice is specified by typing in the first packet and the number of packets to copy. The total number of packets in the file is also shown.

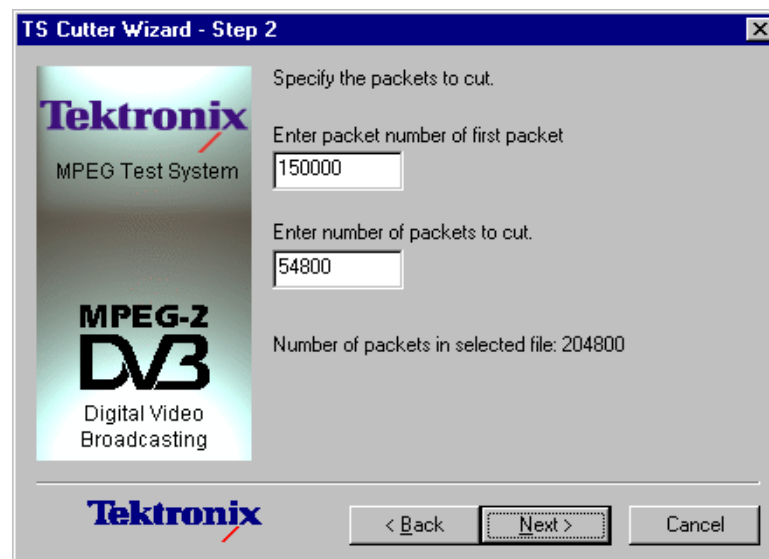

Selecting the **Back** button will return to Step 1 so that the source file name and location may be changed.

Step 3 is the last. Specify the name and location for the new file.

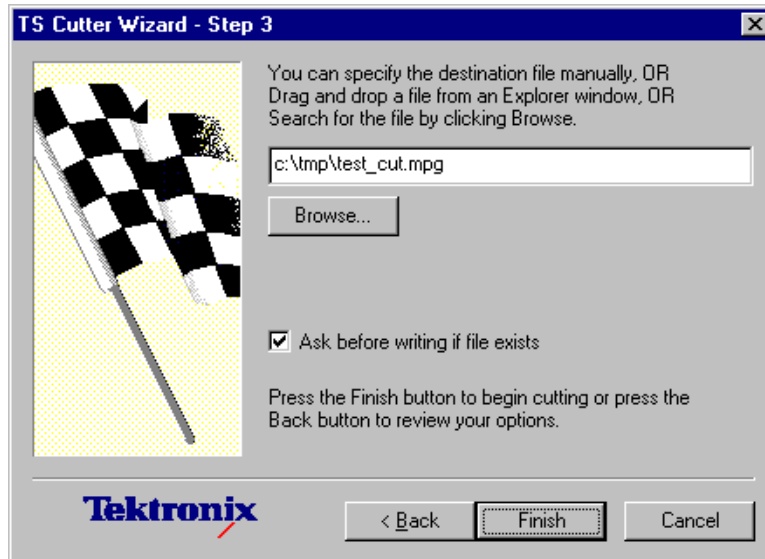

Select **Finish** to create the file and copy the required slice of data. Select **Back** to go back to change the source file, starting packet and number of packets.

The wizard now creates the new file and copies the selected data to the destination file specified. While it is working, this dialog box is displayed to indicate progress.

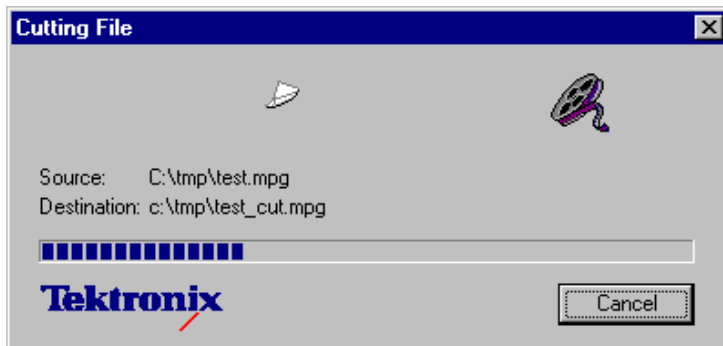

When the blue progress indicator reaches the right side the dialog box disappears and the file is ready to use.



# Script Pad



# Table of Contents

<b>Script Pad - Getting Started</b> .....	<b>13-1</b>
Setting Up .....	13-1
Starting the Program .....	13-1
Initial Appearance .....	13-2
Initial Menu Options .....	13-3
Script File Appearance .....	13-3
Opening a File .....	13-4
<b>Menu and Controls</b> .....	<b>13-7</b>
Menu Bar .....	13-7
Toolbar .....	13-9
Status Bar .....	13-10
<b>Script File Editing and Encryption</b> .....	<b>13-11</b>
Keyword Color-Coding .....	13-11
Parsing .....	13-11
Encryption .....	13-12

## List of Tables

<b>Table 13-1: File menu options</b> .....	<b>13-3</b>
<b>Table 13-2: File menu options</b> .....	<b>13-3</b>
<b>Table 13-3: File menu options</b> .....	<b>13-7</b>
<b>Table 13-4: Edit menu options</b> .....	<b>13-8</b>
<b>Table 13-5: View menu options</b> .....	<b>13-8</b>
<b>Table 13-6: Window menu options</b> .....	<b>13-8</b>
<b>Table 13-7: Script menu options</b> .....	<b>13-9</b>
<b>Table 13-8: Help menu options</b> .....	<b>13-9</b>



# Script Pad - Getting Started

ScriptPad is supplied with a number of Tektronix products to enable users to create and modify System Information (SI) scripts.

The rationale underlying SI Scripting is described elsewhere in this document; this section simply provides a guide to using ScriptPad.

It should be noted that script files are saved as ASCII files and that any ASCII text editor can be used to view and modify the files (for example, Microsoft Notepad). However, features such as color-coding of keywords and syntax checking will not be available; also access to encrypted script files will not be possible.

## Setting Up

The ScriptPad utility is installed automatically when the system is set up. There is no additional specific set up procedure. Simple user interface management is performed from within the utility.

## Starting the Program

ScriptPad is most often started by double-clicking an existing script file. The necessary file associations (\*.scp and \*.scx) are made automatically during the installation process.

Alternatively, you can start ScriptPad by clicking a shortcut placed on the desktop or by selecting ScriptPad in the Start menu in the taskbar.

## Initial Appearance

When the program has started and is ready for use, the main window is displayed, as shown below:

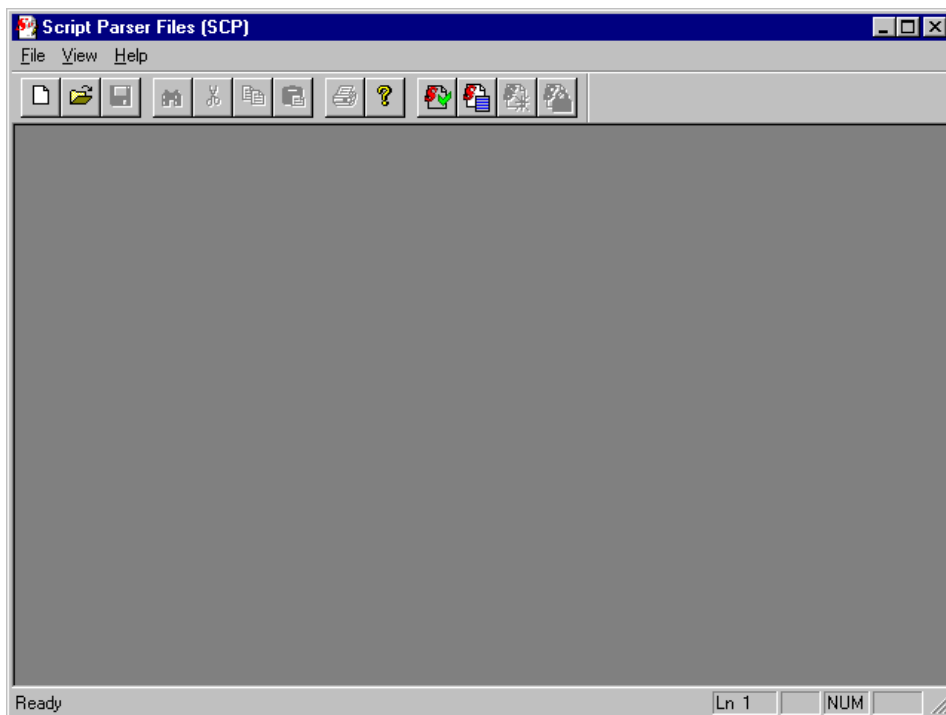

The Toolbar (row of buttons above the dark gray area of the empty window) may be hidden from view, moved to a separate window, either side or the bottom of the main window.

The Status Line at the very bottom of the window may be hidden from view.

The dark gray area constitutes the Working Area.

## Initial Menu Options

**File Menu Options** Table 13–1 lists the initial File menu options.

**Table 13–1: File menu options**

Option	Function
<b>New</b>	Opens a new file.
<b>Open...</b>	Opens a script file (*.scp) for analysis. Choose the required file.
<b>Print Setup...</b>	Select which printer and associated options to use.
<b>1 &lt;filename&gt;</b> <b>2 &lt;filename&gt;</b> <b>3 &lt;filename&gt;</b> <b>4 &lt;filename&gt;</b>	A list of the four most recently analyzed files. If the program has recently been installed; the list may be empty or hold less than four files.  Selecting a filename opens that file for analysis.
<b>Exit</b>	Closes the program.

**View Menu Options** Table 13–2 lists the initial View menu options.

**Table 13–2: File menu options**

Option	Function
<b>Toolbar</b>	Shows or hides the toolbar.
<b>Status Bar</b>	Shows or hides the status bar.

Select an option to change its status.

## Script File Appearance

Scripts displayed in Script Pad are color-coded to aid understanding.

Script Pad makes no formatting corrections or changes; it is recommended that script authors use conventional programming layout.

Single line comments are prefixed with a double slash (//); in ScriptPad they are colored green. Multi-line comments of the form /\*...\*/ are also accepted by the parser.

## Opening a File

Any script file (\*.scp or \*.scx) can be opened for viewing and editing by this program.

To open a file, select the **Open...** option from the file menu. If the required file is in the list of recently analyzed files, then it can be opened from the list.



Alternatively, use the Ctrl+O keyboard shortcut.

There is also a shortcut button available on the Toolbar for opening a file, which has the standard file open symbol.

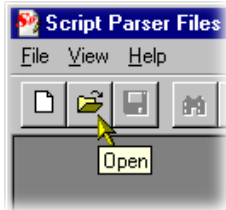

On opening, the script file is displayed in the working area.

```

//
// File      : DVB.scp
// Description : SCP Script for DVB Tables - see EN 300 468 v1.3.1
//
//          IMPORTANT NOTE - This script file contains the standard
//          definition of the DVB tables. Change COPIES of this script
//          and not the original. Copies should have this note removed.
//
// $Revision: 17 $
// $Modtime: 12/04/00 5:27p $
//
// Change History
//
// 15/3/99   K Skilling   CREATED
// 2/8/00    M Norman    Updated to a038r1
// 27/9/00   M White     Updated validation and formatting
//
// =====
#include "DVBEnums.scp"
#include "DVBDescriptors.scp"

// Override default to allow MPEG and DVB to be used together
// Built in default is DVB only

validation descriptor_tag
{
    [[descriptor_tag >= 0x40 && [descriptor_tag <= 0xFE]] ||
    [[descriptor_tag >= 0x02] && [descriptor_tag <= 0x15]]
}

```

Viewing and editing can start immediately. Note that multiple script files can be open simultaneously.



# Menu and Controls

The following pages contain descriptions of the menu options, toolbar controls, and status bar.

## Menu Bar

Different menus and options are presented before and after file opening and depending upon whether the file window or the message window is active.

The Menu Bar offers all of the options available currently. Options are context sensitive; they will only be available where relevant. Some options are also available through keyboard shortcuts; these are indicated on the menus.

A check mark next to an option indicates that the function is currently visible or active; no check mark means that it is hidden or inactive.

### File Menu Options

Table 13–3 list the File menu options.

**Table 13–3: File menu options**

Option	Function
<b>New</b>	Opens a new file.
<b>Open...</b>	Opens a script file (*.scp) for analysis. The program opens the file selection dialog box allowing the user to choose the required file.
<b>Close</b>	Closes the active script file window.
<b>Save</b>	Saves the active script file window.
<b>Save As...</b>	Allows the active script file to be saved under a different file name.
<b>Encrypt</b>	When enabled, scripts will be saved in encrypted format (*.scx) and unencrypted format (*.scp).
<b>Print...</b>	Opens Print dialog.
<b>Print Preview</b>	Previews print using current print settings.
<b>Print Setup...</b>	Opens a dialog for selecting which printer and associated options to use.
<b>1 &lt;filename&gt; 2 &lt;filename&gt; 3 &lt;filename&gt; 4 &lt;filename&gt;</b>	A list of the four most recently analyzed files. If the program has recently been installed the list may be empty or hold less than 4 files.  Selecting a filename opens that file for analysis.
<b>Exit</b>	Exits the program. The user is given the opportunity to save any changed script files.

**Edit Menu Options** Table 13–4 lists the Edit menu options.

**Table 13–4: Edit menu options**

Option	Function
<b>Cut</b>	Delete the currently highlighted text and move it to the clipboard.
<b>Copy</b>	Copy the currently highlighted text to the clipboard.
<b>Paste</b>	Paste the contents of the clipboard to the current cursor location.
<b>Find...</b>	Finds and highlights the text string entered in the Find dialog.
<b>Replace...</b>	Finds and replaces the text string entered in the Replace dialog.
<b>Go To...</b>	Places the cursor at the specified line number.

**View Menu Options** Table 13–5 lists the View menu options.

**Table 13–5: View menu options**

Option	Function
<b>Toolbar</b>	Shows or hides the Toolbar.
<b>Status Bar</b>	Shows or hides the Status Bar.
<b>Auto Syntax Highlights</b>	When enabled, automatically color-codes keywords in the active file as they are typed during editing.
<b>Refresh Syntax Colors</b>	Refreshes color coding of keywords in the active file.

**Window Menu Options** Table 13–6 lists the Window menu options.

**Table 13–6: Window menu options**

Option	Function
<b>New Window</b>	Opens a new empty window.
<b>Cascade</b>	Cascades all open windows in the application.
<b>Tile</b>	Tiles all open windows in the application.
<b>Arrange Icons</b>	Aligns icons of any minimized windows at the bottom of the program's main window.
<b>1 &lt;window title&gt;</b>	List the currently open windows. The active (visible) window is indicated by the checkmark.



**Script Menu Options** Table 13–7 lists the Script menu options.

**Table 13–7: Script menu options**

Option	Function
<b>Parse</b>	Parses the script file to check for syntax errors.
<b>Script Message Log</b>	Opens the parser message window.

**Help Menu Options** Table 13–8 lists the Help menu options.









**Table 13–8: Help menu options**





Option	Function
<b>About ScriptPad...</b>	Opens the About dialog which displays the program version number.

## Toolbar



The Toolbar provides a set of convenient shortcuts for the more frequently used menu options. The available commands are:

	Open a new file.
	Allows an existing script file to be selected and opened.
	Saves the active script file.
	Finds specified text.
	Allows the currently selected text to be cut. It can then be pasted to another location.
	Allows the currently selected text to be copied. It can then be posted to another location.
	Allows text currently held on the clipboard (having been previously cut or copied from elsewhere) to be pasted to the cursor location.
	Allows the active script to be printed.

	Opens the About ScriptPad dialog.
	Parses the currently active script for syntax errors.
	Toggles the display of the Script Parser Messages window.
	Allows the color-coded highlights in the active script to be refreshed.
	Enables encryption. Scripts saved while this function is enabled will be saved in encrypted format (*.scx) and encrypted format (*.scp).

The Toolbar can be dragged off the edge of the main window into a floating pallet. To do this click on the background inside the Toolbar, that is, not on one of the buttons, and drag into the main window area. The result is a self contained window which looks like this:

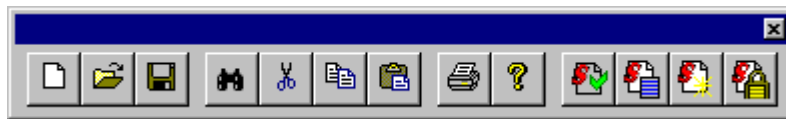

To replace the Toolbar on the window border drag it over the border until the outline changes shape. It can be placed on the top, bottom, left or right edges.

## Status Bar

The Status Bar displays an information message when the cursor is placed over any toolbar button or menu option.

# Script File Editing and Encryption

Because script files are saved as ASCII files, editing follows normal text editing customs. However, ScriptPad does provide extra features to enhance and verify the process.

## Keyword Color-Coding

When the **Auto Syntax Highlights** option in the **View** menu is enabled, keywords are automatically color-coded as they are typed.

When the **Auto Syntax Highlights** option is disabled, the color-coding can be refreshed by selecting the **Refresh Syntax Colors** option in the **View** menu.

## Parsing

Script files can be syntactically checked by selecting the **Parse** option from the **Script** menu. A message box will indicate that errors were or were not found in the file. The Script Parser Message window will be automatically opened when the message is acknowledged.

### Script Parser Message Window

The Script Parser Messages window logs the parsing activities and provides errors and warnings when necessary.

The following icons are used in the message window.

 Information       Error       Warning

Double-clicking an error message will bring the associated script file window to the front of the display.

Messages can be cleared from the window by right-clicking anywhere within the message window and selecting **Clear messages**.

## Encryption

There are an increasing number of proprietary standards emerging whereby analysis is allowable (possibly subject to a licence fee), but the owner of the standard does not want the script file to be viewed by users. This is solved by using encrypted script files. The ScriptPad utility, which is used for creating and editing script files has an Encrypt option, such that a script file is saved in an unreadable encrypted format, that only the ScriptParser can interpret. ScriptPad is associated with the .scp and .scx suffixes used for unencrypted and encrypted scripts respectively during the installation process.

The script encryption process employs a robust, 128 bit symmetric-key algorithm based on the Feistel block cipher, which is similar to that used in the dongle encryption scheme. Additional functions have been included to increase the entropy of the cipher text.

Each time a script is encrypted, a unique file is generated. This makes it hard to determine the algorithm by making small changes to plain-text and then observing the change made to the cipher-text. In addition the cipher-text is protected from interference, meaning that changes to the cipher text are detected on decryption and the altered file will be rejected.

---

**NOTE.** *A dongle is a security or copy protection device that must be connected to an I/O port of the computer while the program is run. Programs that use a dongle may query the port at start-up and at programmed intervals thereafter, and terminate if it does not respond with the expected validation code.*

---



# Glossary



# Glossary

Accuracy	The closeness of the indicated value to the true value.
AIT	Application Information Table
ARIB	Association of Radio Industries and Businesses
ASCII	American Standard Code for Information Interchange
ATSC	Advanced Television Systems Committee
BER	Bit Error Rate
BIOP	Broadcast Inter-ORB (Object Request Broker) Protocol
CAT	Conditional Access Table (MPEG)
CDT	Carrier Definition Table
COFDM	Coded Orthogonal Frequency Division Multiplexing
CVCT	Cable Virtual Channel Table (ATSC)
DDB	Download Data Block
DII	DownloadInfoIndication message
DSI	DownloadServerInitiate message
DSM-CC	Digital Storage Media – Command and Control
DTS	Decoding Time Stamp
DTV	Digital Television
DVB	Digital Video Broadcasting
EIT	Event Information Table (DVB/ATSC)
ES	Elementary Stream
ETT	Extended Text Table (ATSC)
EVM	Error Vector Magnitude
ID	Identity
IOR	Interoperable Object Reference
JPEG	Joint Photographic Experts Group

MGT	Master Guide Table (ATSC)
MHP	Multimedia Home Platform
MMT	Modulation Mode Table
MPEG	Moving Picture Experts Group
NIT	Network Information Table (DVB)
PAT	Program Association Table (MPEG)
PES	Packetized Elementary Stream
PID	Packet IDentifier
PIT	Program Information Table (ATSC)
PMT	Program Map Table (MPEG)
PSI	Program Specific Information (MPEG)
PSIP	Program and System Information Protocol (ATSC)
PSK	Phase Shift Keying (RF interface)
PTS	Presentation Time Stamp
QAM	Quadrature Amplitude Modulation (RF interface)
RAID	Redundant Array of Independent Disks
RF	Radio Frequency
RRT	Regional Ratings Table (ATSC)
RST	Running Status Table (DVB)
SDT	Service Description Table (DVB)
SEI	Supplemental Enhancement Information (H.264)
SI	Service Information (DVB)
SIT	Satellite Information Table
SNR	Signal-to-Noise Ratio
STT	System Time Table (ATSC)
TDT	Time and Date Table (DVB)
TDT	Transponder Data Table (ATSC)
TNT	Transponder Name Table



TOT	Time Offset Table (DVB)
TS	Transport Stream
TSDT	Transport Streams Description Table
T-STD	Transport Stream System Target Decoder
TVCT	Terrestrial Virtual Channel Table (ATSC)
U-N	User to Network
U-U	User to User
UTC	Universal Co-ordinated Time
VCT	Virtual Channel Table (ATSC)
VSF	Vestigial Side Band (RF interface)
VUI	Video Usability Information (H.264)
XML	Extensible Markup Language

